

Curves and Corners



VERSA-LOK® Standard units have a unique ability to provide a wide range of retaining wall curves and corners. Inside (concave), outside (convex) and serpentine curves are constructed with the same basic VERSA-LOK units by simply changing the alignment of units in the wall.

The same Standard unit is used to build inside 90° corners. And, by sawing or splitting the solid unit, you can build structurally stable interlocked corners ranging from 25° (outside) to 140° (inside). This flexibility and adaptability is unmatched by any other modular retaining wall system.

CURVES

Concave, convex and serpentine VERSA-LOK walls are made simply by fanning or bringing the tails of the units together. The trapezoidal shape of Standard units allows for construction of various radiuses while maintaining structural stability and tight vertical joints at the face of the wall. If a wall contains both curves and corners, start at the corners and work into the curves. Complete the entire first (base) course before proceeding to the second.

The radius of a curve will change as wall height increases, due to the 3/4-inch setback in each course. This changing radius will shift how units line up with the units below. The unique VERSA-LOK hole-to-slot pinning system easily accommodates this variation in curves. VERSA-LOK units do not need to overlap exactly halfway over units below (half-bond). However, units should overlap the units below by at least four inches. Because bond can vary in VERSA-LOK walls, vertical joints at the face can, and always should be, tight fitting (no gapping).

TECHNICAL BULLETIN

This Technical Bulletin is the third in a series of informational papers that provide specific application ideas and installation tips for VERSA-LOK® Retaining Wall Systems. Additional information is available in our *Design & Installation Guidelines*.

The information, including technical and engineering data, figures, tables, designs, drawings, details, suggested procedures, and suggested specifications, presented in this publication is for general information only. While every effort has been made to ensure its accuracy, this information should not be used or relied upon for any application without verification of accuracy, suitability, and applicability for the use contemplated, which is the sole responsibility of the user. A final, project-specific design should be prepared by a qualified, licensed, professional engineer based on actual site conditions. VERSA-LOK Retaining Wall Systems disclaims any and all express or implied warranties of merchantability fitness for any general or particular purpose, trademark, or copyright in regard to information or products contained or referred to herein.

VERSA-LOK®
 Retaining Wall Systems
Solid Solutions.™

6348 Hwy. 36, Suite 1
 Oakdale, MN 55128
 (651) 770-3166
 (800) 770-4525
 (651) 770-4089 fax
www.versa-lok.com

CONVEX (OUTSIDE) CURVES

For convex curves, decrease space between backs of units, always keeping front joints tightly aligned. The minimum outside radius is 8' 0" without cutting any of the units (Figure 1). However, establishing a minimum radius for the top course of a few inches greater (8' 2" to 8' 4") is recommended to allow for creep, or in the event additional courses are added in the future. Because the units set back 3/4" per course, the radius of the curves becomes tighter as the wall increases in height; therefore, you need to "backward plan" the radius of the base course. The example below shows how to calculate the base course radius when the radius for the top course is known.

EXAMPLE

This example would be used only if you were building a four-foot-high convex curved wall and your desired radius at the face of the top course was 8' 2". The base course radius in this example would be 8' 7-1/4".

4-ft. wall = 8 courses (7 setbacks)
 1 setback = 3/4"; 7 setbacks = 5-1/4"
 Desired radius of finished wall: 8' 2"
 $8' 2" + 5-1/4" = 8' 7-1/4"$. This is your starting (base course) outside radius.

OUTSIDE CURVE TABLE

Wall height (in feet)	Number of courses	Bottom course outside radius	Minimum outside radius for top course
4 ft.	8	8' 7-1/4"	8' 2"
3.5 ft.	7	8' 6-1/2"	8' 2"
3 ft.	6	8' 5-3/4"	8' 2"
2.5 ft.	5	8' 5"	8' 2"
2 ft.	4	8' 4-1/4"	8' 2"
1.5 ft.	3	8' 3-1/2"	8' 2"
1 ft.	2	8' 2-3/4"	8' 2"
.5 ft.	1	8' 2"	8' 2"

FIGURE 1 Top Course Convex (Outside) Curve Plan

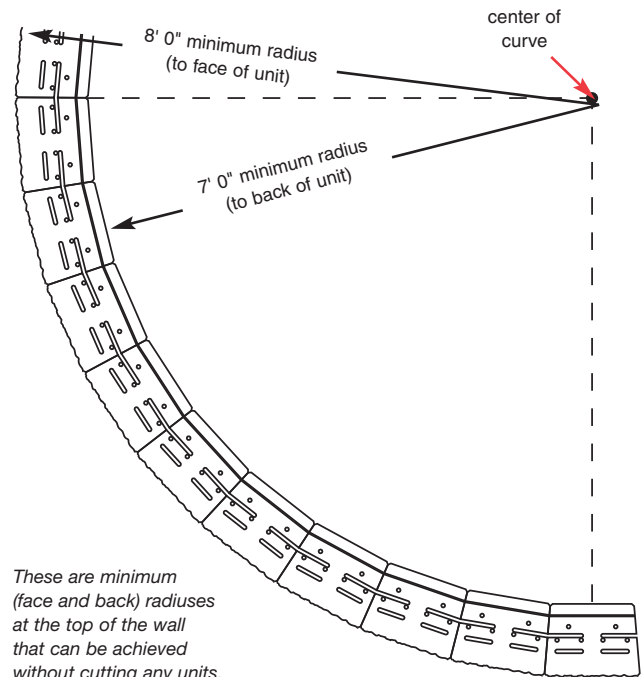

Careful base course planning for convex curves is important when building tight curves.

CONCAVE (INSIDE) CURVES

Concave curves are constructed by merely fanning (opening up) the spacing between the backs of adjacent units. The minimum recommended radius, as measured to the face of the wall, for an inside curve is 6' 0" at the bottom of a wall (Figure 2). Tighter curves can be built and pinned, but the appearance of the wall becomes ragged; structurally there is no problem.

FIGURE 2 Serpentine Wall Detail

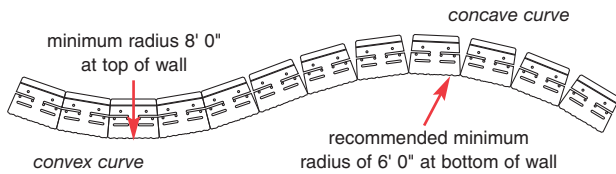

HOW TO LAY OUT A CURVE

1. Stake the center of the curve.
2. Swing layout line from center, marking the radius for bottom (base) course. See curve table.
3. Excavate and prepare base for the wall.
4. Place first unit on the radius desired.
5. Place adjacent units, check radius as you proceed.

CONVEX CURVE REINFORCEMENT

When placing geogrid behind convex curves, see Figure 3 for general reinforcement placement guidelines. For specific instructions, refer to geosynthetic manufacturer's guidelines.

FIGURE 3 Convex Curve

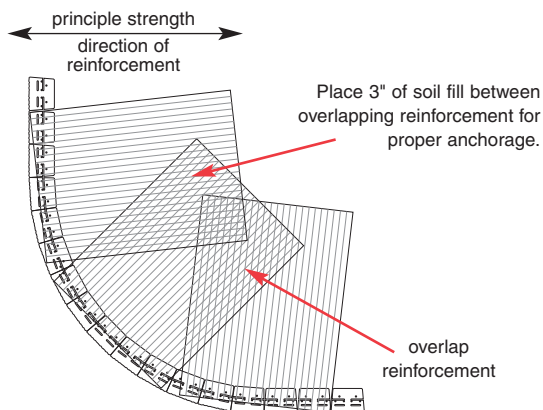

Build inside and outside curves with just one Standard VERSA-LOK unit—no specialty units needed.

CONCAVE CURVE REINFORCEMENT

When placing geogrid behind inside curves, simply diverge reinforcement from the face as shown in Figure 4. Place additional reinforcement on the course of units directly above the specified elevation (see dotted lines) so that it completely covers the gap. Keep successive layers of reinforcement from touching. Cover all gaps with reinforcement before backfilling.

FIGURE 4 Concave Curve

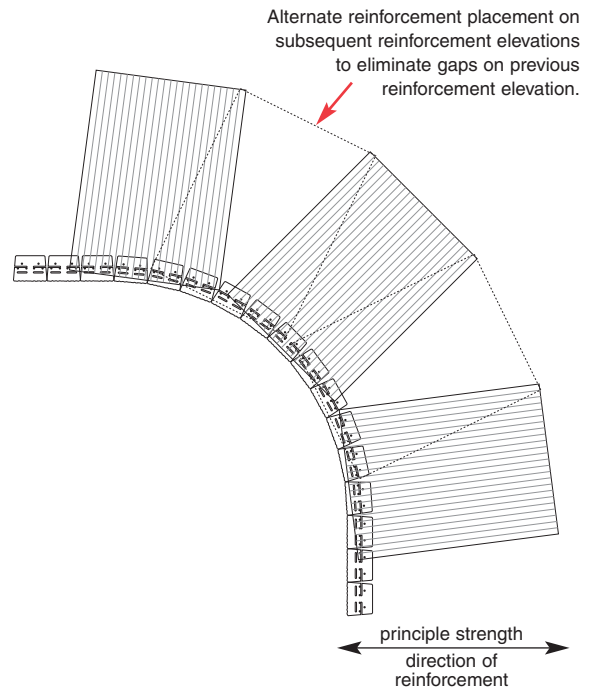

CORNERS

The solid, VERSA-LOK® Standard unit provides simplicity and flexibility for the construction of structurally stable corners. Not only does the VERSA-LOK system allow for easy construction of 90° inside and outside corners, but also for custom built corners at various angles.

When building walls with corners, always start at the corners and work out from there. Do not adjust length or gap at the corner. Instead, make adjustments away from the corner. Install partial units in the middle of the wall where they are less visible. Create these partial units by saw-cutting whole units into pieces at least four inches wide.

OUTSIDE 90° CORNERS

Start outside 90° corners by splitting a Standard unit in half and alternating half units at the corners as shown in Figure 5. Do not miter corners. Turn half units upside down at corners to conceal splitting groove. Adhere these half units to the wall using VERSA-LOK® Concrete Adhesive, as they will not pin. This corner detail creates about a four-inch overlap of the units below. As each additional course is setback 3/4-inch, this overlap will vary. The unique VERSA-LOK hole-to-slot pinning system allows vertical joints to wander. Units do NOT need to overlap exactly halfway over units below (half-bond). However, units should overlap units below by at least four inches.

FIGURE 5 Outside 90° Corner

Place half-units at corner upside down to conceal splitting groove.

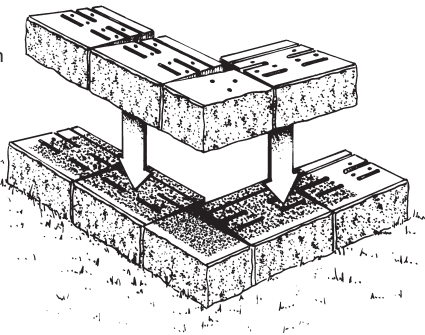

INSIDE 90° CORNERS

Half units are not required to start an inside corner; merely alternate the placement of a full-size VERSA-LOK unit past the inside corner (approximately 12" on the base course) as shown in Figure 6.



Curves, corners and a wide variety of steps are all possible with VERSA-LOK Standard units.



The alignment system of VERSA-LOK provides unmatched construction versatility.

FIGURE 6 Inside 90° Corner

Bond will gradually change due to 3/4" setback per course.

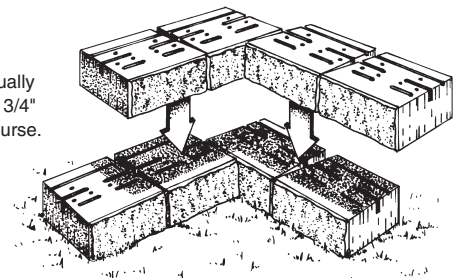

REINFORCEMENT PLACEMENT FOR CORNERS

For 90° outside corners, alternate the principle reinforcement direction whenever sections overlap (Figure 7). For 90° inside corners, extend geogrid past corners (Figure 8). Check your geosynthetic manufacturers' guidelines.

FIGURE 7 Outside Corner

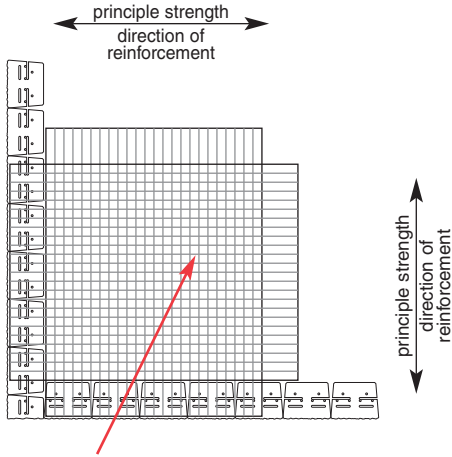

Place 3" of soil fill between overlapping reinforcement for proper anchorage.

FIGURE 8 Inside Corner

Alternate the extension of reinforcement at subsequent reinforcement elevations.

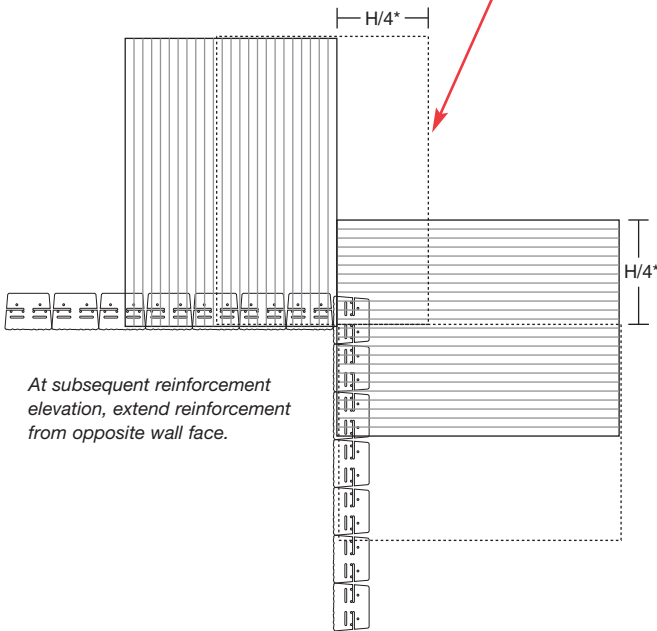

At subsequent reinforcement elevation, extend reinforcement from opposite wall face.

*Extend reinforcement beyond wall face at a distance equal to 1/4 of the height of the wall (H).

Example: H = 12' wall, extension = H/4 = 3'

SPECIALTY CORNERS

A variety of custom inside and outside corners (other than 90°) can be made with VERSA-LOK® Standard units. Use the illustrations provided in Figures 9 through 13A as guidelines when designing and building specialty corners.

The sets of illustrations for each corner arrangement represent alternate courses. Split the units where textured faces are desired and visible; saw cut the units when straight edges are needed to fit tightly next to adjacent units.

Alternating outside corner units should always overlap; do not butt or miter corners. If corners are butted or mitered, walls could separate at the corner due to ground movement.

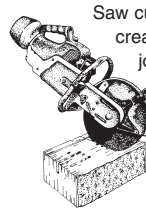

Saw cut partial units to create a smooth vertical joint for tight-fitting face joints.

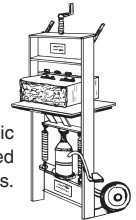

A portable hydraulic splitter creates textured split faces.



3

ADDITIONAL CUSTOM CORNERS

TECHNICAL BULLETIN

For more detailed information regarding design and installation, please contact your local dealer or **VERSA-LOK®** Retaining Wall Systems.

Made worldwide under license from **VERSA-LOK** Retaining Wall Systems. U.S. Patent D319,885, U.S. Patent D321,060, U.S. Patent D341,215, U.S. Patent D346,667, U.S. Patent D378,702, U.S. Patent D391,376, U.S. Patent D430,680, U.S. Patent D435,302, U.S. Patent D439,678, U.S. Patent D452,332, U.S. Patent D458,387, U.S. Patent 6,488,448 and other U.S. patents pending;

Canadian Industrial Design Registration No. 63929, No. 71472, No. 73910, No. 73911, No. 73912, No. 77816, No. 79058, No. 82288, and No. 89084.

I.C.B.O. No. 4625

©2003 Kiltie Corporation
Printed in U.S.A. • VLS-503

FIGURE 10 Low Angle Outside Corner

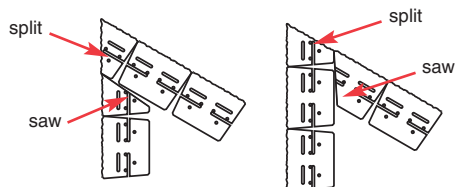

FIGURE 11 Near Right Angle Outside Corner

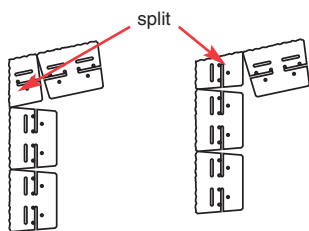

FIGURE 12 Low Angle Inside Corner

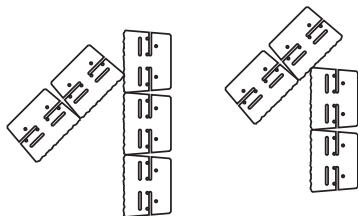

FIGURE 13 Large Angle Inside Corner

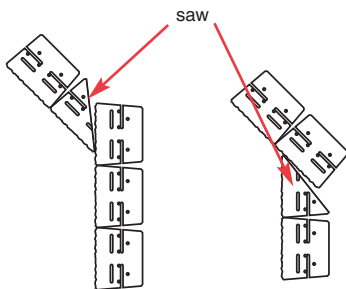

FIGURE 9 Large Angle Outside Corner

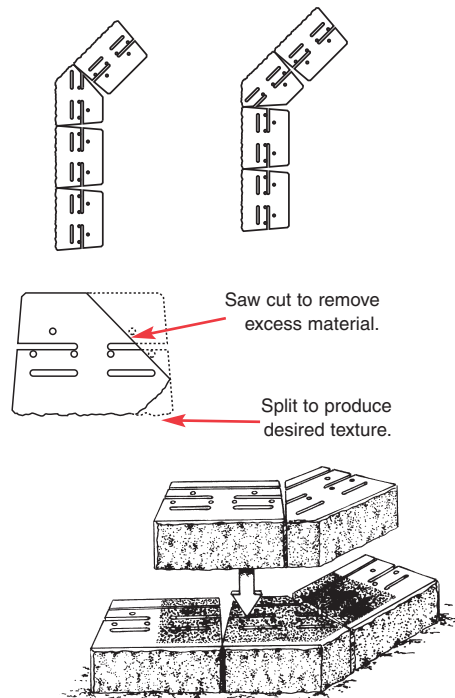
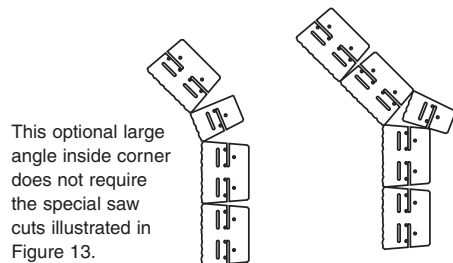
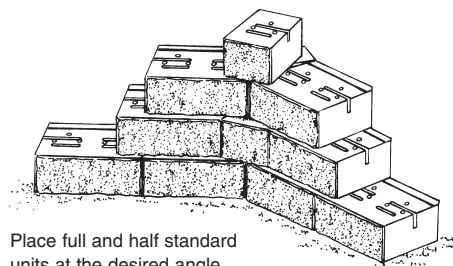

FIGURE 13A Large Angle Inside Corner (Optional)



This optional large angle inside corner does not require the special saw cuts illustrated in Figure 13.



Place full and half standard units at the desired angle.

VERSA-LOK®
Retaining Wall Systems
Solid Solutions.™

6348 Hwy. 36, Suite 1
Oakdale, MN 55128
(651) 770-3166
(800) 770-4525
(651) 770-4089 fax
www.versa-lok.com