



OBERFIELDS LLC
Sales - Corporate Office
 528 London Road
 P.O. Box 362
 Delaware, Ohio 43015-0362
 614-252-0955
 740-369-7644
 800-845-7644
 Fax 740-363-7644

**Sales and Manufacturing
 Landscape & Precast**
 1165 Alum Creek Drive
 Columbus, Ohio 43209
 614-252-0955
 Fax 614-252-5858

10075 Sheenan Road
 Centerville, OH 45458
 937-885-3711
 Fax 937-885-7965

980 Shawnee Road
 Lima, Ohio 45805
 419-225-6761
 Fax 419-225-6121

**Manufacturing
 Masonry**
 471 Kintner Parkway
 Sunbury, Ohio 43074
 4033 Alum Creek Drive
 Obetz, Ohio 43207



////////////////////////////////////
**OHIO'S LEADING MANUFACTURER,
 MARKETER, AND TECHNICAL
 RESOURCE FOR SUPERIOR QUALITY
 CONCRETE MASONRY PRODUCTS.**
 //////////////////////////////////////

WWW.OBERFIELDS.COM

CONCRETE PRODUCTS GROUP

OBERFIELDS LLC is one of 11 original founding members of the Concrete Products Group. The Concrete Products Group (CPG) consists of regional market leaders in the concrete products industry. The CPG is organized to provide consistent, top-quality products to regional and national customers, from a local regional plants to anywhere in the United States. Our products such as Spec-BRIK WCT (Water Control Technology), Spec-Finish, and Spec-Thermal are produced with consistent specifications and production expertise.

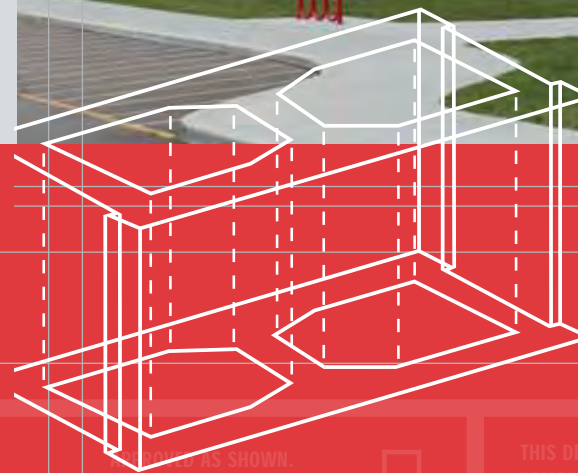

OBERFIELDS LLC IS A PROUD MEMBER OF:

- American Institute of Architects-Ohio
- The Builders Exchange of Central Ohio
- Building Industry Association of Central Ohio
- Construction Specification Institute
- National Concrete Masonry Association
- Ohio Masonry Association
- Concrete Products Group

APPROVED AS SHOWN.
 APPROVED AS NOTED.
 APPROVED BY. _____
 DATE APPROVED. // //

THIS DRAWING WITH ITS PRINCIPLES OF DESIGN CONTAINS PROPRIETARY AND CONFIDENTIAL INFORMATION OF OBERFIELD'S NOT TO BE USED, COPIED OR DISCLOSED WITHOUT WRITTEN PERMISSION PROTECTED UNDER U.S. AND FOREIGN COPYRIGHT LAW. ALL RIGHTS RESERVED.



OBERFIELDS LLC
 SOLID PERFORMANCE
 IN CONCRETE PRODUCTS

CONCRETE MASONRY PRODUCT GUIDE



NOTES

A

- Safety
- Technical Support
- Fire Ratings
- Unit Weight
- Sandblasted Concrete Masonry Units
- Scored Concrete Masonry Units
- Combination Cubes
- West Cubes
- Obtaining Samples
- Product Disclaimer
- Handling DesignBLOK™ Architectural Concrete Masonry Units on the Job

STANDARD CONCRETE MASONRY 1-11

- Miscellaneous Units 1
- Concrete Brick 1
- 4" Units and 4" Bullnose Units 1-2
- 6" Units and 6" Bullnose Units 2-4
- 8" Units and 8" Bullnose Units 4-7
- 10" Units and 10" Bullnose Units 7-8
- 12" Units and 12" Bullnose Units 8-10
- 14" and 16" Units 10-11

DESIGNBLOK™ ARCHITECTURAL CONCRETE MASONRY 11-20

- Split Face Units 11-14
- Scored Split Face Units 14-15
- Castle Rock® Units 15
- Shadow Stone® Units 16
- 3 Flute Split Face Units 16
- Deep 4 Flute Split Face Units 17
- Wide 4 Flute Split Face Units 17-18
- 6 Flute Split Face Units 18
- 8 Flute Split Face Units 18-19
- Stri-Face & Scored Stri-Face Units 19
- Solid Chamfered Sill Units 20
- ColossalBLOK™ Series 20
- SoundBLOX® 21
- Azar Mortarless Dry-Stack® 21-22
- Hi R Energy Wall System 22
- Artistry Series 22

CORNER AND PIER DETAILS 23-24

ESTIMATING GUIDES 25-26

DESIGNSTONE AUTO CAD DRAWINGS 27-29

MASONRY DESIGN SERVICE 30-32

NOTES

SAFETY

All OBERFIELDS concrete masonry units are manufactured in accordance with ASTM C-90, the industry standard for load bearing concrete masonry units.

Material Safety Data Sheets (MSDS) are available upon request from OBERFIELDS for the products listed in this Guide.

Please note, sawing or grinding of concrete masonry units may result in the release of dust particles, which could cause minor eye or nose irritation if proper protective equipment is not in place. The use of a NIOSH approved respirator and tight goggles is recommended when sawing or grinding operations are in progress. Please contact our Customer Service Center if further information is desired.

TECHNICAL SUPPORT

OBERFIELDS Technical Support Staff will gladly provide written quotations for all your special project needs. To expedite the process, have any dimensional constraints, drawings, and product requirements available for our review.

FIRE RATING

The fire ratings for the concrete masonry units in this Guide were calculated using the equivalent thickness method and based on the use of normal weight aggregates. References include ASTM C90, ASTM C140, TEK 7-1E, International Building Code 2009, and ASTM E119-08A.



Product Description	122	12" x 8" x 16" STRETCHER
Product Number		
Product Dimensions Inches/Millimeters	12" x 8" x 16"	
Ordering Information	UNIT WEIGHT: 51	
Fire Rating	STANDARD CUBE	
Product Illustration with Actual Dimensions	66 PER CUBE	
		RATED 3 HOURS

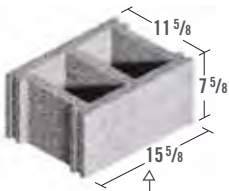

PACKAGE/CUBE CODE

- On pallet - 48" x 48" returnable wood pallet
- On 8s - 18 8" x 8" x 16" hollow core units
- Standard cube - these units are cubed on themselves
- Combination cube - contains different shapes in the same cube

UNIT WEIGHT

All weights shown represent OBERFIELDS standard normal weight (Rite-Blok) concrete masonry units manufactured from natural aggregates. Most shapes and sizes can be special ordered in lightweight (Lite-Blok) or medium weight (Mid-Blok). Please contact OBERFIELDS Technical Support Staff for additional information.

To estimate a given product's weight using lightweight or medium weight raw materials, use the following rule of thumb:

- Weight of lightweight product = standard normal weight x .85
- To obtain weight of normal weight product without limestone aggregate use normal weight x 1.05

SANDBLASTED CONCRETE MASONRY UNITS

Sandblasted concrete masonry units are available upon special order. Sandblasted units are manufactured such that the face surface of the unit is sandblasted. OBERFIELDS Technical Support Staff will gladly discuss design options and availability.

SCORED CONCRETE MASONRY UNITS

OBERFIELDS offers vertical scores, or false joints, on the majority of its standard concrete masonry units. Typically, one or three scores are preferred. Also, in some instances, both sides of the standard concrete masonry unit can be scored. OBERFIELDS Technical Support Staff will gladly discuss design options and availability.



COMBINATION CUBES

Please note on combination cubes that the ratio of one product to another varies from manufacturing plant to manufacturing plant due to differences in mold sizes and configurations. Please call our Technical Support Staff for additional information.

WEST CUBES

West cubes are available for some concrete masonry units. Please contact our Technical Support Staff for availability.

OBTAINING SAMPLES

Samples of colors, textures, weights, sizes, and shapes can be obtained from OBERFIELDS.

PRODUCT DISCLAIMER

The products shown in this Guide are computer-generated images. These images depict standard gray units. Some color differentiation should be expected with architectural concrete masonry units both smooth & split. Variations are to be expected. Should you require a product not cataloged in this Guide, contact our Technical Support Staff for the manufacturing lead time.

HANDLING DESIGNBLOK™ ARCHITECTURAL CONCRETE MASONRY UNITS ON THE JOB

When handling DesignBLOK™ architectural concrete masonry units on the job, avoid stacking palletized cubes one on top of the other. Pallet stain may occur other-wise. Also, given the demand for multiple colored units on the job, prevent the mixing of colors by checking for changes in colors of the units.

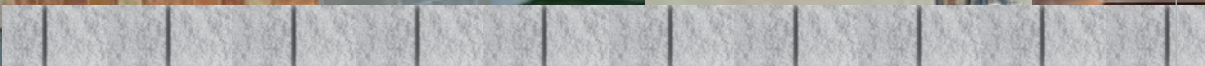
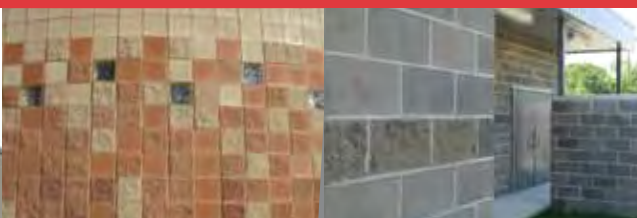

ORDERING SUGGESTIONS

The aesthetic beauty and structural characteristics that concrete masonry possess are being recognized and appreciated. It is important that units are ordered correctly the first time to insure the lowest overall cost, while achieving the finest quality and appearance.

1. Check for changes in quantity and color. With multiple colors, due to the use of accent bands and other color combinations, ordering by OBERFIELDS name and number will help to clarify your order.
2. By using OBERFIELDS Concrete Masonry Product Guide, you can order by OBERFIELDS product number to avoid confusion. If the need arises for a shape or size that is not currently cataloged, check with your salesperson or our Technical Support Staff for the manufacturing lead time. OBERFIELDS invites your requests for custom shapes, sizes, aggregates, textures, weights, and colors.
3. For special orders, contact OBERFIELDS Customer Service Department for lead time.
4. Special units such as corners and halves, correctly ordered at the beginning of the project, will aid in color uniformity.



MISCELLANEOUS

4 16" x 16" x 8" CHIMNEY

16" x 16" x 8"
406 x 406 x 203
UNIT WEIGHT: 61
ON PALLET
45 PER CUBE

CONCRETE BRICK

4"

12 4" x 8" x 12" SOLID

4" x 8" x 12"
102 x 203 x 305
UNIT WEIGHT: 23
ON PALLET
144 PER CUBE

15 4" x 4" x 16" DOUBLE END

4" x 4" x 16"
102 x 102 x 406
UNIT WEIGHT: 12
NON-STOCK

ON PALLET 288 PER CUBE

1 2" x 8" x 16" SOLID

2" x 8" x 16"
51 x 203 x 406
UNIT WEIGHT: 14
ON PALLET
216 PER CUBE

5 16" x 20" x 8" CHIMNEY

16" x 20" x 8"
406 x 508 x 203
UNIT WEIGHT: 75
ON PALLET
30 PER CUBE

8 2" x 4" x 8" CONCRETE BRICK

2" x 4" x 8"
51 x 102 x 203
UNIT WEIGHT: 5
ON PALLET
720 PER CUBE

10 4" x 4" x 16" SOLID FROGGED ON TOP

4" x 4" x 16"
102 x 102 x 406
UNIT WEIGHT: 15
ON PALLET
216 PER CUBE

13 4" x 8" x 16" SOLID

4" x 8" x 16"
102 x 203 x 406
UNIT WEIGHT: 31
ON PALLET OR ON 8s
108 PER CUBE

RATED 1.5 HOURS

16 4" x 4" x 16" DOUBLE END BREAKER

3 3" x 8" x 16" SOLID

3" x 8" x 16"
76 x 203 x 406
UNIT WEIGHT: 22
ON PALLET
144 PER CUBE

RATED .75 HOURS

6 10" x 20" x 8" CHIMNEY HALF BLOCK FOR 20" x 20" x 8"

10" x 20" x 8"
254 x 508 x 203
UNIT WEIGHT: 56
ON PALLET
40 PER CUBE

9 4" x 5" x 8" CONCRETE DOUBLE BRICK

4" x 5" x 8"
102 x 127 x 203
UNIT WEIGHT: 10
ON PALLET
378 PER CUBE

11 4" x 8" x 8" SOLID

4" x 8" x 8"
102 x 203 x 203
UNIT WEIGHT: 15
ON PALLET
216 PER CUBE

14 4" SOLID 45 DEGREE

4" x 8" x 11" x 3"
102 x 203 x 280 x 76
UNIT WEIGHT: 28
ON PALLET
90 PER CUBE



18 4" x 6" x 16" DOUBLE END

4" x 6" x 16"
102 x 152 x 406
UNIT WEIGHT: 15
NON-STOCK

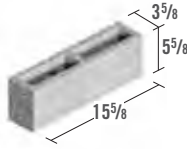

ON PALLET 216 PER CUBE

19 4" x 6" x 16" DOUBLE END BREAKER

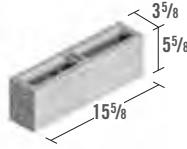

21 4" x 8" x 8" DOUBLE END

4" x 8" x 8"
102 x 203 x 203
UNIT WEIGHT: 11
ON PALLET
216 PER CUBE



22 4" x 8" x 12" DOUBLE END

4" x 8" x 12"
102 x 203 x 305
UNIT WEIGHT: 16
ON PALLET
144 PER CUBE

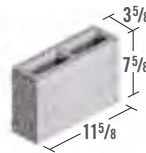

23 4" x 8" x 16" DOUBLE END

4" x 8" x 16"
102 x 203 x 406
UNIT WEIGHT: 23

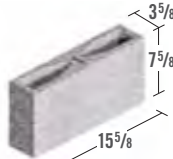
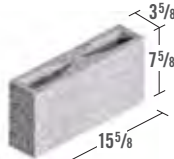

4" x 8" x 16"
102 x 203 x 406
UNIT WEIGHT: 24

RATED 1 HOUR

ON PALLET 144 PER CUBE

RATED 1 HOUR

4" BULLNOSE

25 4" x 8" x 8" SOLID SINGLE BULLNOSE & END

4" x 8" x 8"
102 x 203 x 203
UNIT WEIGHT: 16
ON PALLET
216 PER CUBE

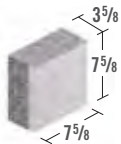

26 4" x 8" x 16" SOLID BULLNOSE ACROSS FACE

4" x 8" x 16"
102 x 203 x 406
UNIT WEIGHT: 31
ON PALLET
108 PER CUBE
NON-STOCK

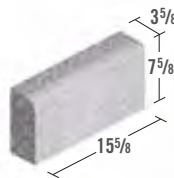

27 4" x 8" x 8" SINGLE BULLNOSE & END

4" x 8" x 8"
102 x 203 x 203
UNIT WEIGHT: 11
ON PALLET
216 PER CUBE



28 4" x 8" x 8" DOUBLE BULLNOSE & END

4" x 8" x 8"
102 x 203 x 203
UNIT WEIGHT: 11
ON PALLET
216 PER CUBE

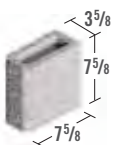

29 4" x 8" x 12" SINGLE BULLNOSE & END

4" x 8" x 12"
102 x 203 x 305
UNIT WEIGHT: 16
ON PALLET
144 PER CUBE

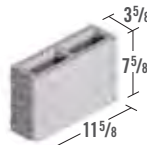

30 4" x 8" x 16" SINGLE BULLNOSE & END

4" x 8" x 16"
102 x 203 x 406
UNIT WEIGHT: 24
ON PALLET
144 PER CUBE

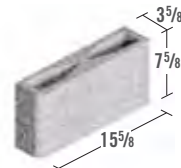

31 4" x 8" x 16" DOUBLE BULLNOSE & END

4" x 8" x 16"
102 x 203 x 406
UNIT WEIGHT: 24
ON PALLET
144 PER CUBE

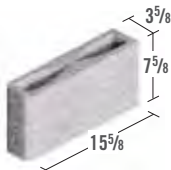

6"

32 6" x 8" x 16" SOLID

6" x 8" x 16"
152 x 203 x 406
UNIT WEIGHT: 46
ON PALLET
72 PER CUBE

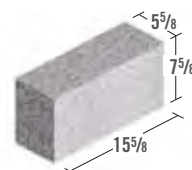

RATED 3 HOURS

33 6" x 4" x 16" DOUBLE END **34** 6" x 4" x 16" DOUBLE END BREAKER **35** 6" x 4" x 16" DOUBLE SASH BREAKER **35a** 6" x 4" x 16" SASH & END

6" x 4" x 16"
152 x 102 x 406
UNIT WEIGHT: 14
NON-STOCK

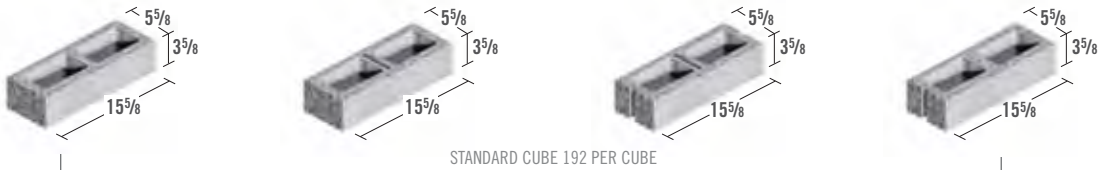

STANDARD CUBE 192 PER CUBE

37 6" x 6" x 16" DOUBLE END **38** 6" x 6" x 16" DOUBLE END BREAKER **39** 6" x 6" x 16" DOUBLE SASH BREAKER **39a** 6" x 6" x 16" SASH & END

6" x 6" x 16"
152 x 152 x 406
UNIT WEIGHT: 19
NON-STOCK

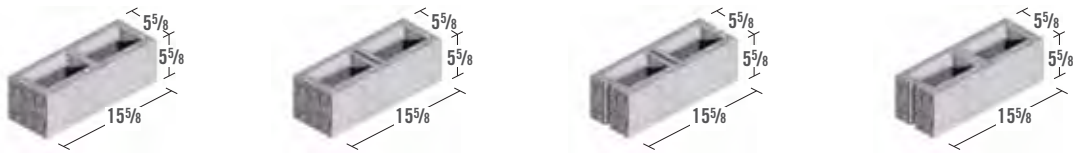

STANDARD CUBE 144 PER CUBE

41 6" x 8" x 8" SASH & END **42** 6" x 8" x 14" DOUBLE END

6" x 8" x 8"
152 x 203 x 203
UNIT WEIGHT: 17
ON PALLET
216 PER CUBE

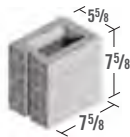

6" x 8" x 14"
152 x 203 x 356
UNIT WEIGHT: 23
ON PALLET
126 PER CUBE



43 6" x 8" x 16" DOUBLE END **44** 6" x 8" x 16" DOUBLE END BREAKER **45** 6" x 8" x 16" SASH & END **46** 6" x 8" x 16" DOUBLE SASH BREAKER

6" x 8" x 16"
152 x 203 x 406
UNIT WEIGHT: 28

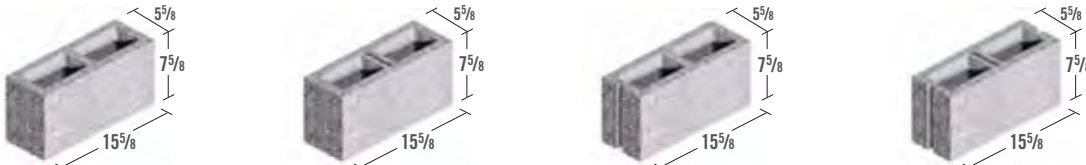

RATED 1 HOUR

STANDARD CUBE 108 PER CUBE

47 6" x 8" x 16" 67% SOLID DOUBLE END **48** 6" x 8" x 16" U BOND BEAM

6" x 8" x 16"
152 x 203 x 406
UNIT WEIGHT: 34
ON PALLET
72 PER CUBE
NON-STOCK

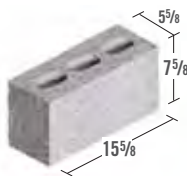

RATED 1.5 HOURS

6" x 8" x 16"
152 x 203 x 406
UNIT WEIGHT: 28
ON PALLET
96 PER CUBE

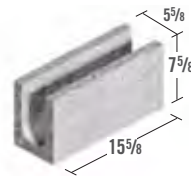

49 6" x 8" x 16" SOLID BULLNOSE ACROSS FACE **50** 6" x 8" x 8" SINGLE BULLNOSE & END

6" BULLNOSE

6" x 8" x 16"
152 x 203 x 406
UNIT WEIGHT: 46
ON PALLET
72 PER CUBE
NON-STOCK

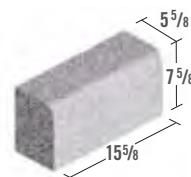

6" x 8" x 8"
152 x 203 x 203
UNIT WEIGHT: 17
ON PALLET
216 PER CUBE

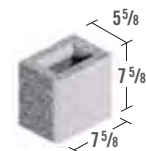



51 6" x 8" x 8" DOUBLE BULLNOSE & END

6" x 8" x 8"
152 x 203 x 203
UNIT WEIGHT: 17
ON PALLET
216 PER CUBE
NON-STOCK

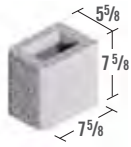

52 6" x 8" x 14" SINGLE BULLNOSE

6" x 8" x 14"
152 x 203 x 356
UNIT WEIGHT: 24
ON PALLET
126 PER CUBE
NON-STOCK

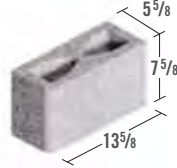

53 6" x 8" x 16" SINGLE BULLNOSE & END

6" x 8" x 16"
152 x 203 x 406
UNIT WEIGHT: 29
ON PALLET
108 PER CUBE



54 6" x 8" x 16" DOUBLE BULLNOSE & END

6" x 8" x 16"
152 x 203 x 406
UNIT WEIGHT: 29
ON PALLET
108 PER CUBE



8" UNITS

55 8" x 8" x 16" SOLID

8" x 8" x 16"
203 x 203 x 406
UNIT WEIGHT: 63
ON PALLET
54 PER CUBE

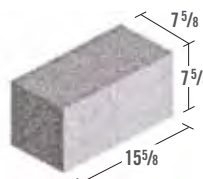

RATED 4 HOURS

56 8" x 8" x 16" SOLID HEADER

8" x 8" x 16"
203 x 203 x 406
UNIT WEIGHT: 48
ON 8s
72 PER CUBE

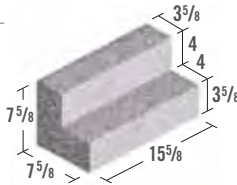

56a 8" x 8" x 16" OPEN CORE SOLID HEADER

8" x 8" x 16"
203 x 203 x 406
UNIT WEIGHT: 43
ON (18) 8" HC/COMBINED
(1 OUT OF 3)
72 PER CUBE

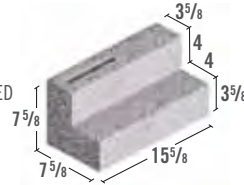

59 8" x 4" x 16" DOUBLE END*

60 8" x 4" x 16" DOUBLE END BREAKER*

61 8" x 4" x 16" SASH & END*

62 8" x 4" x 16" DOUBLE SASH BREAKER*

63 8" x 4" x 16" DOUBLE END*

8" x 4" x 16"
203 x 102 x 406
UNIT WEIGHT: 17

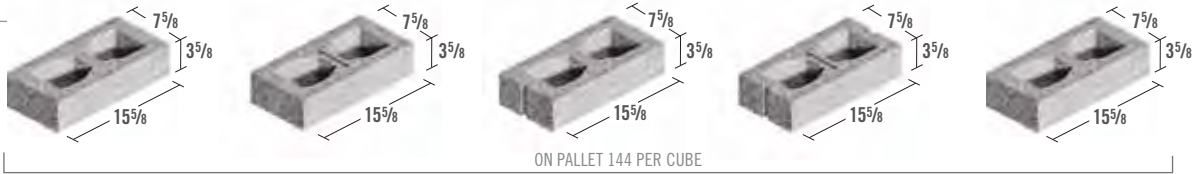

63a 8" x 4" x 16" RESTRICTED BOND BEAM

8" x 4" x 16"
203 x 102 x 406
UNIT WEIGHT: 17
ON PALLET
144 PER CUBE
NON-STOCK

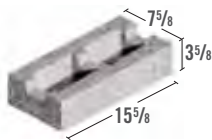

64 8" x 6" x 16" DOUBLE END*

65 8" x 6" x 16" DOUBLE END BREAKER*

66 8" x 6" x 16" SASH & END*

67 8" x 6" x 16" DOUBLE SASH BREAKER*

67a 8" x 6" x 16" DOUBLE END*

8" x 6" x 16"
203 x 152 x 406
UNIT WEIGHT: 25

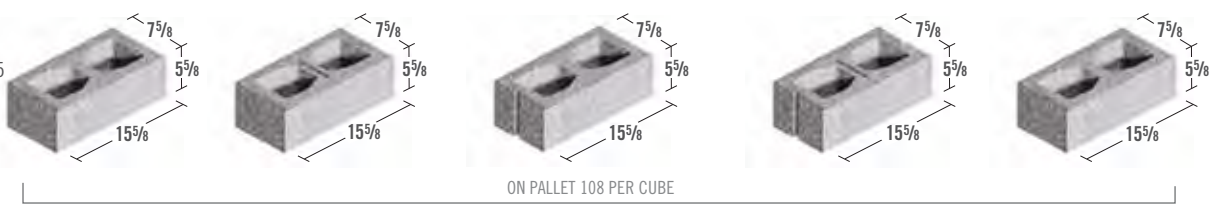

* Architectural cubed CMU's only

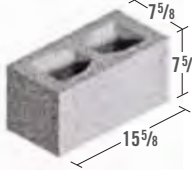
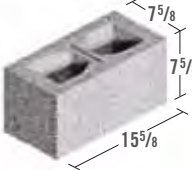
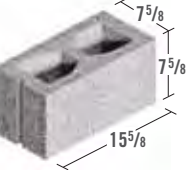
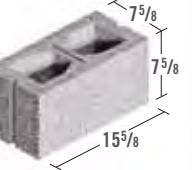

68a	8" x 8" x 16" DOUBLE END*	68b	8" x 8" x 16" DOUBLE END BREAKER*	68c	8" x 8" x 16" SASH & END*	68d	8" x 8" x 16" DOUBLE SASH BREAKER*	68e	8" x 8" x 16" DOUBLE END*
8" x 8" x 16" 203 x 203 x 406 UNIT WEIGHT: 36									
ON PALLET 90 PER CUBE									

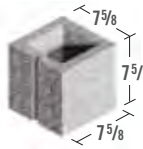
69	8" x 8" x 8" SASH & END
8" x 8" x 8" 203 x 203 x 203 UNIT WEIGHT: 21 ON PALLET 144 PER CUBE	
	

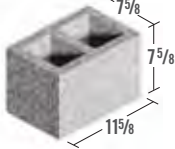
70	8" x 8" x 12" DOUBLE END
8" x 8" x 12" 203 x 203 x 305 UNIT WEIGHT: 29 ON PALLET 120 PER CUBE	
	

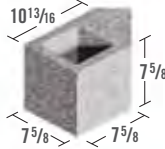
71	8" 45 DEGREE
8" x 8" x 8" x 11" 203 x 203 x 203 x 279 UNIT WEIGHT: 29 ON PALLET 120 PER CUBE	
	

72	8" x 8" x 16" STRETCHER
8" x 8" x 16" 203 x 203 x 406 UNIT WEIGHT: 34	
	
STANDARD CUBE 90 PER CUBE	

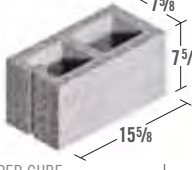
73	8" x 8" x 16" SASH & END
8" x 8" x 16" 203 x 203 x 406 UNIT WEIGHT: 35	
	

74	8" x 8" x 16" 2 HOUR STRETCHER
8" x 8" x 16" 203 x 203 x 406 UNIT WEIGHT: 36	
	
STANDARD CUBE 90 PER CUBE	

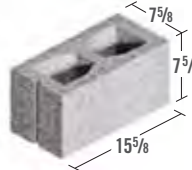
75	8" x 8" x 16" 2 HOUR SASH & END
8" x 8" x 16" 203 x 203 x 406 UNIT WEIGHT: 36	
	
STANDARD CUBE 90 PER CUBE	

76	8" x 8" x 16" 3 HOUR STRETCHER
8" x 8" x 16" 203 x 203 x 406 UNIT WEIGHT: 42	
	
ON PALLET 72 PER CUBE	

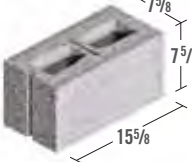
77	8" x 8" x 16" 3 HOUR SASH & END BREAKER
8" x 8" x 16" 203 x 203 x 406 UNIT WEIGHT: 44	
	
ON PALLET 72 PER CUBE	

78	8" x 8" x 16" 4 HOUR STRETCHER
8" x 8" x 16" 203 x 203 x 406 UNIT WEIGHT: 49 NON-STOCK	
	
ON PALLET 72 PER CUBE	

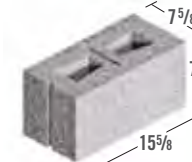
79	8" x 8" x 16" 4 HOUR SASH & END BREAKER
8" x 8" x 16" 203 x 203 x 406 UNIT WEIGHT: 51 NON-STOCK	
	
ON PALLET 72 PER CUBE	

80	8" x 8" x 16" DOUBLE END
8" x 8" x 16" 203 x 203 x 406 UNIT WEIGHT: 36 ON PALLET 90 PER CUBE	
	

*Architectural cubed CMU's only



81 8" x 8" x 16" SASH & END BREAKER

8" x 8" x 16"
203 x 203 x 406
UNIT WEIGHT: 36
ON PALLET
90 PER CUBE

82 8" x 8" x 16" WEEP

8" x 8" x 16"
203 x 203 x 406
UNIT WEIGHT: 33
STANDARD CUBE
90 PER CUBE

83 8" x 8" x 16" TERMITE

8" x 8" x 16"
203 x 203 x 406
UNIT WEIGHT: 43

ON (18) 8" HC

84 8" x 8" x 16" TERMITE SASH & END BREAKER

8" x 8" x 16"
203 x 203 x 406
UNIT WEIGHT: 50

84a 8" x 8" x 16" OPEN CELL TERMITE

8" x 8" x 16"
203 x 203 x 406
UNIT WEIGHT: 38
ON (18) 8" HC
72 PER CUBE

85 8" x 8" x 16" U SOLID BOTTOM BOND BEAM

8" x 8" x 16"
203 x 203 x 406
UNIT WEIGHT: 45
ON PALLET
90 PER CUBE

86 8" x 8" x 16" OPEN BOTTOM BOND BEAM 2 SLOT

8" x 8" x 16"
203 x 203 x 406
UNIT WEIGHT: 37
ON PALLET
90 PER CUBE

87 8" x 8" x 16" RESTRICTED BOND BEAM

8" x 8" x 16"
203 x 203 x 406
UNIT WEIGHT: 32
ON PALLET
90 PER CUBE

88 8" x 8" x 16" GROUT

8" x 8" x 16"
203 x 203 x 406
UNIT WEIGHT: 34
ON PALLET
90 PER CUBE

88a 8" x 8" x 16" OPEN END REBAR

8" x 8" x 16"
203 x 203 x 406
UNIT WEIGHT: 33
ON PALLET
90 PER CUBE

88b 8" x 8" x 16" DOUBLE OPEN END BOND BEAM

8" x 8" x 16"
203 x 203 x 406
UNIT WEIGHT: 32
ON PALLET
90 PER CUBE

88c 8" x 8" x 16" BEAM INTEL

8" x 8" x 16"
203 x 203 x 406
UNIT WEIGHT: 36
ON PALLET
90 PER CUBE
NON-STOCK

89 8" x 8" x 16" KNOCK-OUT PIPE CHASE

8" x 8" x 16"
203 x 203 x 406
UNIT WEIGHT: 35
ON PALLET
90 PER CUBE

89a 8" x 8" x 24" HOLLOW CORE

8" x 8" x 24"
203 x 203 x 610
UNIT WEIGHT: 51
ON PALLET
60 PER CUBE
NON-STOCK

89b 8" x 8" x 20" CORNER/STRETCHER

8" x 8" x 20"
203 x 203 x 508
UNIT WEIGHT: 48
ON PALLET
60 PER CUBE
NON-STOCK

89c 8" x 8" x 12" 1/2 SASH/STRETCHER

8" x 8" x 12"
203 x 203 x 305
UNIT WEIGHT: 28
40 PER CUBE
NON-STOCK

89d 8" x 8" x 24" HOLLOW CORE SASH/STRETCHER

8" x 8" x 24"
203 x 203 x 610
UNIT WEIGHT: 53
40 PER CUBE
NON-STOCK

ON PALLET 80 PER CUBE



89e 8" x 8" x 12" END/STRETCHER

8" x 8" x 12"
203 x 203 x 305
UNIT WEIGHT: 28
40 PER CUBE
NON-STOCK

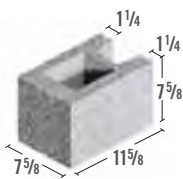

89f 8" x 8" x 24" HOLLOW CORE END/STRETCHER

8" x 8" x 24"
203 x 203 x 610
UNIT WEIGHT: 53
40 PER CUBE
NON-STOCK

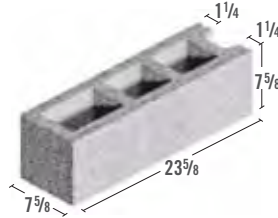

ON PALLET 80 PER CUBE



90 8" x 8" x 16" SOLID BULLNOSE ACROSS FACE

8" x 8" x 16"
203 x 203 x 406
UNIT WEIGHT: 65
ON PALLET
54 PER CUBE
NON-STOCK

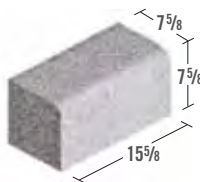

91 8" x 8" x 8" SINGLE BULLNOSE & END

8" x 8" x 8"
203 x 203 x 203
UNIT WEIGHT: 21
ON PALLET
144 PER CUBE

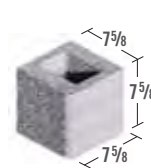

92 8" x 8" x 8" DOUBLE BULLNOSE & END

8" x 8" x 8"
203 x 203 x 203
UNIT WEIGHT: 21
ON PALLET
144 PER CUBE



93 8" x 8" x 16" SINGLE BULLNOSE & END

8" x 8" x 16"
203 x 203 x 406
UNIT WEIGHT: 38
ON PALLET
90 PER CUBE

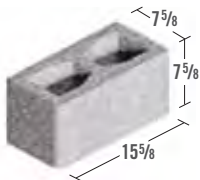

94 8" x 8" x 16" DOUBLE BULLNOSE & END

8" x 8" x 16"
203 x 203 x 406
UNIT WEIGHT: 38
ON PALLET
90 PER CUBE

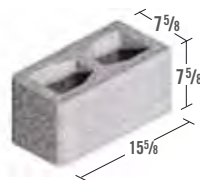

95 8" x 8" x 8" SASH ON SINGLE BULLNOSE & END

8" x 8" x 8"
203 x 203 x 203
UNIT WEIGHT: 21
ON PALLET
144 PER CUBE
NON-STOCK

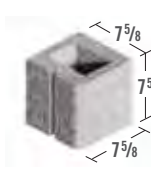

96 8" x 8" x 8" SASH ON DOUBLE BULLNOSE & END

8" x 8" x 8"
203 x 203 x 203
UNIT WEIGHT: 21
ON PALLET
144 PER CUBE
NON-STOCK



97 8" x 8" x 16" SASH ON SINGLE BULLNOSE & STRETCHER BREAKER

8" x 8" x 16"
203 x 203 x 406
UNIT WEIGHT: 38
ON PALLET
90 PER CUBE
NON-STOCK

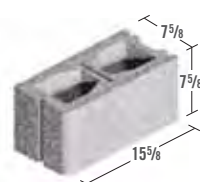

98 8" x 8" x 16" SASH ON DOUBLE BULLNOSE & STRETCHER BREAKER

8" x 8" x 16"
203 x 203 x 406
UNIT WEIGHT: 38
ON PALLET
90 PER CUBE
NON-STOCK

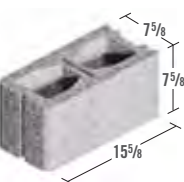

99 8" x 8" x 16" BULLNOSE DOUBLE END (PILASTER)

8" x 8" x 16"
203 x 203 x 406
UNIT WEIGHT: 38
ON PALLET
90 PER CUBE

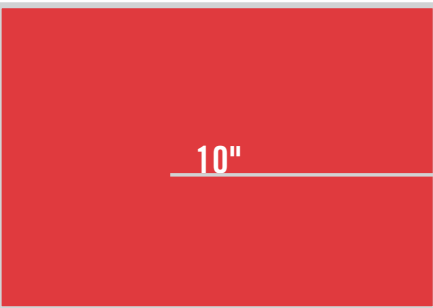
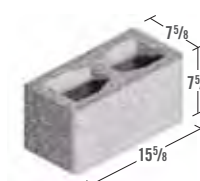

100 10" x 4" x 16" SOLID

10" x 4" x 16"
254 x 102 x 406
UNIT WEIGHT: 41
ON PALLET
90 PER CUBE
NON-STOCK

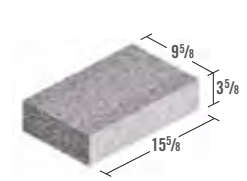



101 10" x 8" x 16" SOLID

10" x 8" x 16"

254 x 203 x 406
UNIT WEIGHT: 84
ON PALLET
45 PER CUBE
NON-STOCK

RATED 4 HOURS

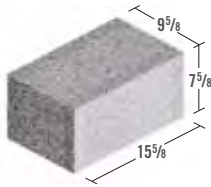

104 10" x 8" x 8" SASH & END

10" x 8" x 8"

254 x 203 x 203
UNIT WEIGHT: 25
ON PALLET
90 PER CUBE

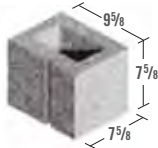

107 10" x 8" x 16" WEEP

10" x 8" x 16"

254 x 203 x 406
UNIT WEIGHT: 46
STANDARD CUBE
72 PER CUBE

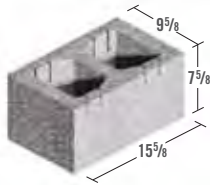

110 10" x 8" x 16" RETURN CORNER

10" x 8" x 16"

254 x 203 x 406
UNIT WEIGHT: 43
ON PALLET
72 PER CUBE



112 10" x 8" x 8" SINGLE BULLNOSE & END

10" x 8" x 8"

254 x 203 x 203
UNIT WEIGHT: 25
ON PALLET
90 PER CUBE

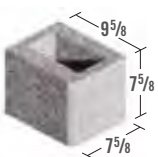

12"

102 10" x 4" x 16" STRETCHER

10" x 4" x 16"

254 x 102 x 406
UNIT WEIGHT: 23
NON-STOCK

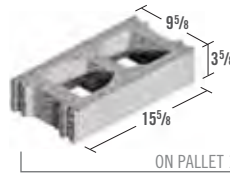

ON PALLET 120 PER CUBE

103 10" x 4" x 16" SASH & END BREAKER

10" x 4" x 16"

254 x 102 x 406
UNIT WEIGHT: 23
NON-STOCK

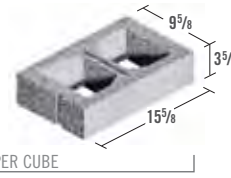

105 10" x 8" x 16" STRETCHER

10" x 8" x 16"

254 x 203 x 406
UNIT WEIGHT: 44

RATED 3 HOURS

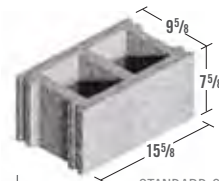

STANDARD CUBE 72 PER CUBE

106 10" x 8" x 16" SASH & END BREAKER

10" x 8" x 16"

254 x 203 x 406
UNIT WEIGHT: 48

RATED 3 HOURS



108 10" x 8" x 16" OPEN BOTTOM BOND BEAM

10" x 8" x 16"

254 x 203 x 406
UNIT WEIGHT: 48
STANDARD CUBE
75 PER CUBE
NON-STOCK

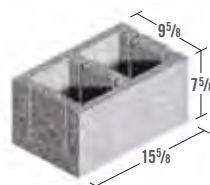

109 10" x 8" x 16" TERMITE OR BOND BEAM

10" x 8" x 16"

254 x 203 x 406
UNIT WEIGHT: 50
ON PALLET
60 PER CUBE

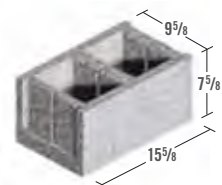

10" BULLNOSE

111 10" x 8" x 16" KNOCK-OUT PIPE CHASE

10" x 8" x 16"

254 x 203 x 406
UNIT WEIGHT: 48
ON PALLET
75 PER CUBE

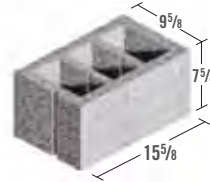

113 10" x 8" x 16" SINGLE BULLNOSE & END

10" x 8" x 16"

254 x 203 x 406
UNIT WEIGHT: 50
ON PALLET
75 PER CUBE

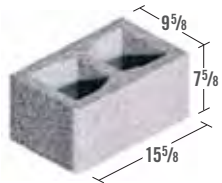

114 10" x 8" x 16" DOUBLE BULLNOSE & END

10" x 8" x 16"

254 x 203 x 406
UNIT WEIGHT: 50
ON PALLET
75 PER CUBE

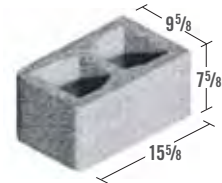

115 12" x 4" x 16" SOLID

12" x 4" x 16"

305 x 102 x 406
UNIT WEIGHT: 48
ON PALLET
72 PER CUBE

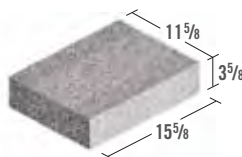

116 12" x 8" x 16" SOLID



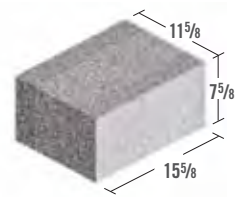

12" x 8" x 16"

305 x 203 x 406
UNIT WEIGHT: 99
ON PALLET
36 PER CUBE

RATED 4 HOURS

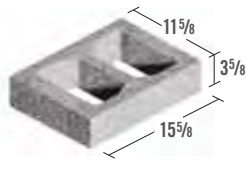
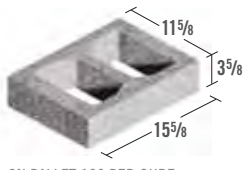
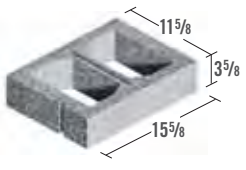
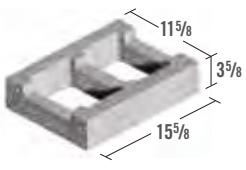
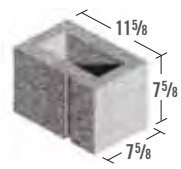
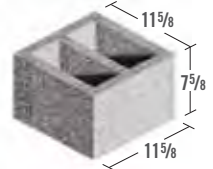
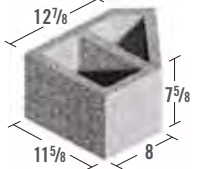

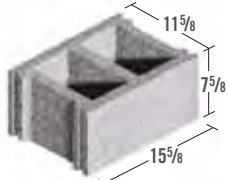

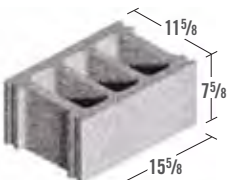
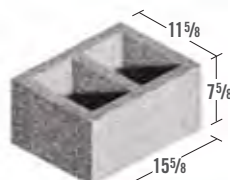
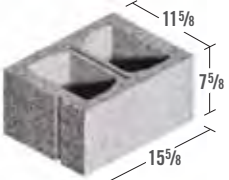
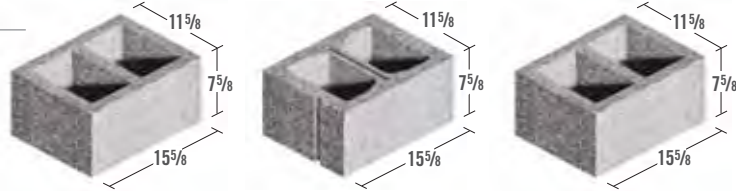
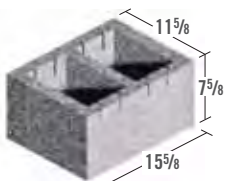
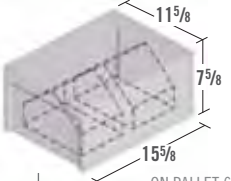
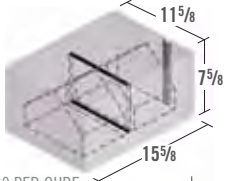
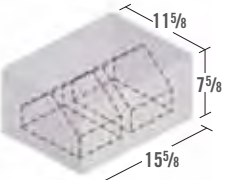
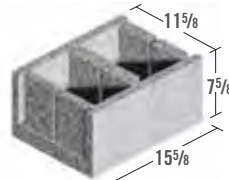
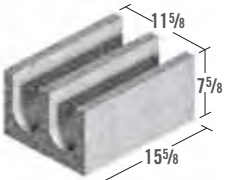
<p>117a 12" x 4" x 16" DOUBLE END</p> <p>12" x 4" x 16" 305 x 102 x 406 UNIT WEIGHT: 23</p>  <p>ON PALLET 120 PER CUBE</p>	<p>117a 12" x 4" x 16" DOUBLE END</p> 	<p>118 12" x 4" x 16" SASH & END BREAKER</p> 	<p>118a 12" x 4" x 16" RESTRICTED BOND BEAM</p> <p>12" x 4" x 16" 305 x 102 x 406 UNIT WEIGHT: 24 ON PALLET 120 PER CUBE</p> 
<p>119 12" x 8" x 8" SASH & END</p> <p>12" x 8" x 8" 305 x 203 x 203 UNIT WEIGHT: 29 ON PALLET 120 PER CUBE</p> 	<p>120 12" x 8" x 12" DOUBLE END</p> <p>12" x 8" x 12" 305 x 203 x 305 UNIT WEIGHT: 41 ON PALLET 80 PER CUBE</p> 	<p>121 12" 45 DEGREE</p> <p>12" x 8" x 8" x 13" 305 x 203 x 203 x 330 UNIT WEIGHT: 42 ON PALLET 60 PER CUBE</p> 	
<p>122 12" x 8" x 16" STRETCHER</p> <p>12" x 8" x 16" 305 x 203 x 406 UNIT WEIGHT: 51 STANDARD CUBE OR ON PALLET 66 PER CUBE  RATED 3 HOURS</p> 	<p>123 12" x 8" x 16" STRETCHER (THREE CORE)</p> <p>12" x 8" x 16" 305 x 203 x 406 UNIT WEIGHT: 53 ON PALLET 60 PER CUBE NON-STOCK  RATED 4 HOURS</p> 	<p>124 12" x 8" x 16" DOUBLE END</p> <p>12" x 8" x 16" 305 x 203 x 406 UNIT WEIGHT: 47 STANDARD CUBE 60 PER CUBE</p> 	
<p>125 12" x 8" x 16" SASH & END BREAKER</p> <p>12" x 8" x 16" 305 x 203 x 406 UNIT WEIGHT: 55 ON PALLET 60 PER CUBE</p> 	<p>125a 12" x 8" x 16" DOUBLE END* 125b 12" x 8" x 16" SASH & END BREAKER* 125c 12" x 8" x 16" DOUBLE END*</p> <p>12" x 8" x 16" 305 x 203 x 406 UNIT WEIGHT: 55</p>  <p>ON PALLET 60 PER CUBE</p>		
<p>126 12" x 8" x 16" WEEP</p> <p>12" x 8" x 16" 305 x 203 x 406 UNIT WEIGHT: 47 STANDARD CUBE 72 PER CUBE</p> 	<p>127 12" x 8" x 16" TERMITE</p> <p>12" x 8" x 16" 305 x 203 x 406 UNIT WEIGHT: 64</p> 	<p>128 12" x 8" x 16" TERMITE SASH & END BREAKER</p> <p>12" x 8" x 16" 305 x 203 x 406 UNIT WEIGHT: 66</p> 	
<p>129 12" x 8" x 16" DOUBLE END TERMITE</p> <p>12" x 8" x 16" 305 x 203 x 406 UNIT WEIGHT: 77 ON PALLET 60 PER CUBE</p> 	<p>130 12" x 8" x 16" TERMITE OR BOND BEAM</p> <p>12" x 8" x 16" 305 x 203 x 406 UNIT WEIGHT: 59 ON PALLET 60 PER CUBE</p> 	<p>131 12" x 8" x 16" W BOND BEAM</p> <p>12" x 8" x 16" 305 x 203 x 406 UNIT WEIGHT: 59 ON PALLET 60 PER CUBE</p> 	

*Architectural cubed CMS's only



132 12" x 8" x 16" OPEN BOTTOM BOND BEAM

12" x 8" x 16"
305 x 203 x 406
UNIT WEIGHT: 58
ON PALLET
60 PER CUBE

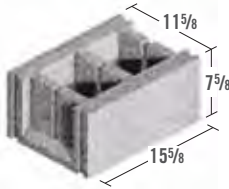

133 12" x 8" x 16" RESTRICTED BOND BEAM

12" x 8" x 16"
305 x 203 x 406
UNIT WEIGHT: 47
ON PALLET
60 PER CUBE

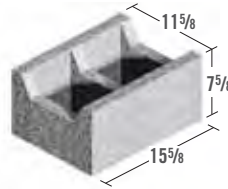

134 12" x 8" x 16" GROUT

12" x 8" x 16"
305 x 203 x 406
UNIT WEIGHT: 39
ON PALLET
60 PER CUBE

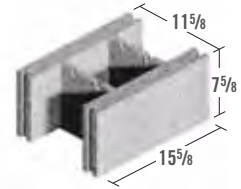

134a 12" x 8" x 16" OPEN END REBAR

12" x 8" x 16"
305 x 203 x 406
UNIT WEIGHT: 46
ON PALLET
60 PER CUBE

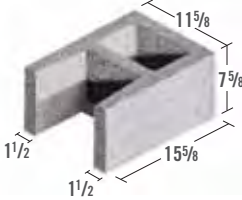

134b 12" x 8" x 16" DOUBLE OPEN END BOND BEAM

12" x 8" x 16"
305 x 203 x 406
UNIT WEIGHT: 46
ON PALLET
60 PER CUBE

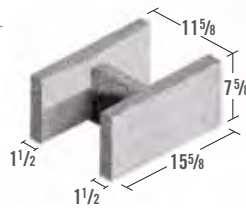

135 12" x 8" x 16" RETURN CORNER

12" x 8" x 16"
305 x 203 x 406
UNIT WEIGHT: 46
ON PALLET
72 PER CUBE

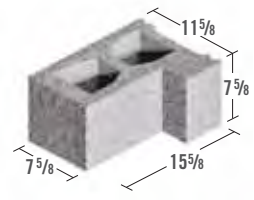

136 12" x 8" x 16" KNOCK-OUT PIPE CHASE

12" x 8" x 16"
305 x 203 x 406
UNIT WEIGHT: 55
ON PALLET
60 PER CUBE

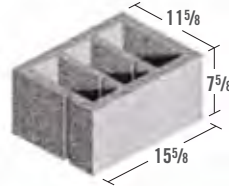

12" BULLNOSE

137 12" x 8" x 8" SINGLE BULLNOSE & END

12" x 8" x 8"
305 x 203 x 203
UNIT WEIGHT: 29
ON PALLET
120 PER CUBE

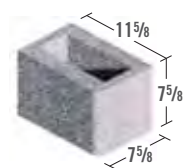

138 12" x 8" x 8" DOUBLE BULLNOSE & END

12" x 8" x 8"
305 x 203 x 203
UNIT WEIGHT: 29
ON PALLET
120 PER CUBE

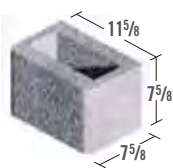

139 12" x 8" x 16" SINGLE BULLNOSE & END

12" x 8" x 16"
305 x 203 x 406
UNIT WEIGHT: 57
ON PALLET
60 PER CUBE

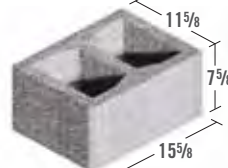

140 12" x 8" x 16" DOUBLE BULLNOSE & END

12" x 8" x 16"
305 x 203 x 406
UNIT WEIGHT: 57
ON PALLET
60 PER CUBE



14"

141 14" x 8" x 16" STRETCHER

14" x 8" x 16"
356 x 203 x 406
UNIT WEIGHT: 55
54 PER CUBE

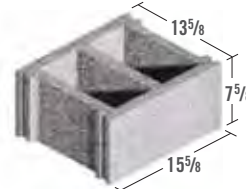

RATED 4 HOURS

141a 14" x 8" x 16" Termite Sash & End

14" x 8" x 16"
356 x 203 x 406
UNIT WEIGHT: 72
45 PER CUBE
Non Stock

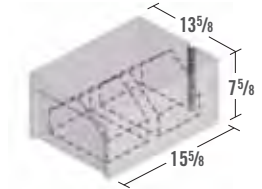

142 14" x 8" x 8" SASH & END

14" x 8" x 8"
356 x 203 x 203
UNIT WEIGHT: 33

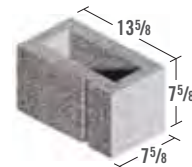

143 14" x 8" x 16" SASH & END

14" x 8" x 16"
356 x 203 x 406
UNIT WEIGHT: 58

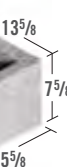

RATED 4 HOURS

ON PALLET 30 OF EACH SHAPE PER CUBE



143a

14" x 8" x 8" SASH ON SINGLE
BULLNOSE & END

14" x 8" x 8"
356 x 203 x 203
UNIT WEIGHT: 33

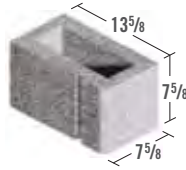

ON PALLET 30 OF EACH SHAPE PER CUBE

143b

14" x 8" x 16" SASH ON SINGLE
BULLNOSE END

14" x 8" x 16"
356 x 203 x 406
UNIT WEIGHT: 53

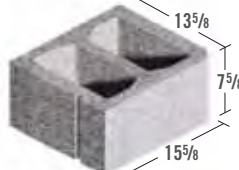

RATED 4 HOURS

16"

144

16" x 8" x 16" STRETCHER

16" x 8" x 16"
406 x 203 x 406
UNIT WEIGHT: 57

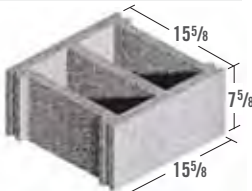

ON PALLET 45 PER CUBE

RATED 4 HOURS

145

16" x 8" x 16" SASH & END

16" x 8" x 16"
406 x 203 x 406
UNIT WEIGHT: 63

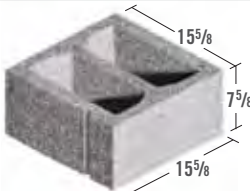

RATED 4 HOURS

145a

16" x 8" x 8" SASH & END

16" x 8" x 8"
406 x 203 x 406
UNIT WEIGHT: 65
90 PER CUBE

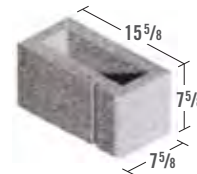

RATED 4 HOURS

SPLIT FACE 4"

146

4" x 3" x 8" SOLID SPLIT FACE
CONCRETE BRICK

4" x 3" x 8"
102 x 57 x 203
UNIT WEIGHT: 4
ON PALLET
525 PER CUBE
NON-STOCK

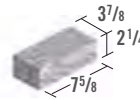

147

4" x 3" x 8" SOLID CORNER & END SPLIT FACE
CONCRETE BRICK

4" x 3" x 8"
102 x 57 x 203
UNIT WEIGHT: 4
ON PALLET
525 PER CUBE
NON-STOCK

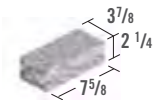

148

4" x 2" x 16" SOLID SPLIT FACE

4" x 2" x 16"
102 x 51 x 406
UNIT WEIGHT: 7
ON PALLET
504 PER CUBE
NON-STOCK

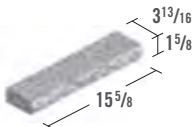

149

4" x 3" x 16" SOLID SPLIT FACE

4" x 3" x 16"
102 x 76 x 406
UNIT WEIGHT: 12
ON PALLET
288 PER CUBE
NON-STOCK

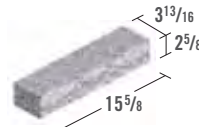

150

4" x 4" x 12" SOLID CORNER & END SPLIT FACE

4" x 4" x 12"
102 x 102 x 305
UNIT WEIGHT: 12
ON PALLET
216 PER CUBE
NON-STOCK

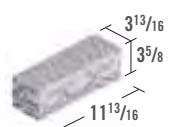

151

4" x 4" x 16" SOLID SPLIT FACE FROGGED

4" x 4" x 16"
102 x 102 x 406
UNIT WEIGHT: 17
ON PALLET
216 PER CUBE
NON-STOCK

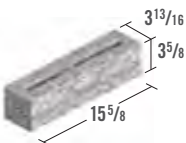

152

4" x 8" x 12" SOLID CORNER & END SPLIT FACE

4" x 8" x 12"
102 x 203 x 305
UNIT WEIGHT: 24
ON PALLET
144 PER CUBE
NON-STOCK



153

4" x 8" x 16" SOLID SPLIT FACE FROGGED

4" x 8" x 16"
102 x 203 x 406
UNIT WEIGHT: 34
ON PALLET
108 PER CUBE
NON-STOCK

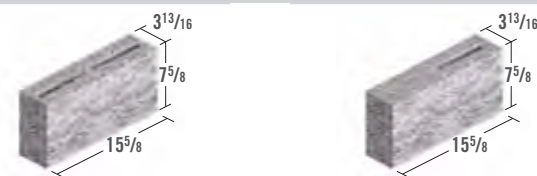

EVERY 3RD HAS 1 FROG TO SPLIT CORNERS IN THE FIELD



SPLIT FACE 6"

156 6" x 8" x 16" SOLID SPLIT FACE

6" x 8" x 16"
152 x 203 x 406
UNIT WEIGHT: 53
ON PALLET
72 PER CUBE
NON-STOCK

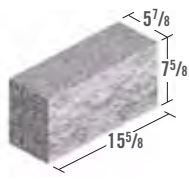

157 6" x 8" x 14" SOLID CORNER & END SPLIT FACE

6" x 8" x 14"
152 x 203 x 356
UNIT WEIGHT: 48
ON PALLET
72 PER CUBE
NON-STOCK

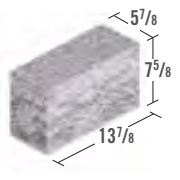

158 6" x 8" x 16" DOUBLE END SPLIT FACE

159 6" x 8" x 16" DOUBLE END BREAKER SPLIT FACE

159a 6" x 8" x 16" SASH & END SPLIT FACE

159b 6" x 8" x 16" DOUBLE SASH BREAKER

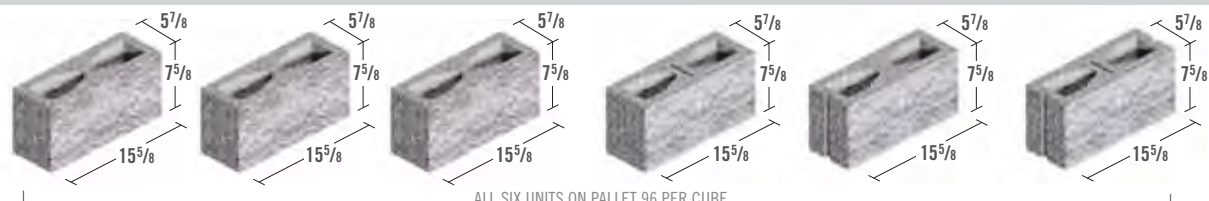

6" x 8" x 16"
152 x 203 x 406
UNIT WEIGHT: 37
ON PALLET
NON-STOCK

SPLIT FACE 8"

160 8" x 4" x 16" SOLID SPLIT FACE

8" x 4" x 16"
203 x 102 x 406
UNIT WEIGHT: 34
ON PALLET
108 PER CUBE
NON-STOCK

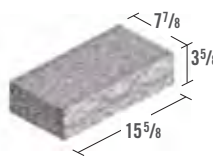

161a 8" x 4" x 16" DOUBLE END SPLIT FACE

162b 8" x 4" x 16" SASH & END SPLIT FACE

162c 8" x 4" x 16" DOUBLE SASH BREAKER SPLIT FACE

162d 8" x 4" x 16" DOUBLE END BREAKER SPLIT FACE

8" x 4" x 16"
203 x 102 x 406
UNIT WEIGHT: 19
NON-STOCK

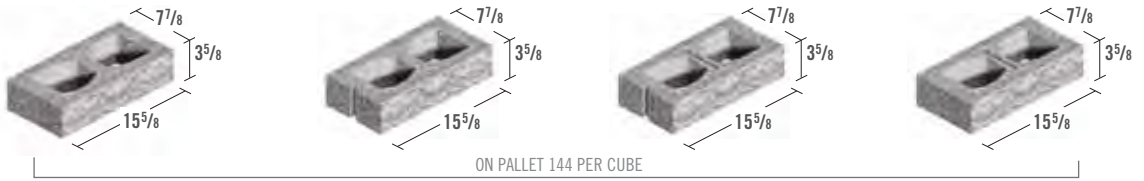

163 8" x 4" x 16" CORNER & END SPLIT FACE

164 8" x 8" x 8" SASH & END SPLIT FACE

8" x 4" x 16"
203 x 102 x 406
UNIT WEIGHT: 19
ON PALLET
120 PER CUBE
NON-STOCK

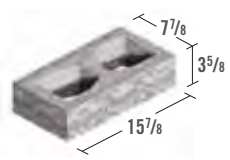

8" x 8" x 8"
203 x 203 x 203
UNIT WEIGHT: 22
ON PALLET
144 PER CUBE

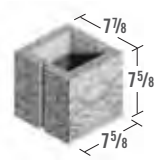

167a 8" x 8" x 16" DOUBLE END SPLIT FACE

167b 8" x 8" x 16" SASH & END SPLIT FACE

167c 8" x 8" x 16" DOUBLE SASH BREAKER SPLIT FACE

167d 8" x 8" x 16" DOUBLE END BREAKER SPLIT FACE

8" x 8" x 16"
203 x 203 x 406
UNIT WEIGHT: 42

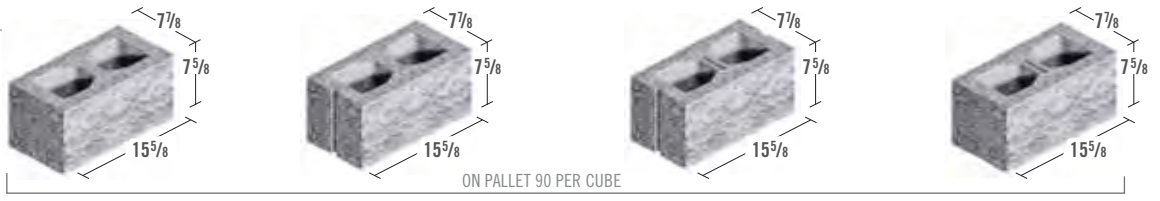



169 8" x 8" x 16" CORNER & END SPLIT FACE

8" x 8" x 16"
203 x 203 x 406
UNIT WEIGHT: 45
ON PALLET
90 PER CUBE

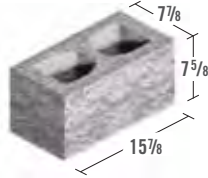

170 8" x 8" x 16" RESTRICTED BOND BEAM OPEN BOTTOM SPLIT FACE

8" x 8" x 16"
203 x 203 x 406
UNIT WEIGHT: 43
ON PALLET
90 PER CUBE
NON-STOCK

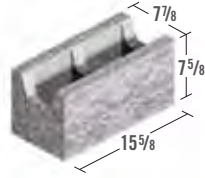

170a 8" x 8" x 16" U BOND BEAM SPLIT FACE

8" x 8" x 16"
203 x 203 x 406
UNIT WEIGHT: 45
ON PALLET
90 PER CUBE
NON-STOCK

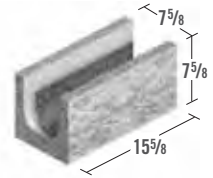

173 8" x 8" x 16" TERMITE OR BOND BEAM SPLIT FACE

8" x 8" x 16"
203 x 203 x 406
UNIT WEIGHT: 63
ON PALLET
72 PER CUBE
NON-STOCK

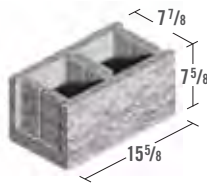

174 8" x 8" x 16" TERMITE SPLIT FACE

8" x 8" x 16"
203 x 203 x 406
UNIT WEIGHT: 54

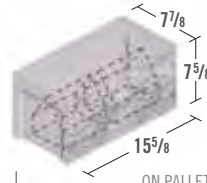

175 8" x 8" x 16" TERMITE SASH & END BREAKER SPLIT FACE

8" x 8" x 16"
203 x 203 x 406
UNIT WEIGHT: 56
NON-STOCK

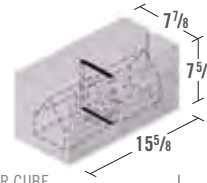

175a 8" x 8" x 16" 45 DEGREE HC SPLIT FACE

8" x 8" x 16"
203 x 203 x 406
UNIT WEIGHT: 53
ON PALLET
40 PER CUBE
NON-STOCK

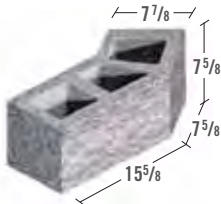

175b 8" x 8" x 16" 45 DEGREE HC SINGLE SCORE SPLIT FACE

8" x 8" x 16"
203 x 203 x 406
UNIT WEIGHT: 53
ON PALLET
40 PER CUBE
NON-STOCK

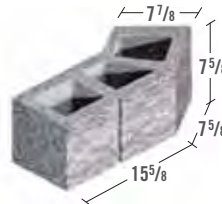

SPLIT FACE 10"

176 10" x 4" x 16" STRETCHER SPLIT FACE

10" x 4" x 16"
254 x 102 x 406
UNIT WEIGHT: 26
NON-STOCK

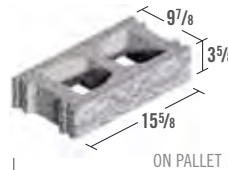

177 10" x 4" x 16" SASH & END BREAKER SPLIT FACE

10" x 4" x 16"
254 x 102 x 406
UNIT WEIGHT: 26
NON-STOCK

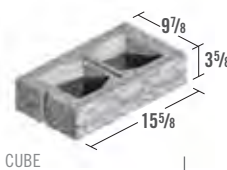

178 10" x 8" x 16" STRETCHER SPLIT FACE

10" x 8" x 16"
254 x 203 x 406
UNIT WEIGHT: 54
NON-STOCK

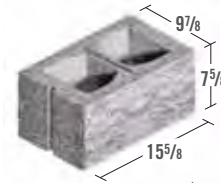
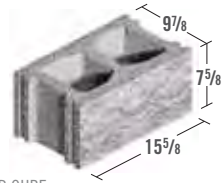
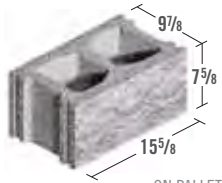
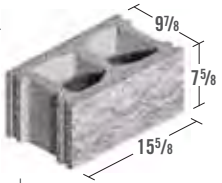

10" x 8" x 16"
254 x 203 x 406
UNIT WEIGHT: 56
NON-STOCK

ON PALLET 60 PER CUBE

180 10" x 8" x 16" TERMITE OR BOND BEAM SPLIT FACE

10" x 8" x 16"
254 x 203 x 406
UNIT WEIGHT: 60
ON PALLET
60 PER CUBE
NON-STOCK

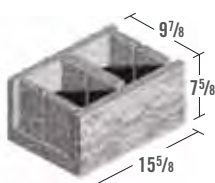

181 10" x 8" x 16" OPEN BOTTOM BOND BEAM SPLIT FACE

10" x 8" x 16"
254 x 203 x 406
UNIT WEIGHT: 53
ON PALLET
72 PER CUBE
NON-STOCK

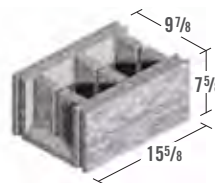



SPLIT FACE 12"

182 12" x 4" x 16" SOLID SPLIT FACE

12" x 4" x 16"
305 x 102 x 406
UNIT WEIGHT: 51
ON PALLET
60 PER CUBE
NON-STOCK

183 12" x 4" x 16" DOUBLE END SPLIT FACE

12" x 4" x 16"
305 x 102 x 406
UNIT WEIGHT: 29
NON-STOCK

ON PALLET 120 PER CUBE

184 12" x 4" x 16" SASH & END BREAKER SPLIT FACE

12" x 4" x 16"
305 x 102 x 406
UNIT WEIGHT: 30
NON-STOCK

185 12" x 8" x 8" SASH & END SPLIT FACE

12" x 8" x 8"
305 x 203 x 203
UNIT WEIGHT: 31
ON PALLET
120 PER CUBE
NON-STOCK

186 12" x 8" x 16" STRETCHER SPLIT FACE

12" x 8" x 16"
305 x 203 x 406
UNIT WEIGHT: 58

ON PALLET 60 PER CUBE

187 12" x 8" x 16" SASH & END BREAKER SPLIT FACE

12" x 8" x 16"
305 x 203 x 406
UNIT WEIGHT: 60
NON-STOCK

188 12" x 8" x 16" TERMITE OR BOND BEAM SPLIT FACE

12" x 8" x 16"
305 x 203 x 406
UNIT WEIGHT: 63
ON PALLET
60 PER CUBE
NON-STOCK

188a 12" x 8" x 16" W BOND BEAM SPLIT FACE

12" x 8" x 16"
305 x 203 x 406
UNIT WEIGHT: 63
ON PALLET
60 PER CUBE
NON-STOCK

188b 12" x 8" x 16" REST. BOND BEAM SPLIT FACE

12" x 8" x 16"
305 x 203 x 406
UNIT WEIGHT: 63
ON PALLET
60 PER CUBE
NON-STOCK

SCORED SPLIT FACE

189 4" x 8" x 12" SOLID CORNER & END SINGLE SCORE SPLIT FACE

4" x 8" x 12"
102 x 203 x 305
UNIT WEIGHT: 25
ON PALLET
168 PER CUBE
NON-STOCK

190 4" x 8" x 16" SOLID SINGLE SCORE SPLIT FACE FROGGED

4" x 8" x 16"
102 x 203 x 406
UNIT WEIGHT: 34
ON PALLET
108 PER CUBE
NON-STOCK

191 8" x 4" x 16" DOUBLE END SINGLE SCORE SPLIT FACE

8" x 4" x 16"
203 x 102 x 406
UNIT WEIGHT: 19
NON-STOCK

ON PALLET 144 PER CUBE

192 8" x 4" x 16" SASH & END BREAKER SINGLE SCORE SPLIT FACE

8" x 4" x 16"
203 x 102 x 406
UNIT WEIGHT: 20
NON-STOCK

193 8" x 4" x 16" CORNER & END SINGLE SCORE SPLIT FACE

8" x 4" x 16"
203 x 102 x 406
UNIT WEIGHT: 19
ON PALLET
120 PER CUBE
NON-STOCK



194a

8" x 8" x 16" DOUBLE END SINGLE SCORE SPLIT FACE

8" x 8" x 16"
203 x 203 x 406
UNIT WEIGHT: 42
NON-STOCK

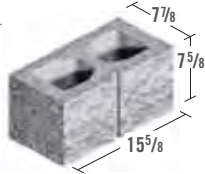

194b

8" x 8" x 16" SASH & END SINGLE SCORE SPLIT FACE

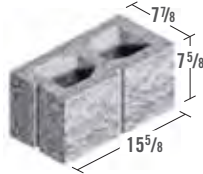

194c

8" x 8" x 16" DOUBLE SASH SINGLE SCORE BREAKER SPLIT FACE

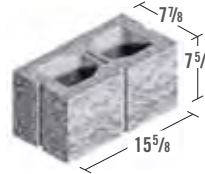

194d

8" x 8" x 16" DOUBLE END BREAKER SINGLE SCORE SPLIT FACE

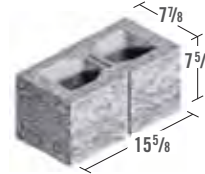

ON PALLET 90 PER CUBE

196

8" x 8" x 16" CORNER & END SINGLE SCORE SPLIT FACE

8" x 8" x 16"
203 x 203 x 406
UNIT WEIGHT: 45
ON PALLET
90 PER CUBE
NON-STOCK

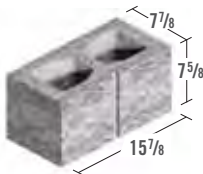

197

12" x 4" x 16" DOUBLE END SINGLE SCORE SPLIT FACE

12" x 4" x 16"
305 x 102 x 406
UNIT WEIGHT: 29
NON-STOCK



198

12" x 4" x 16" SASH & END BREAKER SINGLE SCORE SPLIT FACE

12" x 4" x 16"
305 x 102 x 406
UNIT WEIGHT: 30
NON-STOCK

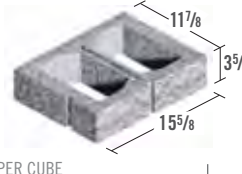

ON PALLET 120 PER CUBE

199

12" x 8" x 16" STRETCHER SINGLE SCORE SPLIT FACE

12" x 8" x 16"
305 x 203 x 406
UNIT WEIGHT: 58
NON-STOCK

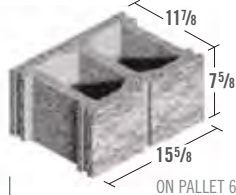

200

12" x 8" x 16" SASH & END BREAKER SINGLE SCORE SPLIT FACE

12" x 8" x 16"
305 x 203 x 406
UNIT WEIGHT: 60
NON-STOCK

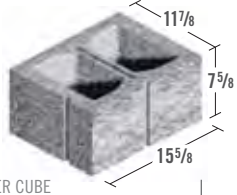

ON PALLET 60 PER CUBE

CASTLE ROCK™

201

4" x 8" x 12" SOLID CORNER CASTLE ROCK

4" x 8" x 12"
102 x 203 x 305
UNIT WEIGHT: 23
ON PALLET
168 PER CUBE
NON-STOCK

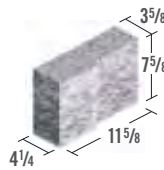

202

4" x 8" x 16" SOLID CASTLE ROCK

4" x 8" x 16"
102 x 203 x 406
UNIT WEIGHT: 34
ON PALLET
108 PER CUBE
NON-STOCK

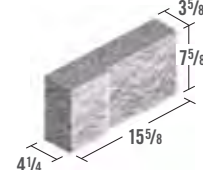

203

8" x 8" x 16" STRETCHER CASTLE ROCK

8" x 8" x 16"
203 x 203 x 406
UNIT WEIGHT: 42
NON-STOCK

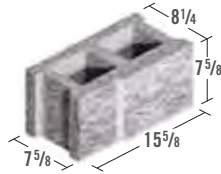

204

8" x 8" x 16" SASH & END BREAKER CASTLE ROCK

8" x 8" x 16"
203 x 203 x 406
UNIT WEIGHT: 43
NON-STOCK

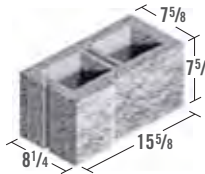

ON PALLET 90 PER CUBE

205

12" x 8" x 16" STRETCHER CASTLE ROCK

12" x 8" x 16"
305 x 203 x 406
UNIT WEIGHT: 58
NON-STOCK

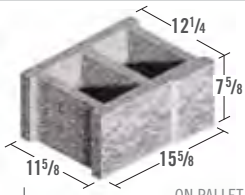

206

12" x 8" x 16" SASH & END BREAKER CASTLE ROCK

12" x 8" x 16"
305 x 203 x 406
UNIT WEIGHT: 59
NON-STOCK

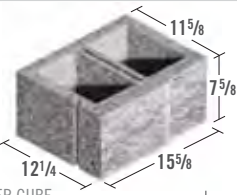

ON PALLET 60 PER CUBE



SHADOW STONE™

209 8" x 8" x 16" STRETCHER SHADOW STONE

8" x 8" x 16"
203 x 203 x 406
UNIT WEIGHT: 43
NON-STOCK

ON PALLET 90 PER CUBE

211 12" x 8" x 16" STRETCHER SHADOW STONE

12" x 8" x 16"
304 x 203 x 406
UNIT WEIGHT: 60
NON-STOCK

ON PALLET 60 PER CUBE

3 FLUTE SPLIT FACE

214 8" x 8" x 16" STRETCHER 3 FLUTE SPLIT FACE

8" x 8" x 16"
203 x 203 x 406
UNIT WEIGHT: 43
NON-STOCK

ON PALLET 60 PER CUBE

217 12" x 8" x 16" STRETCHER 3 FLUTE SPLIT FACE

12" x 8" x 16"
305 x 203 x 406
UNIT WEIGHT: 58
NON-STOCK

ON PALLET 54 PER CUBE

207 4" x 8" x 12" SOLID CORNER SHADOW STONE

4" x 8" x 12"
102 x 203 x 305
UNIT WEIGHT: 23
ON PALLET
168 PER CUBE
NON-STOCK

210 8" x 8" x 16" SASH & END BREAKER SHADOW STONE

8" x 8" x 16"
203 x 203 x 406
UNIT WEIGHT: 43
NON-STOCK

212 12" x 8" x 16" SASH & END BREAKER SHADOW STONE

12" x 8" x 16"
304 x 203 x 406
UNIT WEIGHT: 60
NON-STOCK

213 4" x 8" x 16" SOLID DOUBLE END 3 FLUTE SPLIT FACE

4" x 8" x 16"
102 x 203 x 406
UNIT WEIGHT: 29
ON PALLET
144 PER CUBE
NON-STOCK

215 8" x 8" x 16" SASH & END BREAKER 3 FLUTE SPLIT FACE

8" x 8" x 16"
203 x 203 x 406
UNIT WEIGHT: 44
NON-STOCK

218 12" x 8" x 16" SASH & END BREAKER 3 FLUTE SPLIT FACE

12" x 8" x 16"
305 x 203 x 406
UNIT WEIGHT: 59
NON-STOCK

208 4" x 8" x 16" SOLID SHADOW STONE

4" x 8" x 16"
102 x 203 x 406
UNIT WEIGHT: 34
ON PALLET
108 PER CUBE
NON-STOCK

216 8" x 8" x 16" 45 DEGREE CORNER & END 3 FLUTE SPLIT FACE

8" x 8" x 16"
203 x 203 x 406
UNIT WEIGHT: 44
ON PALLET
60 PER CUBE
NON-STOCK



DEEP 4 FLUTE SPLIT FACE

219 4" x 8" x 12" SOLID CORNER & END DEEP
4 FLUTE SPLIT FACE

4" x 8" x 12"
102 x 203 x 305
UNIT WEIGHT: 24
ON PALLET
96 PER CUBE
NON-STOCK

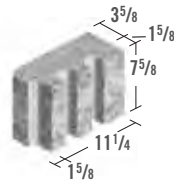

220 4" x 8" x 16" SOLID DOUBLE END DEEP
4 FLUTE SPLIT FACE

4" x 8" x 16"
102 x 203 x 406
UNIT WEIGHT: 30
ON PALLET
108 PER CUBE
NON-STOCK

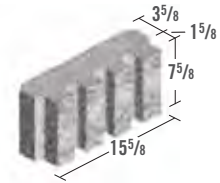

221 8" x 8" x 16" STRETCHER DEEP
4 FLUTE SPLIT FACE

8" x 8" x 16"
203 x 203 x 406
UNIT WEIGHT: 55
NON-STOCK

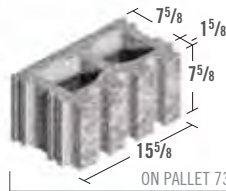

222 8" x 8" x 16" SASH & END BREAKER DEEP
4 FLUTE SPLIT FACE

8" x 8" x 16"
203 x 203 x 406
UNIT WEIGHT: 56
NON-STOCK

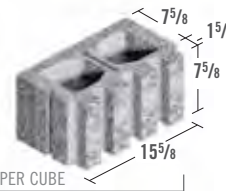

223 10" x 8" x 16" STRETCHER DEEP
4 FLUTE SPLIT FACE

10" x 8" x 16"
254 x 203 x 406
UNIT WEIGHT: 55
NON-STOCK

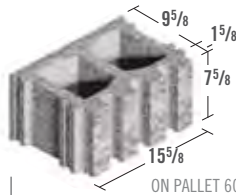

224 10" x 8" x 16" SASH & END BREAKER DEEP
4 FLUTE SPLIT FACE

10" x 8" x 16"
254 x 203 x 406
UNIT WEIGHT: 56
NON-STOCK

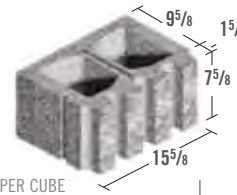

225 12" x 8" x 16" STRETCHER DEEP
4 FLUTE SPLIT FACE

12" x 8" x 16"
305 x 203 x 406
UNIT WEIGHT: 62
ON PALLET
55 PER CUBE
NON-STOCK

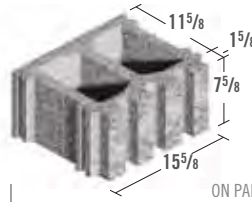

SPECIAL NOTE: WHEN YOU PURCHASE 225 YOU MUST ALSO PURCHASE 221 IN EQUAL AMOUNTS BECAUSE WHEN WE MANUFACTURE A 12" DEEP 4 FLUTE, AN 8" DEEP 4 FLUTE IS MADE IN CONJUNCTION

WIDE 4 FLUTE SPLIT FACE

226 4" x 8" x 16" SOLID DOUBLE END WIDE
4 FLUTE SPLIT FACE

4" x 8" x 16"
102 x 203 x 406
UNIT WEIGHT: 30
ON PALLET
144 PER CUBE
NON-STOCK

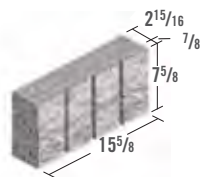

227 4" x 8" x 16" SOLID 45 DEGREE CORNER &
END WIDE 4 FLUTE SPLIT FACE

4" x 8" x 16"
102 x 203 x 406
UNIT WEIGHT: 26
ON PALLET
144 PER CUBE
NON-STOCK

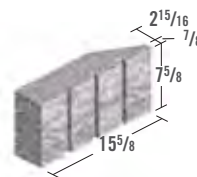

228 8" x 8" x 16" 45 DEGREE CORNER &
WIDE 4 FLUTE SPLIT FACE

8" x 8" x 16"
203 x 203 x 406
UNIT WEIGHT: 45
ON PALLET
75 PER CUBE
NON-STOCK

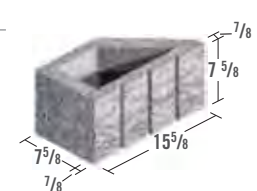

229 8" x 8" x 16" STRETCHER WIDE 4 FLUTE
SPLIT FACE

8" x 8" x 16"
203 x 203 x 406
UNIT WEIGHT: 43
NON-STOCK

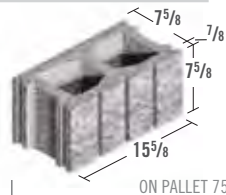

230 8" x 8" x 16" SASH & END BREAKER WIDE
4 FLUTE SPLIT FACE

8" x 8" x 16"
203 x 203 x 406
UNIT WEIGHT: 44
NON-STOCK

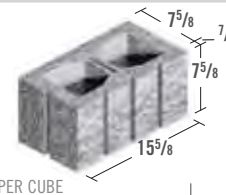

ON PALLET 75 PER CUBE



231 12" x 8" x 16" STRETCHER WIDE
4 FLUTE SPLIT FACE

12" x 8" x 16"
305 x 203 x 406
UNIT WEIGHT: 57
NON-STOCK

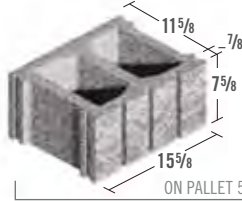

232 12" x 8" x 16" SASH & END BREAKER WIDE
4 FLUTE SPLIT FACE

12" x 8" x 16"
305 x 203 x 406
UNIT WEIGHT: 58
NON-STOCK

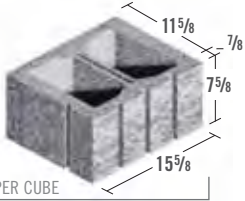

6 FLUTE SPLIT FACE

233 4" x 8" x 16" SOLID DOUBLE END 6 FLUTE
SPLIT FACE

4" x 8" x 16"
102 x 203 x 406
UNIT WEIGHT: 29
ON PALLET
144 PER CUBE
NON-STOCK

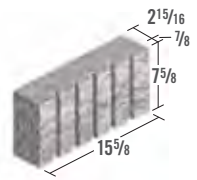

234 4" x 8" x 16" SOLID 45 DEGREE CORNER &
END 6 FLUTE SPLIT FACE

4" x 8" x 16"
102 x 203 x 406
UNIT WEIGHT: 26
ON PALLET
144 PER CUBE
NON-STOCK

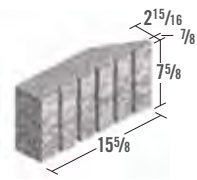

235 8" x 8" x 16" 45 DEGREE CORNER & END
6 FLUTE SPLIT FACE

8" x 8" x 16"
203 x 203 x 406
UNIT WEIGHT: 43
ON PALLET
75 PER CUBE
NON-STOCK

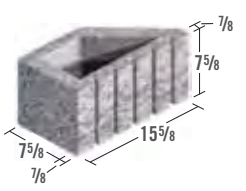

236 8" x 8" x 16" STRETCHER 6 FLUTE
SPLIT FACE

8" x 8" x 16"
203 x 203 x 406
UNIT WEIGHT: 43
NON-STOCK

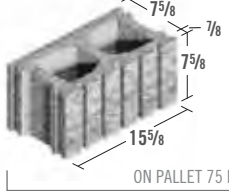

237 8" x 8" x 16" SASH & END BREAKER
6 FLUTE SPLIT FACE

8" x 8" x 16"
203 x 203 x 406
UNIT WEIGHT: 44
NON-STOCK

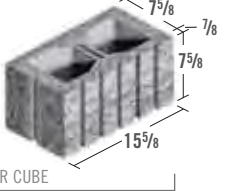

238 12" x 8" x 16" STRETCHER 6 FLUTE SPLIT FACE

12" x 8" x 16"
305 x 203 x 406
UNIT WEIGHT: 58
NON-STOCK

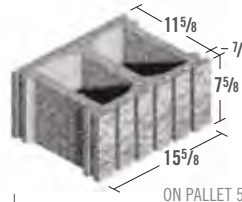

239 12" x 8" x 16" SASH & END BREAKER
6 FLUTE SPLIT FACE

12" x 8" x 16"
305 x 203 x 406
UNIT WEIGHT: 59
NON-STOCK

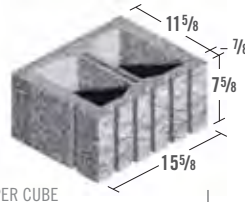

8 FLUTE SPLIT FACE

240 4" x 8" x 16" SOLID DOUBLE END 8 FLUTE
SPLIT FACE

4" x 8" x 16"
102 x 203 x 406
UNIT WEIGHT: 30
ON PALLET
144 PER CUBE
NON-STOCK

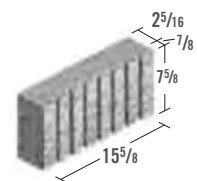

241 4" x 8" x 16" SOLID 45 DEGREE CORNER &
END 8 FLUTE SPLIT FACE

4" x 8" x 16"
102 x 203 x 406
UNIT WEIGHT: 26
ON PALLET
144 PER CUBE
NON-STOCK

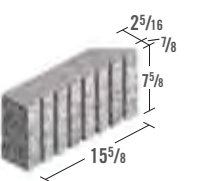

242 8" x 8" x 16" 45 DEGREE CORNER & END
8 FLUTE SPLIT FACE

8" x 8" x 16"
203 x 203 x 406
UNIT WEIGHT: 40
ON PALLET
75 PER CUBE
NON-STOCK

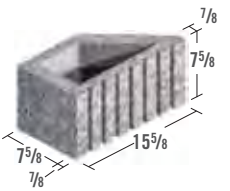

243 8" x 8" x 16" STRETCHER 8 FLUTE SPLIT FACE

8" x 8" x 16"
203 x 203 x 406
UNIT WEIGHT: 43
NON-STOCK

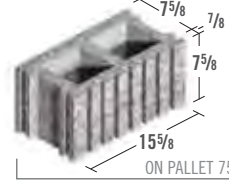

244 8" x 8" x 16" SASH & END BREAKER
8 FLUTE SPLIT FACE

8" x 8" x 16"
203 x 203 x 406
UNIT WEIGHT: 44
NON-STOCK

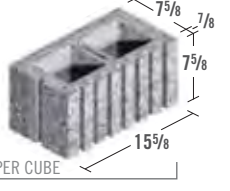

245

12" x 8" x 16"

305 x 203 x 406
UNIT WEIGHT: 61
NON-STOCK

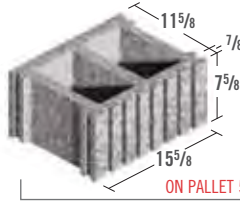

ON PALLET 54 PER CUBE

246

12" x 8" x 16" SASH & END BREAKER
8 FLUTE SPLIT FACE

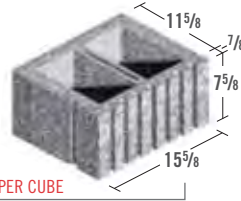

12" x 8" x 16"

305 x 203 x 406
UNIT WEIGHT: 62
NON-STOCK

**STRI-FACE &
SCORED STRI-FACE**

247

4" x 8" x 16" DOUBLE END STRI-FACE

4" x 8" x 16"

102 x 203 x 406
UNIT WEIGHT: 26
ON PALLET
144 PER CUBE
NON-STOCK

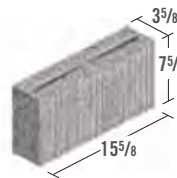

248

4" x 8" x 16" CORNER & END STRI-FACE

4" x 8" x 16"

102 x 203 x 406
UNIT WEIGHT: 26
ON PALLET
144 PER CUBE
NON-STOCK

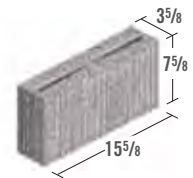

249

8" x 8" x 16" STRETCHER STRI-FACE

8" x 8" x 16"

203 x 203 x 406
UNIT WEIGHT: 36
NON-STOCK

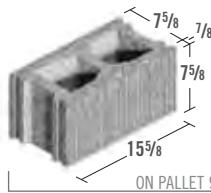

ON PALLET 90 PER CUBE

250

8" x 8" x 16" SASH & END STRI-FACE

8" x 8" x 16"

203 x 203 x 406
UNIT WEIGHT: 36
NON-STOCK

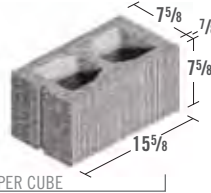

251

8" x 8" x 16" CORNER & END STRI-FACE

8" x 8" x 16"

203 x 203 x 406
UNIT WEIGHT: 36
90 PER CUBE
NON-STOCK

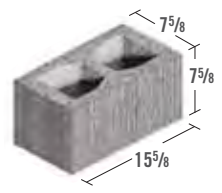

252

12" x 8" x 16" STRETCHER STRI-FACE

12" x 8" x 16"

305 x 203 x 406
UNIT WEIGHT: 52
NON-STOCK

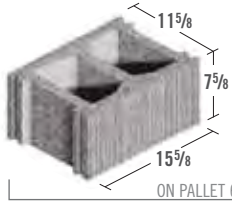

ON PALLET 60 PER CUBE

253

12" x 8" x 16" SASH & END BREAKER
STRI-FACE

12" x 8" x 16"

305 x 203 x 406
UNIT WEIGHT: 53
NON-STOCK

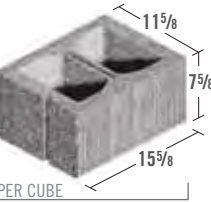

254

4" x 8" x 16" DOUBLE END TRIPLE SCORE
STRI-FACE

4" x 8" x 16"

102 x 203 x 406
UNIT WEIGHT: 31
ON PALLET
108 PER CUBE
NON-STOCK

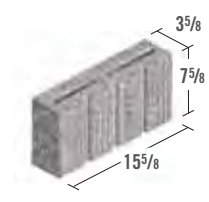

255

8" x 8" x 16" STRETCHER TRIPLE
SCORE STRI-FACE

8" x 8" x 16"

203 x 203 x 406
UNIT WEIGHT: 36
NON-STOCK

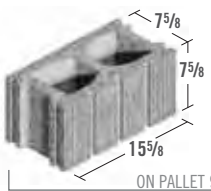

ON PALLET 90 PER CUBE

256

8" x 8" x 16" SASH & END TRIPLE
SCORE STRI-FACE

8" x 8" x 16"

203 x 203 x 406
UNIT WEIGHT: 36
NON-STOCK

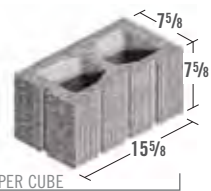

257

8" x 8" x 16" CORNER & SASH
TRIPLE SCORE STRI-FACE

8" x 8" x 16"

203 x 203 x 406
UNIT WEIGHT: 36
ON PALLET
90 PER CUBE
NON-STOCK

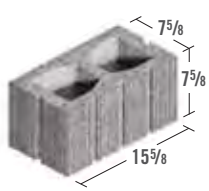

258

12" x 8" x 16" STRETCHER TRIPLE
SCORE STRI-FACE

12" x 8" x 16"

305 x 203 x 406
UNIT WEIGHT: 52
NON-STOCK

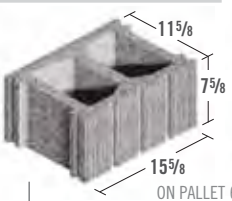

ON PALLET 60 PER CUBE

259

12" x 8" x 16" SASH & END BREAKER
TRIPLE SCORE STRI-FACE

12" x 8" x 16"

305 x 203 x 406
UNIT WEIGHT: 52
NON-STOCK

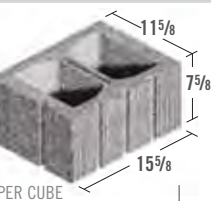



SOLID CHAMFERED SILLS

261 4" x 8" x 16" SOLID CHAMFERED SILL

4" x 8" x 16"
102 x 203 x 406
UNIT WEIGHT: 28
ON PALLET
108 PER CUBE
NON-STOCK

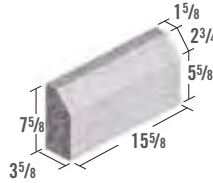

263 6" x 8" x 16" SOLID CHAMFERED SILL

6" x 8" x 16"
152 x 203 x 406
UNIT WEIGHT: 47
ON PALLET
72 PER CUBE
NON-STOCK

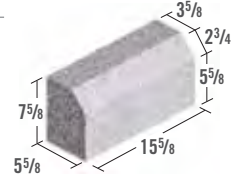

264 8" x 8" x 16" SOLID CHAMFERED SILL

8" x 8" x 16"
203 x 203 x 406
UNIT WEIGHT: 64
ON PALLET
54 PER CUBE
NON-STOCK

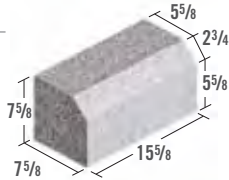

266 4" x 8" x 16" SOLID CHAMFERED SILL SPLIT FACE

4" x 8" x 16"
102 x 203 x 406
UNIT WEIGHT: 29
ON PALLET
108 PER CUBE
NON-STOCK



268 6" x 8" x 16" SOLID CHAMFERED SILL SPLIT FACE

6" x 8" x 16"
152 x 203 x 406
UNIT WEIGHT: 48
ON PALLET
72 PER CUBE
NON-STOCK

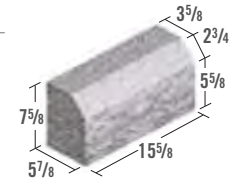

269 8" x 8" x 16" SOLID CHAMFERED SILL SPLIT FACE

8" x 8" x 16"
203 x 203 x 406
UNIT WEIGHT: 66
ON PALLET
54 PER CUBE
NON-STOCK

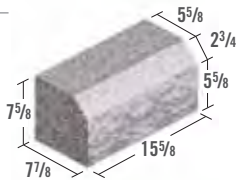

COLOSSALBLOK™

270 4" x 12" x 16" SOLID

4" x 12" x 16"
102 x 305 x 406
UNIT WEIGHT: 50
ON PALLET
72 PER CUBE
NON-STOCK

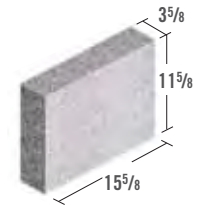

272 4" x 8" x 24" SOLID

4" x 8" x 24"
102 x 203 x 610
UNIT WEIGHT: 50
ON PALLET
72 PER CUBE
NON-STOCK

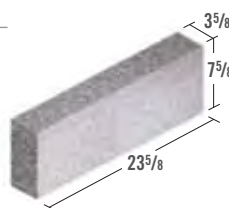

273 4" x 12" x 24" SOLID

4" x 12" x 24"
102 x 305 x 610
UNIT WEIGHT: 80
ON PALLET
48 PER CUBE
NON-STOCK

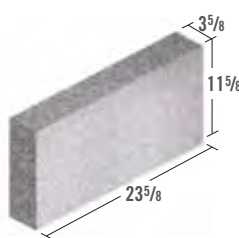

274 6" x 12" x 36" WATER TABLE

6" x 12" x 36"
152 x 305 x 914
UNIT WEIGHT: 180
ON PALLET
16 PER CUBE
NON-STOCK

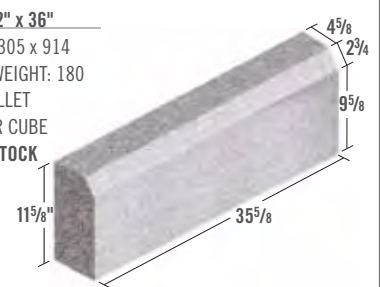

275 4" x 12" x 16" SOLID SPLIT FACE

4" x 12" x 16"
102 x 305 x 406
UNIT WEIGHT: 53
ON PALLET
72 PER CUBE
NON-STOCK

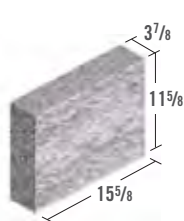

277 4" x 8" x 24" SOLID SPLIT FACE

4" x 8" x 24"
102 x 203 x 610
UNIT WEIGHT: 53
ON PALLET
72 PER CUBE
NON-STOCK

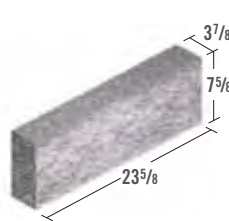

278 4" x 12" x 24" SOLID SPLIT FACE

4" x 12" x 24"
102 x 305 x 610
UNIT WEIGHT: 83
ON PALLET
48 PER CUBE
NON-STOCK

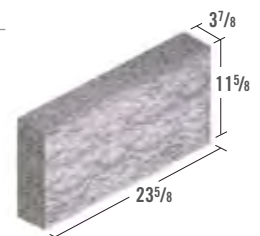



SOUNDBLOX®

282 8" x 8" x 16" TYPE RSC (8") SOUNDBLOX

8" x 8" x 16"
203 x 203 x 406
UNIT WEIGHT: 43
ON PALLET
90 PER CUBE
NON-STOCK

285 12" x 8" x 16" TYPE RSC (12") SOUNDBLOX

12" x 8" x 16"
305 x 203 x 406
UNIT WEIGHT: 59
ON PALLET
60 PER CUBE
NON-STOCK

288 8" x 8" x 16" TYPE RSC/RF (8") SOUNDBLOX

8" x 8" x 16"
203 x 203 x 406
UNIT WEIGHT: 43
ON PALLET
90 PER CUBE
NON-STOCK

STRAIGHT THROUGH CAVITIES

291 12" x 8" x 16" TYPE RSC/RF4 (12") SOUNDBLOX

12" x 8" x 16"
305 x 203 x 406
UNIT WEIGHT: 59
ON PALLET
60 PER CUBE
NON-STOCK

STRAIGHT THROUGH CAVITIES

280 4" x 8" x 16" TYPE RSC (4") SOUNDBLOX

4" x 8" x 16"
102 x 203 x 406
UNIT WEIGHT: 24
ON PALLET
144 PER CUBE
NON-STOCK

283 8" x 8" x 16" TYPE RSC (8") LH SOUNDBLOX

8" x 8" x 16"
203 x 203 x 406
UNIT WEIGHT: 43
ON PALLET
90 PER CUBE
NON-STOCK

286 12" x 8" x 16" TYPE RSC (12") LH SOUNDBLOX

12" x 8" x 16"
305 x 203 x 406
UNIT WEIGHT: 59
ON PALLET
60 PER CUBE
NON-STOCK

289 10" x 8" x 16" TYPE RSC/RF (10") SOUNDBLOX

10" x 8" x 16"
254 x 203 x 406
UNIT WEIGHT: 51
ON PALLET
72 PER CUBE
NON-STOCK

STRAIGHT THROUGH CAVITIES

**AZAR MORTARLESS
DRY-STACK®**

281 6" x 8" x 16" TYPE RSC (6") SOUNDBLOX

6" x 8" x 16"
152 x 203 x 406
UNIT WEIGHT: 33
ON PALLET
108 PER CUBE
NON-STOCK

284 8" x 8" x 16" TYPE RSC (8") RH SOUNDBLOX

8" x 8" x 16"
203 x 203 x 406
UNIT WEIGHT: 43
ON PALLET
90 PER CUBE
NON-STOCK

287 12" x 8" x 16" TYPE RSC (12") RH SOUNDBLOX

12" x 8" x 16"
305 x 203 x 406
UNIT WEIGHT: 59
ON PALLET
60 PER CUBE
NON-STOCK

290 12" x 8" x 16" TYPE RSC/RF (12") SOUNDBLOX

12" x 8" x 16"
305 x 203 x 406
UNIT WEIGHT: 59
ON PALLET
60 PER CUBE
NON-STOCK

STRAIGHT THROUGH CAVITIES

292 8" x 8" x 16" AZAR STRETCHER

8" x 8" x 16"
203 x 203 x 406
UNIT WEIGHT: 42
ON PALLET
90 PER CUBE
NON-STOCK

293 8" x 8" x 16" AZAR LEFT-HAND CORNER

8" x 8" x 16"
203 x 203 x 406
UNIT WEIGHT: 44
ON PALLET
45 PER CUBE
CUBED WITH
RH CORNER

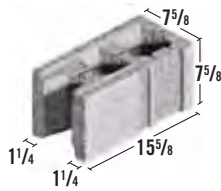

ON PALLET 90 PER CUBE

294 8" x 8" x 16" AZAR RIGHT-HAND CORNER

8" x 8" x 16"
203 x 203 x 406
UNIT WEIGHT: 44
ON PALLET
45 PER CUBE
CUBED WITH
LH CORNER
NON-STOCK

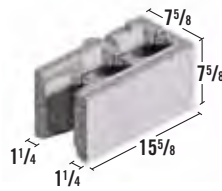

295 8" x 8" x 8" AZAR HALF UNIT

8" x 8" x 8"
203 x 203 x 203
UNIT WEIGHT: 25
ON PALLET
60 PER CUBE
CUBED WITH
FULL END

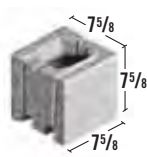

ON PALLET 120 PER CUBE

296 8" x 8" x 16" AZAR FULL SASH

8" x 8" x 16"
203 x 203 x 406
UNIT WEIGHT: 44
ON PALLET
60 PER CUBE
CUBED WITH
1/2 END
NON-STOCK

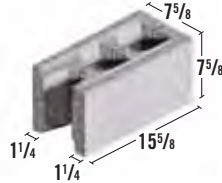

Hi R® ENERGY WALL SYSTEM

297 12" x 4" x 16" Hi R SMOOTH*

12" x 4" x 16"
305 x 102 x 406
UNIT WEIGHT: 22
ON PALLET
120 PER CUBE
NON-STOCK

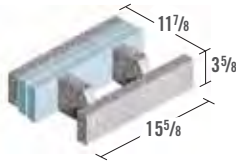

298 12" x 4" x 16" Hi R SPLIT FACE*

12" x 4" x 16"
305 x 102 x 406
UNIT WEIGHT: 23
ON PALLET
120 PER CUBE
NON-STOCK

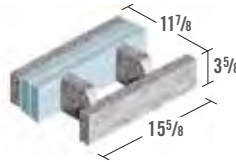

299 12" x 8" x 16" Hi R SMOOTH*

12" x 8" x 16"
305 x 203 x 406
UNIT WEIGHT: 43
ON PALLET
60 PER CUBE
NON-STOCK

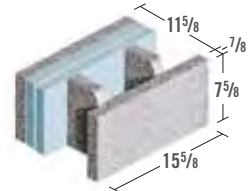

300 12" x 8" x 16" Hi R SPLIT FACE*

12" x 8" x 16"
305 x 102 x 406
UNIT WEIGHT: 44
ON PALLET
60 PER CUBE
NON-STOCK

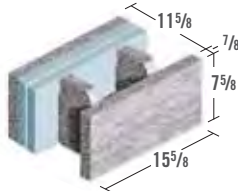

ARTISTRY SERIES

301 4" x 4" x 16" SOLID TUMBLED FROGGED

4" x 4" x 16"
102 x 102 x 406
UNIT WEIGHT: 17
ON PALLET
NON-STOCK

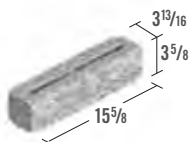

302 4" x 8" x 8" SOLID TUMBLED

4" x 8" x 8"
102 x 203 x 203
UNIT WEIGHT: 17
ON PALLET
NON-STOCK



303 4" x 8" x 16" SOLID TUMBLED FROGGED

4" x 8" x 16"
102 x 203 x 406
UNIT WEIGHT: 34
ON PALLET
NON-STOCK

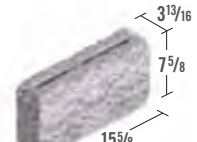

*Go to www.oberfields.com for corner, sash and control joint details.



CORNER DETAILS ▽

<p>A 4" WALL USING 4" x 8" x 12" SOLID CORNER & END SPLIT FACE</p> <p>1st COURSE 2nd COURSE</p>	<p>B 4" WALL USING 4" x 8" x 16" FULL RETURN L CORNER SPLIT FACE</p> <p>1st COURSE 2nd COURSE</p>	<p>C 4" WALL USING 4" x 8" x 12" CORNER & END DEEP 4 FLUTE SPLIT FACE</p> <p>1st COURSE 2nd COURSE</p>
<p>D 4" WALL USING 4" x 8" x 16" 45° CORNER & END 8 FLUTE SPLIT FACE</p> <p>1st COURSE 2nd COURSE</p>	<p>E 6" WALL USING 6" x 8" x 14" DOUBLE END</p> <p>1st COURSE 2nd COURSE</p>	<p>F 8" WALL USING 4" x 8" x 12" SOLID CORNER & END SPLIT FACE</p> <p>1st COURSE 2nd COURSE</p>
<p>G 8" WALL USING 8" x 8" x 16" CORNER & END SPLIT FACE</p> <p>1st COURSE 2nd COURSE</p>	<p>H 8" DOUBLE SIDED SPLIT FACE WALL USING 4" x 8" x 12" SOLID CORNER & END SPLIT FACE</p> <p>1st COURSE 2nd COURSE</p>	<p>I 8" WALL USING 4" x 8" x 12" CORNER & END DEEP 4 FLUTE SPLIT FACE</p> <p>1st COURSE 2nd COURSE</p>
<p>J 8" WALL USING 8" x 8" x 16" 45° CORNER & END 8 FLUTE SPLIT FACE</p> <p>1st COURSE 2nd COURSE</p>	<p>K 10" WALL USING 10" x 8" x 16" RETURN CORNER</p> <p>1st COURSE 2nd COURSE</p>	<p>L 12" WALL USING 4" x 8" x 12" SOLID CORNER SPLIT FACE</p> <p>1st COURSE 2nd COURSE</p>



CORNER DETAILS (CONTINUED) ▾

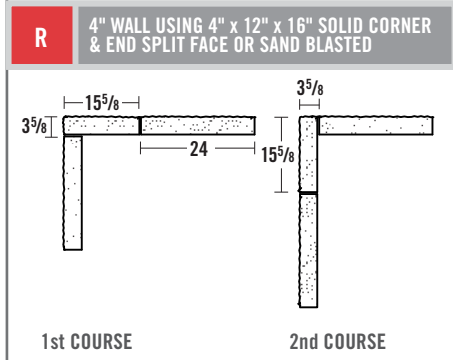
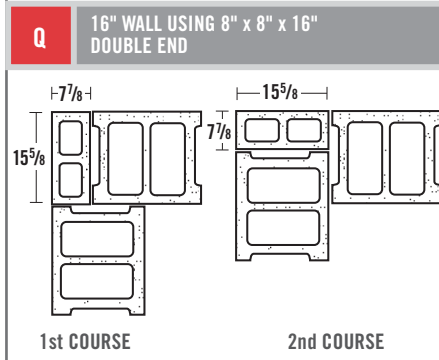
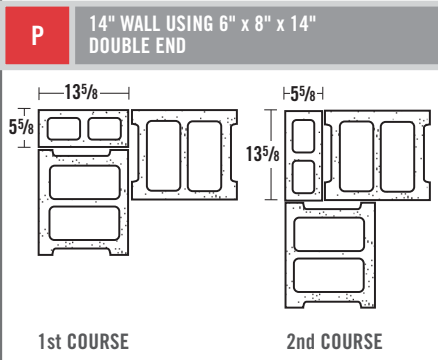
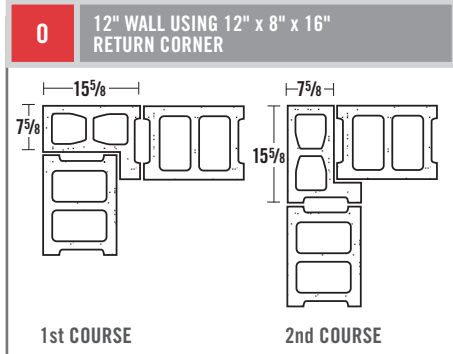
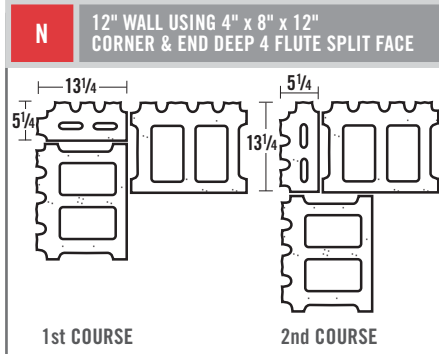
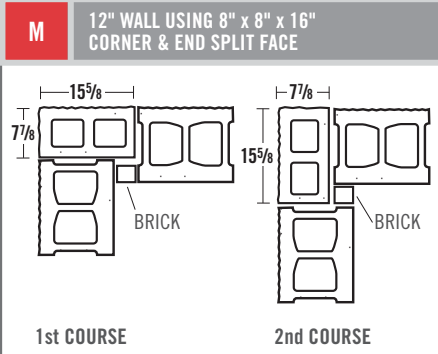

PIER DETAILS ▾

8" UNITS



8" & 12" UNITS

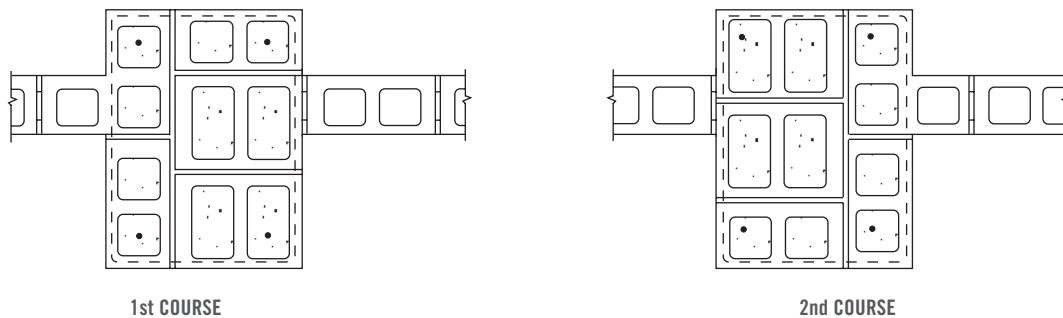



LENGTH OF CONCRETE MASONRY WALLS BY STRETCHERS

NO. OF STRETCHERS	WALL LENGTH
1	1'4"
1.5	2'0"
2	2'8"
2.5	3'4"
3	4'0"
3.5	4'8"
4	5'4"
4.5	6'0"
5	6'8"
5.5	7'4"
6	8'0"
6.5	8'8"
7	9'4"
7.5	10'0"
8	10'8"
8.5	11'4"
9	12'0"
9.5	12'8"
10	13'4"
10.5	14'0"
11	14'8"
11.5	15'4"
12	16'0"
12.5	16'8"
13	17'4"
13.5	18'0"
14	18'8"
14.5	19'4"
15	20'0"
20	26'8"



HEIGHT OF CONCRETE MASONRY WALLS BY COURSES

NO. OF COURSES	WALL HEIGHT					
	3/8" BED JOINT		7/16" BED JOINT		1/2" BED JOINT	
	8" BLOCK	4" BLOCK	8" block	4" block	8" block	4" block
1	8"	4"	8 ¹ / ₁₆ "	4 ¹ / ₁₆ "	8 ¹ / ₈ "	4 ¹ / ₈ "
2	1'4"	8"	1'4 ¹ / ₈ "	8 ¹ / ₈ "	1'4 ¹ / ₄ "	8 ¹ / ₄ "
3	2'0"	1'0"	2' ¹³ / ₁₆ "	1' ¹³ / ₁₆ "	2' ³ / ₈ "	1' ³ / ₈ "
4	2'8"	1'4"	2'8 ¹ / ₄ "	1'4 ¹ / ₄ "	2'8 ¹ / ₂ "	1'4 ¹ / ₂ "
5	3'4"	1'8"	3'4 ⁵ / ₁₆ "	1'8 ⁵ / ₁₆ "	3'4 ⁵ / ₈ "	1'8 ⁵ / ₈ "
6	4'0"	2'0"	4' ³ / ₈ "	2' ³ / ₈ "	4' ³ / ₄ "	2' ³ / ₄ "
7	4'8"	2'4"	4'8 ⁷ / ₁₆ "	2'4 ⁷ / ₁₆ "	4'8 ⁷ / ₈ "	2'4 ⁷ / ₈ "
8	5'4"	2'8"	5'4 ¹ / ₂ "	2'8 ¹ / ₂ "	5'5"	2'9"
9	6'0"	3'0"	6' ⁹ / ₁₆ "	3' ⁹ / ₁₆ "	6'1 ¹ / ₈ "	3'1 ¹ / ₈ "
10	6'8"	3'4"	6'8 ⁵ / ₈ "	3'4 ⁵ / ₈ "	6'9 ¹ / ₄ "	3'5 ¹ / ₄ "
15	10'0"	5'0"	10' ¹⁵ / ₁₆ "	5' ¹⁵ / ₁₆ "	10'1 ⁷ / ₈ "	5'1 ⁷ / ₈ "
20	13'4"	6'8"	13'5 ¹ / ₄ "	6'9 ¹ / ₄ "	13'6 ¹ / ₂ "	6'10 ¹ / ₂ "
25	16'8"	8'4"	16'9 ⁹ / ₁₆ "	8'5 ⁹ / ₁₆ "	16'11 ¹ / ₈ "	8'7 ¹ / ₈ "
30	20'0"	10'0"	20'1 ⁷ / ₈ "	10'1 ⁷ / ₈ "	20'3 ³ / ₄ "	10'3 ³ / ₄ "
35	23'4"	11'8"	23'6 ³ / ₁₆ "	11'10 ³ / ₁₆ "	23'8 ³ / ₈ "	12' ³ / ₈ "
40	26'8"	13'4"	26'10 ¹ / ₂ "	13'6 ¹ / ₂ "	27'1"	13'9"
45	30'0"	15'0"	30'2 ¹³ / ₁₆ "	15'2 ¹³ / ₁₆ "	30'5 ⁵ / ₈ "	15'5 ⁵ / ₈ "
50	33'4"	16'8"	33'7 ¹ / ₈ "	16'11 ¹ / ₈ "	33'10 ¹ / ₄ "	17'2 ¹ / ₄ "

* Based on concrete blocks 15⁵/₈ in. long and half units 7⁵/₈ in. long, with ³/₈ in. thick head joints. Actual lengths of finished walls are ³/₈ in. less than the modular dimensions shown in this table.



ESTIMATING GUIDES ▽ The figures shown below are intended for “rule of thumb” use only

UNIT QUANTITIES

Standard Block (8x8x16)
1.13 block per square foot of wall area

Concrete Brick
7.0 concrete brick per square foot of wall area

Half-High Block (4x4x16 or 8x4x16)
2.26 block per square foot of wall area

APPROXIMATE VOLUME REQUIRED TO FILL CORE VOIDS IN BLOCK

6 x 8 x 16	2 core	0.17 cu.ft./block
6 x 8 x 16	3 core	0.15 cu.ft./block
8 x 8 x 16	2 core	0.25 cu.ft./block
8 x 8 x 16	3 core	0.22 cu.ft./block
10 x 8 x 16	2 core	0.33 cu.ft./block
10 x 8 x 16	3 core	0.29 cu.ft./block
12 x 8 x 16	2 core	0.39 cu.ft./block
12 x 8 x 16	3 core	0.34 cu.ft./block

Example: 5000 - 8" - 2 core H.C. to be filled
5000 x 0.25 = 1250 cu. ft. ÷ 27 cu. ft. per yard
= 46.30 yards

MORTAR QUANTITIES

Per 1000 Units	Masonry Cement Bags	Sand Tons
4" and 6" Regular Block	20	2
8", 10", and 12" Regular Block	25	2½
Concrete Brick	8	1¼

APPROXIMATE QUANTITIES OF CONCRETE REQUIRED TO FILL LINTELS AND BOND BEAMS ▽

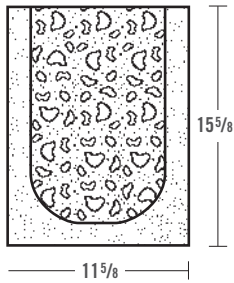

.74 cu.ft. concrete per lin. ft.

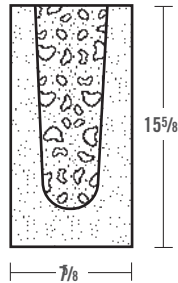

.46 cu.ft. concrete per lin. ft.

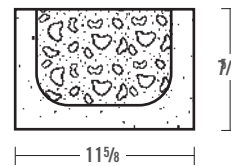

.37 cu.ft. concrete per lin. ft.

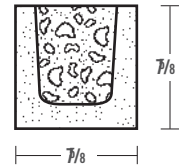

.22 cu.ft. concrete per lin. ft.

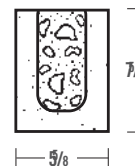

.173 cu.ft. concrete per lin. ft.

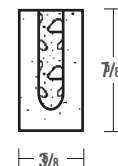

.08 cu.ft. concrete per lin. ft.



DESIGNSTONE AUTO CAD DRAWINGS ▾

C-111

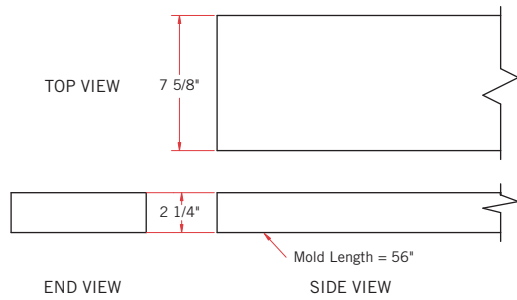

DESCRIPTION:

Coping

DATE:	Sept. 1, 2011	DRAWING NUMBER: C-111
DRAWN BY:	Lew Wood	
SCALE:	3/16"=1"	
NUMBER of MOLDS:	2	

C-1

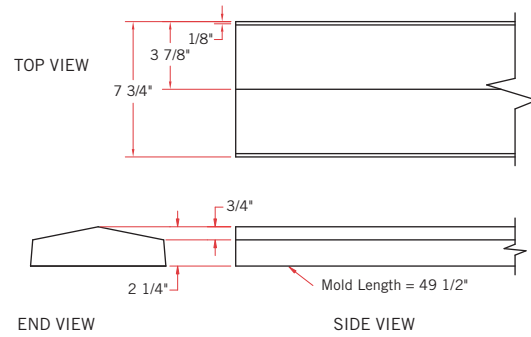

DESCRIPTION:

Coping

DATE:	Sept. 1, 2011	DRAWING NUMBER: C-1
DRAWN BY:	Lew Wood	
SCALE:	3/16"=1"	
NUMBER of MOLDS:	1	

C-12

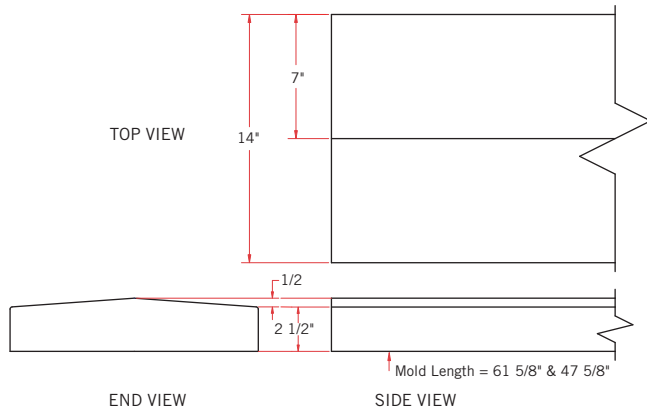

DESCRIPTION:

Coping

DESCRIPTION:		2 special corner molds available.
		3 molds are 47 5/8" in length
		2 molds are 61 5/8" in length
DATE:	Sept. 1, 2011	DRAWING NUMBER: C-12
DRAWN BY:	Lew Wood	
SCALE:	3/16"=1"	
NUMBER of MOLDS:	5	

C-19

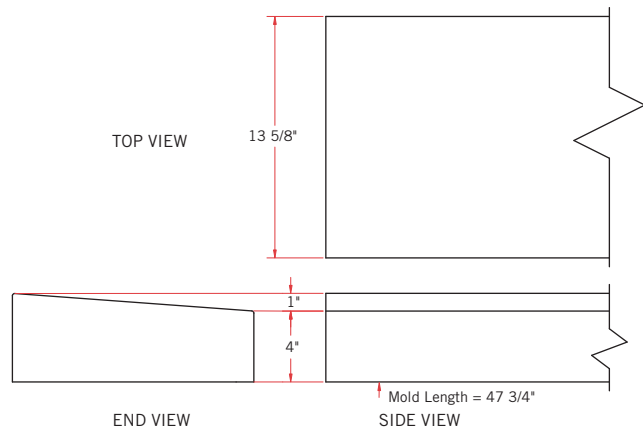

DESCRIPTION:

Sill

DATE:	Sept. 1, 2011	DRAWING NUMBER: C-19
DRAWN BY:	Lew Wood	
SCALE:	3/16"=1"	
NUMBER of MOLDS:	1	

REQUIRED SPECIFICATIONS:

1. Units are available with or without standard drips. Number and location of drip edges must be specified.
2. Unit lengths must be specified for molds that have end gates.
3. Colors other than standard gray are available and must be specified.
4. Finish textures other than standard smooth, dense concrete are available and must be specified.



DESIGNSTONE AUTO CAD DRAWINGS ▾

C-20

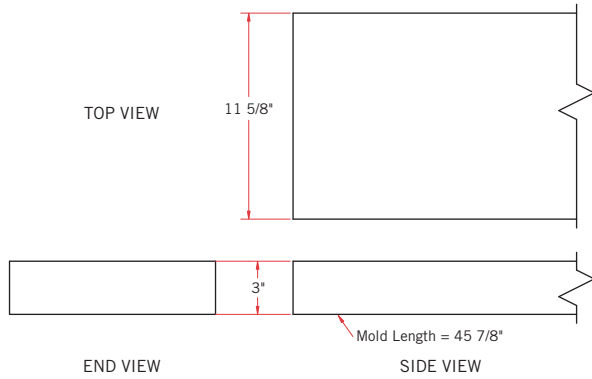

DESCRIPTION: Coping		
DATE:	Sept. 1, 2011	DRAWING NUMBER: C-20
DRAWN BY:	Lew Wood	
SCALE:	3/16"=1"	
NUMBER of MOLDS:	1	

C-3

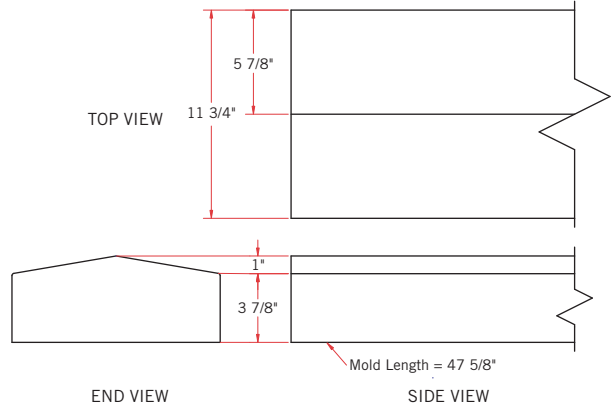

DESCRIPTION: Coping		
DATE:	Sept. 1, 2011	DRAWING NUMBER: C-3
DRAWN BY:	Lew Wood	
SCALE:	3/16"=1"	
NUMBER of MOLDS:	3	

C-37

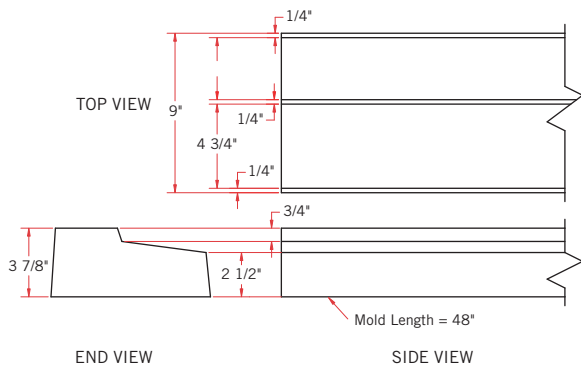

DESCRIPTION: Sill		
DATE:	Sept. 1, 2011	DRAWING NUMBER: C-37
DRAWN BY:	Lew Wood	
SCALE:	3/16"=1"	
NUMBER of MOLDS:	7	

C-406

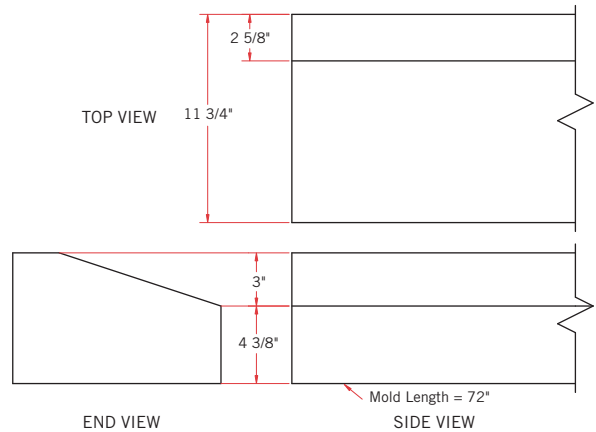

DESCRIPTION: Sill		
DATE:	Sept. 1, 2011	DRAWING NUMBER: C-406
DRAWN BY:	Lew Wood	
SCALE:	3/16"=1"	
NUMBER of MOLDS:	2	

REQUIRED SPECIFICATIONS:

1. Units are available with or without standard drips. Number and location of drip edges must be specified.
2. Unit lengths must be specified for molds that have end gates.
3. Colors other than standard gray are available and must be specified.
4. Finish textures other than standard smooth, dense concrete are available and must be specified.



DESIGNSTONE AUTO CAD DRAWINGS ▾

C-41

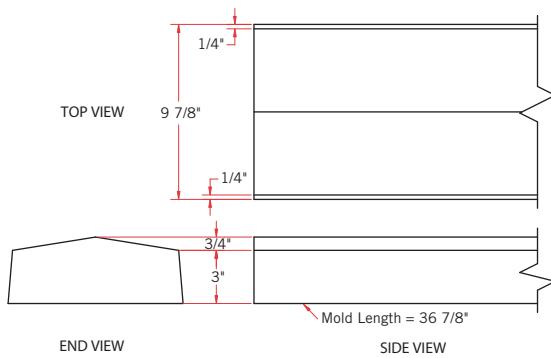

DESCRIPTION: Coping		
DATE:	Sept. 1, 2011	DRAWING NUMBER: C-41
DRAWN BY:	Lew Wood	
SCALE:	3/16"=1"	
NUMBER of MOLDS:	1	

C-44

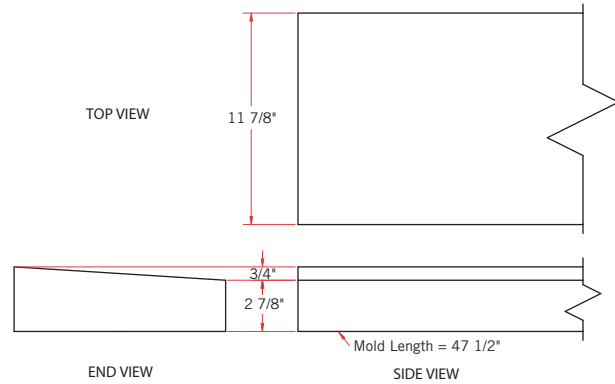

DESCRIPTION: Sill Std. drip available on 1 or both edges.		
DATE:	Sept. 1, 2011	DRAWING NUMBER: C-44
DRAWN BY:	Lew Wood	
SCALE:	3/16"=1"	
NUMBER of MOLDS:	4	

REQUIRED SPECIFICATIONS:

1. Units are available with or without standard drips. Number and location of drip edges must be specified.
2. Unit lengths must be specified for molds that have end gates.
3. Colors other than standard gray are available and must be specified.
4. Finish textures other than standard smooth, dense concrete are available and must be specified.

CLEANING CONCRETE MASONRY ▾ OBERFIELDS LLC. **recommended** procedure for cleaning concrete masonry surfaces.

NEW CONSTRUCTION

In order to reduce the amount of cleaning required at the completion of a building, walls should be cleaned each day. Mortar droppings should be allowed to harden slightly, then scraped off with a trowel or wood scraper. A small piece of broken block is also effective, followed by brushing with a stiff bristle or stainless steel wire brush (never use a steel wire brush).

Good masonry practices will minimize the amount of final cleaning significantly. Turning scaffolding boards at the end of the day and using sand or straw at the base of the wall will eliminate stains that are very difficult to remove later. Another important step is to cover the top of unfinished walls at the end of each day. This will prevent water from entering the cavities and will help prevent efflorescence. The plastic or tarps should drape at least two feet down each side of the wall.

Final cleaning will be easier if it occurs approximately one week after completion of walls (newly constructed walls must set 4 or 5 days to allow the mortar to harden prior to cleaning).

Never use high pressure cleaning! The use of high pressure power washers will most certainly alter the appearance of a concrete masonry wall and could cause unreparable damage to the building. A pressure washer with a maximum of 200 psi and a wide flare nozzle held 12 to 18 inches from the surface will give excellent results on most projects. Pre-wetting walls is a necessary first step. Work in sections from top down for best results.

CHEMICAL CLEANING

If good masonry practices are followed, chemical cleaning will seldom be necessary. If required, consult project specifications or call OBERFIELDS LLC for product recommendations.

Follow mix solutions and directions of manufacturer. Always pre-wet surfaces prior to application of any cleaning solution.

Oil stains, grease, graffiti or efflorescence removal, refer to N.C.M.A. Tek Notes 8.1, 8.2, 8.3, and 8.4. Copies of these teks are available from OBERFIELDS LLC, www.oberfields.com, or The National Concrete Masonry Association.

A Masonry Design Service of OBERFIELDS LLC

Smooth Face Architectural Concrete Masonry

“Smooth Face Architectural Concrete Masonry” is the designation used when a manufacturer produces a regular concrete block in a colored mix design. The only visual difference between Smooth Face Architectural Concrete Masonry and regular block...is the color.

For architects to achieve their design objective, it is important to understand the limitations of Smooth Face Architectural Concrete Masonry. This purpose of this MDS is to provide insight on the production process and field handling which collectively influence the finish and appearance of these block walls.

At the Block Plant

TEXTURE

Smooth Face Architectural Concrete Block is produced using the same molds and production process as a regular block. The texture and aris of Smooth Face Architectural Block are very similar

to a regular concrete block. Smooth Face Architectural Block produced from white aggregate tend to have even rougher edges and irregular texture due to the physical characteristics of most white aggregates.

COLOR CONSISTENCY

Concrete products use synthetic iron oxides to achieve color. The colored iron oxides are batched into the concrete mix where they are bound into the cement paste. The pigmented cement paste then acts as a binding agent for the aggregates in the concrete product.

When concrete block are produced, this pigmented concrete mix is compacted in the mold under high pressure. This pressure forces the cement paste to the surface of the block. When you look at a Smooth Face Architectural Block, the color you see is predominately the cement paste. The concentration of cement paste that is forced to the surface varies block per block causing the overall color of the Smooth Face Block to change.

This is not true with Split Face, Ground Face or Sandblasted units. Split Face

Block are molded together and split apart after they are removed from the kiln. The concentration of cement paste forms on the opposite side of the finished surface. The cement paste on the surface of Sandblasted and Ground Face Block is either blasted or ground off during the manufacturing process. Both Sandblasted and Ground Face rely on the exposed aggregate matrix of the concrete to achieve their appearance.

To illustrate this point, view the Split, Sandblasted or Ground Face of an Architectural Concrete Masonry wall during construction. Next, look at the opposite side of that very same wall. The surface that removes the cement paste and exposes the aggregate matrix (split, sandblasted or ground) will show only a slight range of color. The surface with the cement paste remaining (smooth face) will show a wide noticeable color range.

Concrete block are cured in large kilns in a block plant. The goal of curing is hydration of the cement and is typically accomplished by elevating the temperature and moisture in the kiln. Temperature and



moisture significantly affect the color of cement paste. Because the temperature and moisture vary within the kiln, the color of the cement paste will vary throughout the block in the kiln. Split Face, Ground Face or Sandblasted, whose finished surface do not rely on the surface cement paste are not affected. Smooth Face Block is significantly affected.

Handling At The Jobsite

CHIPPING

ASTM C-90 Standard Specification for "Load Bearing Concrete Masonry Units" recognizes that all concrete block projects experience chipping of the units from delivery and handling at the jobsite. "Minor cracks incidental to the usual method of manufacturing or minor chipping resulting from customary methods of handling in shipment and delivery are not grounds for rejection." The rough texture of Split Face and Sandblasted Block mask minor chips and allow the mason contractor to fill in a minor chip while the mortar joints are tooled. Small chips and rough edges are

very difficult and often not possible to blend into the Smooth Face Block due to its lack of texture.

SCRATCHING

The concentrated colored cement paste on the surface of a Smooth Face Block will scratch during customary methods of handling and delivery. One block rubbing against another removes the cement paste at the point of impact. This scratch appears as a white chalky line which cannot be removed by washing. Split Face are not as vulnerable to scratching as the aggregates of the exposed concrete matrix mask impact marks. Sandblasted Block are not affected as the entire surface has been etched by sand during the Sandblast process.

Suggested Design Considerations For Using Architectural Smooth Face Block

The wide color range and handling blemishes inherent in Smooth Face Architectural Concrete Block Walls can be minimized by limiting this style of block to small areas of the wall at higher

elevations. An example is single course bands of Architectural Smooth Face Block within a field of Split Face.

Often Architectural Smooth Face Block are used for budget reasons after Split Face, Sandblasted or Ground Face Block have been eliminated due to their higher cost. One option is to use regular concrete block and stain the wall afterward. Deep penetrating masonry stains maintain the natural texture of the block and have excellent durability. These colored stains mask jobsite blemishes and blend in the wide range of color visible in regular concrete block walls.

If you have questions on this Masonry Design Service, or are interested in learning more on deep penetrating masonry stains, please contact our office at 614.252.0955.



We think you'll agree-in concrete masonry, you won't find a more solid performer than OBERFIELDS.

OBERFIELDS LLC is a value-centered business rich in tradition, innovation, and excellence, with a strong commitment to its people, customers, and the communities in which it does business.

OBERFIELDS LLC is Ohio's leading manufacturer, marketer, and technical resource for superior quality machine made and precast concrete products. OBERFIELDS also distributes a wide selection of top quality resale building materials merchandise to complement its innovative core product offering.

OBERFIELDS has over 50 years of experience serving the concrete products industry. Its six manufacturing plants, three direct sales and distribution yards, and network of dealers and distributors throughout six states provide residential and commercial

markets with a full range of concrete products and related materials including: standard concrete masonry; DesignBLOK® split-face architectural masonry; SpecBRIK®; DesignSTONE ornamental precast; lintels; interlocking concrete pavers and patio stones; retaining wall systems; sitescape products; and a full line of concrete masonry building materials. You won't find a more complete line or more industry expertise in the entire region when it comes to standard or architectural concrete masonry. We have several Certified Construction Document Technologists on staff to provide full support for our products, including solutions to complex design and construction challenges.

OBERFIELDS serves many primary and secondary customers. Retail customers, do-it-yourselfers, contractors, distributors, government organizations, institutions, retail outlets, builders, architects, engineers, and developers all call on OBERFIELDS for service. Through five decades of service, OBERFIELDS has become Ohio's supplier of choice for contractors, developers and

builders by exceeding the demands of design flexibility, aesthetics, structural integrity, durability, fire resistance, sound reduction and thermal qualities.

Our tagline, Solid Performance in Concrete Products®, represents OBERFIELDS belief that high quality concrete products and superior customer service and support leads to a satisfied customer. OBERFIELDS prides itself on its ability to offer customized products and individually tailored solutions to meet your construction needs. OBERFIELDS technically sound sales, marketing, and customer service teams are prepared to answer questions relating to specifications, product applications, and designs or to take an order.

Call 614-252-0955, 740-369-7644, or 800-845-7644 or visit us on the web at www.oberfields.com

