



ROSETTA®

CHANGE YOUR VIEW

PRE-PLANNED PATIO DESIGNS



OBERFIELDS

WHAT OUTDOOR LIVING
SHOULD BE®

TABLE OF CONTENTS

YOUR LIFE JUST GOT A LITTLE BIT EASIER.

And your work just a got a lot more fun. With this Pre-Planned Patio Design Guide, selling and installing your customer’s dream patio will seem more like completing a life-sized puzzle than work.

With this simple, complete resource at your fingertips, you can bid, sell, and install patio after patio, without spending any extra time estimating and designing.

Oberfields products are easy to install and look more like natural stone than any other man-made product you can find. That makes Oberfields the premier hardscape option for you and your customers.

The patio designs contained in this guide are labeled as “rustic” and “formal” because some of your customers will want a laid back curvy design, and others will want a more formal, sleek design. Both sets include options to cater to various budgets. There’s a patio for everyone—sell on, friend.

These reference materials detail many practical ways to create a beautiful outdoor living space with Oberfields’ line of natural looking wall and patio stones.

This document is intended as a supplement to the Oberfields Tech-Guide, which contains detailed product information for all Oberfields products. Get one from your local Oberfields dealer, or download the Tech-Guide at Oberfields.com.

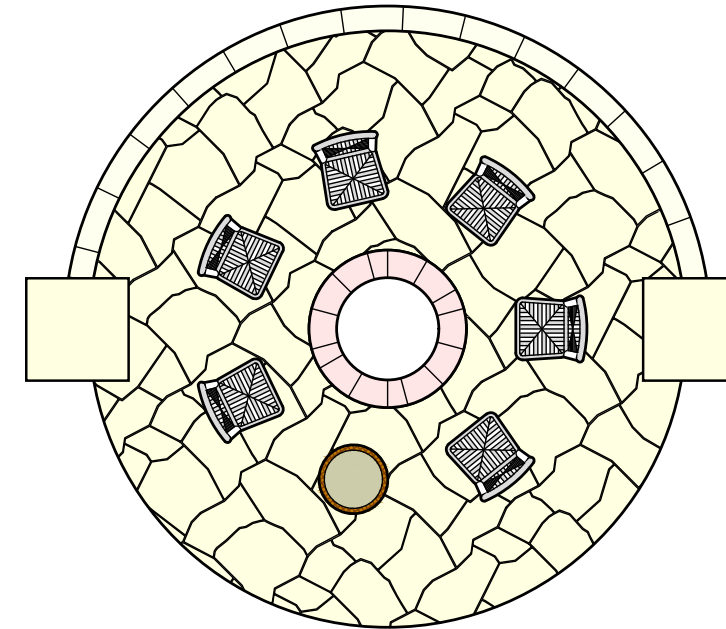

RUSTIC PATIO..... 4
Installation Diagrams..... 6
Construction Tips..... 8
Expense Calculator 9

FORMAL PATIO - OPTION A..... 10
Installation Diagrams..... 12
Construction Tips..... 14
Expense Calculator 15

FORMAL PATIO - OPTION B..... 16
Installation Diagrams.....18
Construction Tips..... 20
Expense Calculator 21
Installation Details 22
Color Swatches..... 26

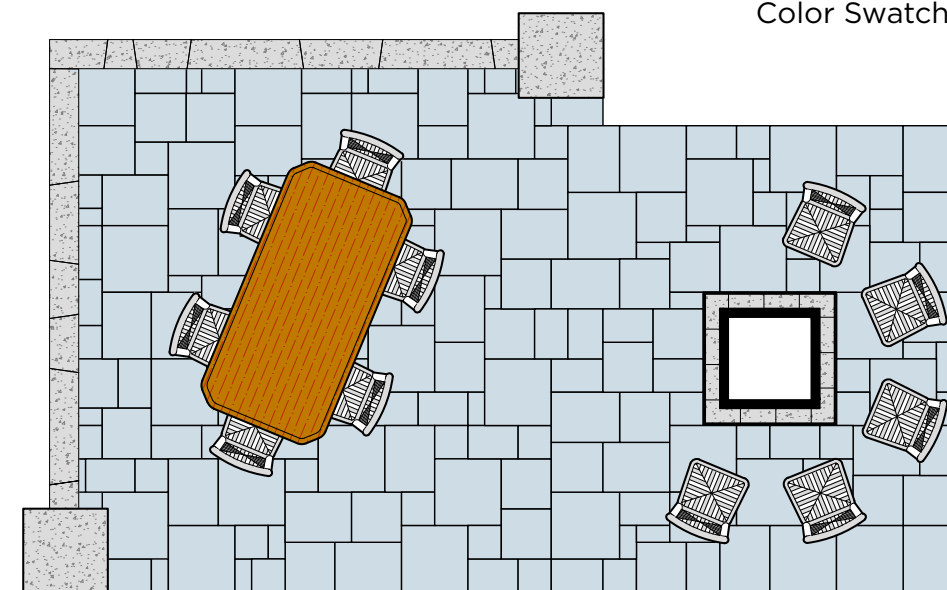



RUSTIC PATIO

258 Square Feet

A round patio says family, community, s'mores, and summer nights. For your customers that appreciate a natural backyard, consider showing them the Rustic Patio option. The rustic option features Grand Flagstone slabs, Belvedere walls, and Belvedere Round Fire Pit Kit for a real stone feel that you won't find in any other hardscape line.

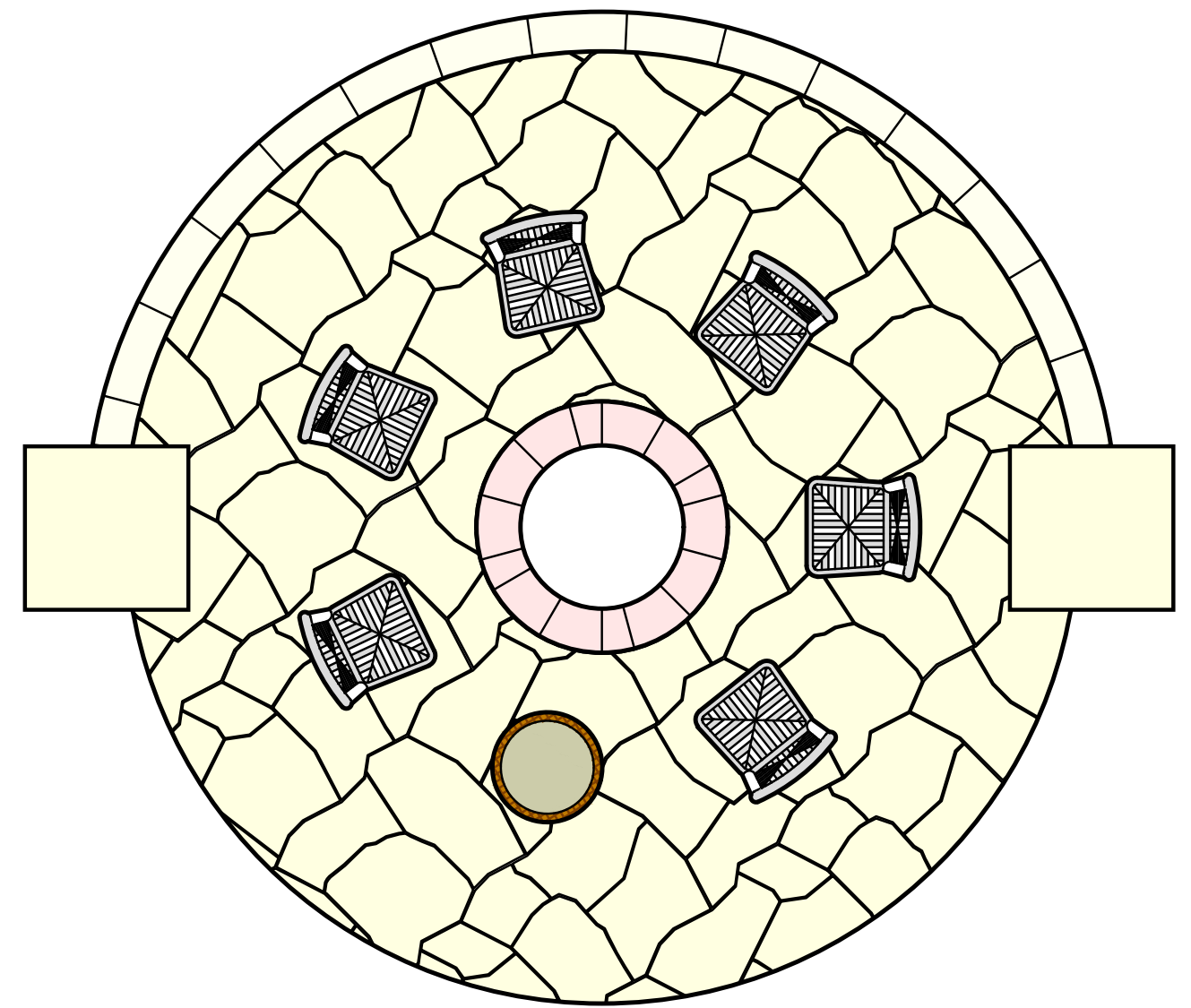

INSTALLATION DIAGRAMS

RUSTIC PATIO

See page 8 for construction tips

Diagram 1

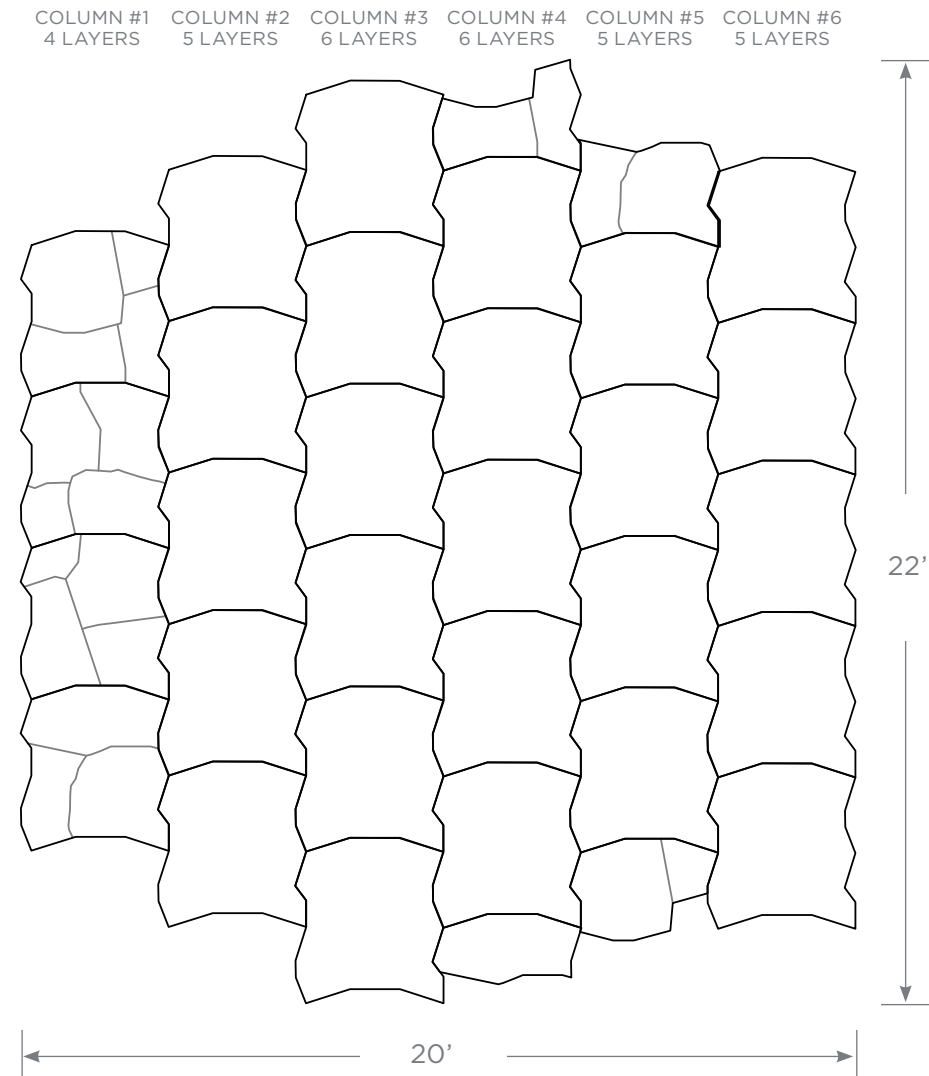

Diagram 2

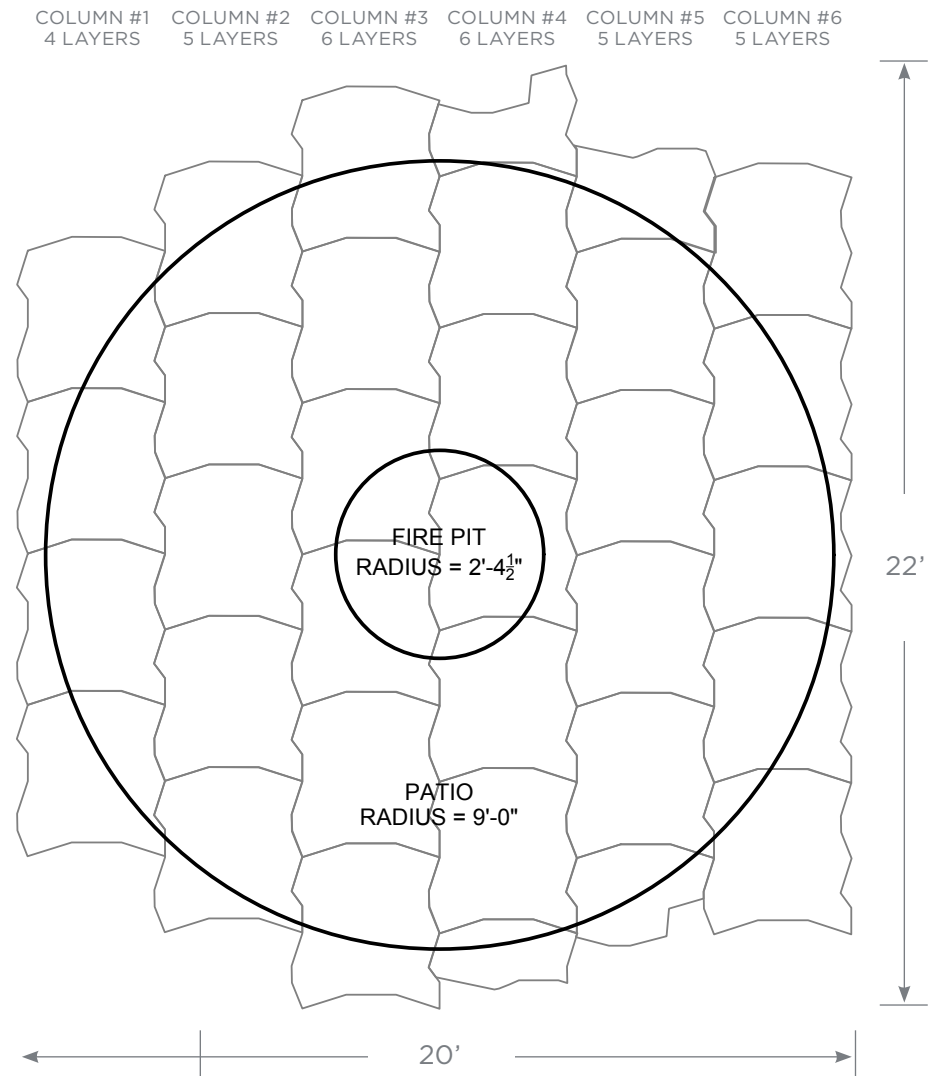
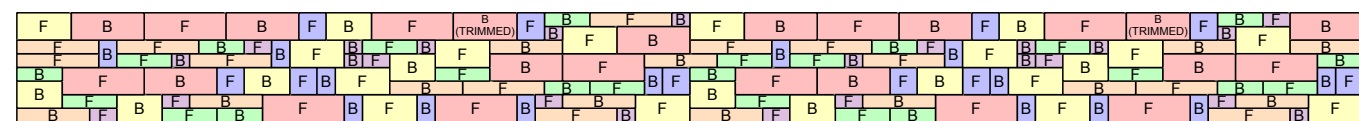

Diagram 3

24 x 2 FOOT FREESTANDING BELVEDERE WALL BLOCK
Profile View



KEY

18 X 6 in	6 X 6 in	12 X 3 in	F = LONG FACE OF BLOCK
12 X 6 in	18 X 3 in	6 X 3 in	B = SHORT FACE OF BLOCK

Diagram 4

APPROXIMATE DIMENSIONAL COPING DIMENSIONS
Alternate between short and long pieces

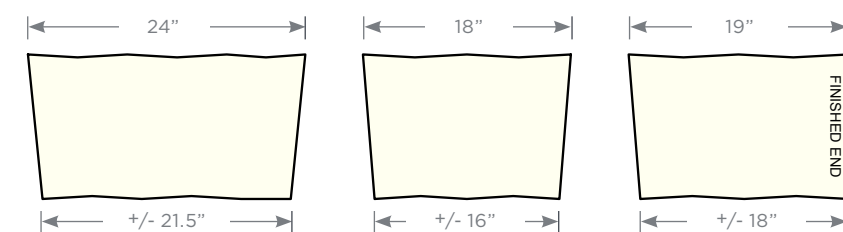

CONSTRUCTION TIPS

RUSTIC PATIO

- Excavate a 20-foot x 22-foot area. Prepare a paver base as detailed on pages 22-23. Keep in mind during excavation that in the finished installation, the top of the Grand Flagstone will be a minimum of 8 3/4 inches above the lowest point of the excavated area.
- Once the base has been prepared, lay the Grand Flagstone in layers, as shown in Diagram 1.
- Once the Grand Flagstone is laid out, locate the center of the patio. From this center point, use a string and a carpenter’s pencil to draw two circles, one with a radius of 2,750 millimeters, the other with a radius of 725 millimeters, as shown in Diagram 2. These will be the outside circumference of the Grand Flagstone, and the circumference of the Round Fire Pit, respectively.
- Once the circles have been marked, trim the Grand Flagstone along the pencil line using a gas-powered cut-off saw with a diamond-coated concrete blade. A hand-grinder or smaller saw may be required to trim the smaller Round Fire Pit circle.
- Remove the trimmed flagstone pieces. If large or unused pieces remain, they can be used as informal stepping stone paths leading to or from the patio.
- Prepare the freestanding Belvedere Wall base along the perimeter of the patio, as detailed on page 25. The finished freestanding wall will span 24 feet.
- Build the freestanding Belvedere Wall as shown in Diagram 3. Be sure to use landscape block adhesive between all courses of block.
- Install Dimensional Coping across the top of the freestanding Belvedere Wall. See Diagram 4 for approximate trimmed dimensions of the coping pieces to make the correct radius atop the wall. Begin with a finished end piece, and after that, alternate between long and short pieces to complete the radius. Check the pieces as you go to ensure that the radius is correct. The final finished end piece may need to be trimmed to a custom length. The coping will overhang the front and back of the wall by approximately 1 3/4 inches.
- Install the Belvedere Round Firepit as detailed on page 24.
- Secure the exposed perimeter of the Grand Flagstone with a low-profile paver edging. A minimum of one stake should be used for every two feet of paver edging (minimum 18 stakes).
- Sweep the patio of dust and debris. Install a jointing material such as paver sand or polymeric sand. Grade topsoil or other finish media to the secured edge of the Grand Flagstone. Plant grass, sod, or landscape plants as desired.

These tips are intended as a supplement to the Oberfields Tech-Guide, which contains detailed product information for all Oberfields products. Get one from your local Oberfields dealer, or download the Tech-Guide at Oberfields.com.

Due to variations in printing, color selections should always be chosen from actual product samples. Textured pavers require a buffer between the plate compactor and paver surface to prevent scuffing. To ensure proper color distribution, mix layers from several bundles at one time.

BREAKDOWN OF PROJECT EXPENSES

RUSTIC PATIO

OBERFIELDS MATERIAL LIST		Approximate Cost
Grand Flagstone	4 pallets	\$ _____
Belvedere Wall	2 pallets	\$ _____
Dimensional Coping	3 layers	\$ _____
Belvedere Round	1 kit	\$ _____
Fire Pit Kit		
MINIMUM BEDDING MATERIALS		
Sub-base Aggregate	7 cubic yards	\$ _____
Bedding Sand	1 1/2 cubic yards	\$ _____
OTHER MATERIALS		
Landscape Adhesive	6 tubes	\$ _____
Polymeric Sand	3 bags	\$ _____
LABOR COST		
Daily Labor Cost	_____ X _____ days	\$ _____
TOTAL ESTIMATED PROJECT COST		\$ _____

Contact your local dealer today for color options and pricing!



FORMAL PATIO

OPTION A

200 Square Feet

Not only does a square patio mean a formal, chic look for your customer, it means straight-forward installation for you and your team. The Formal Patio options in this guide feature Kodah Walls, Dimensional Flagstone slabs, and the Rosetta Dimensional Wall Square Fire Pit, for visually-striking linear proportions and as little concrete cutting as possible.

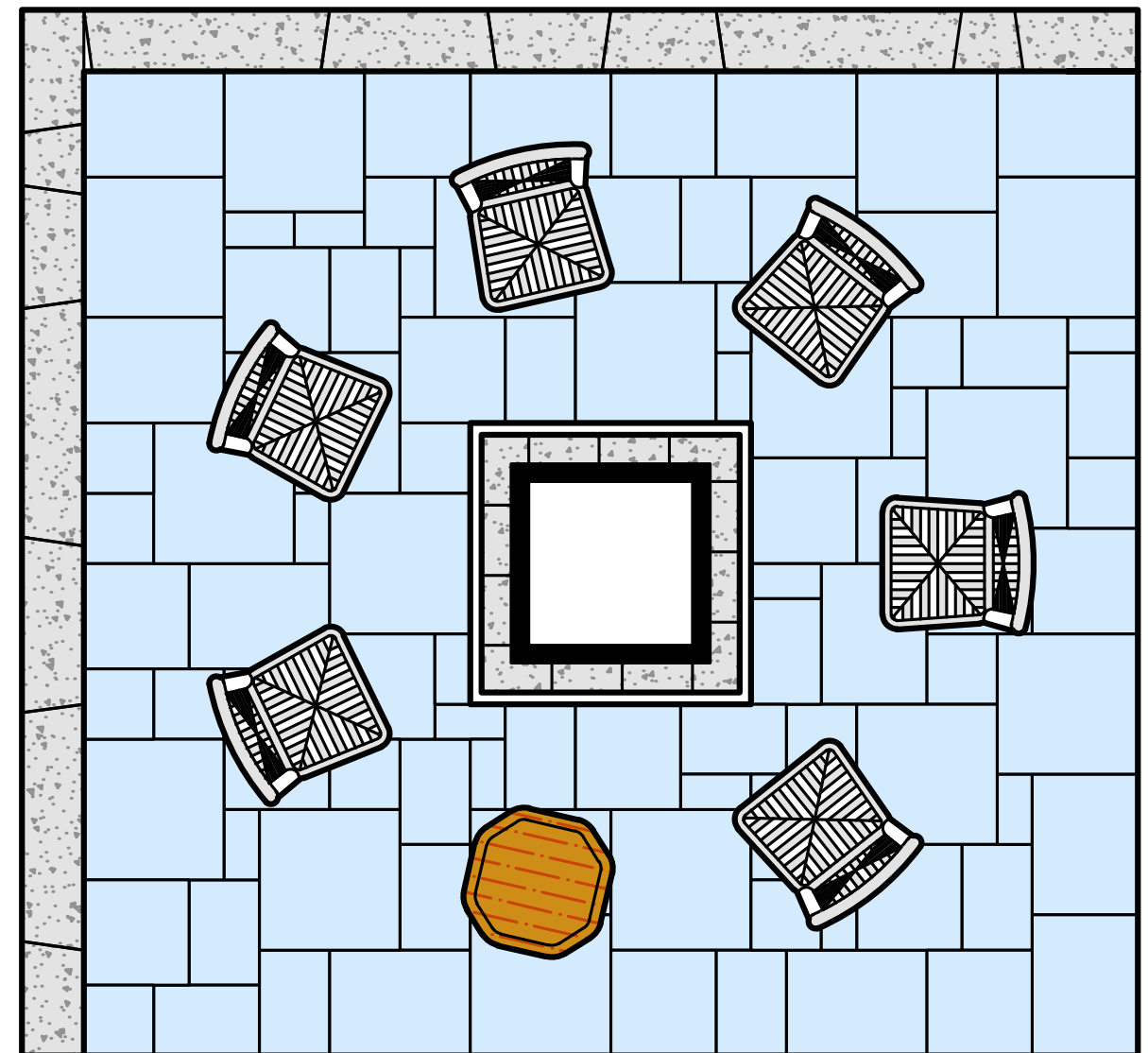

INSTALLATION DIAGRAMS

FORMAL PATIO: OPTION A

See page 14 for construction tips

Diagram 1

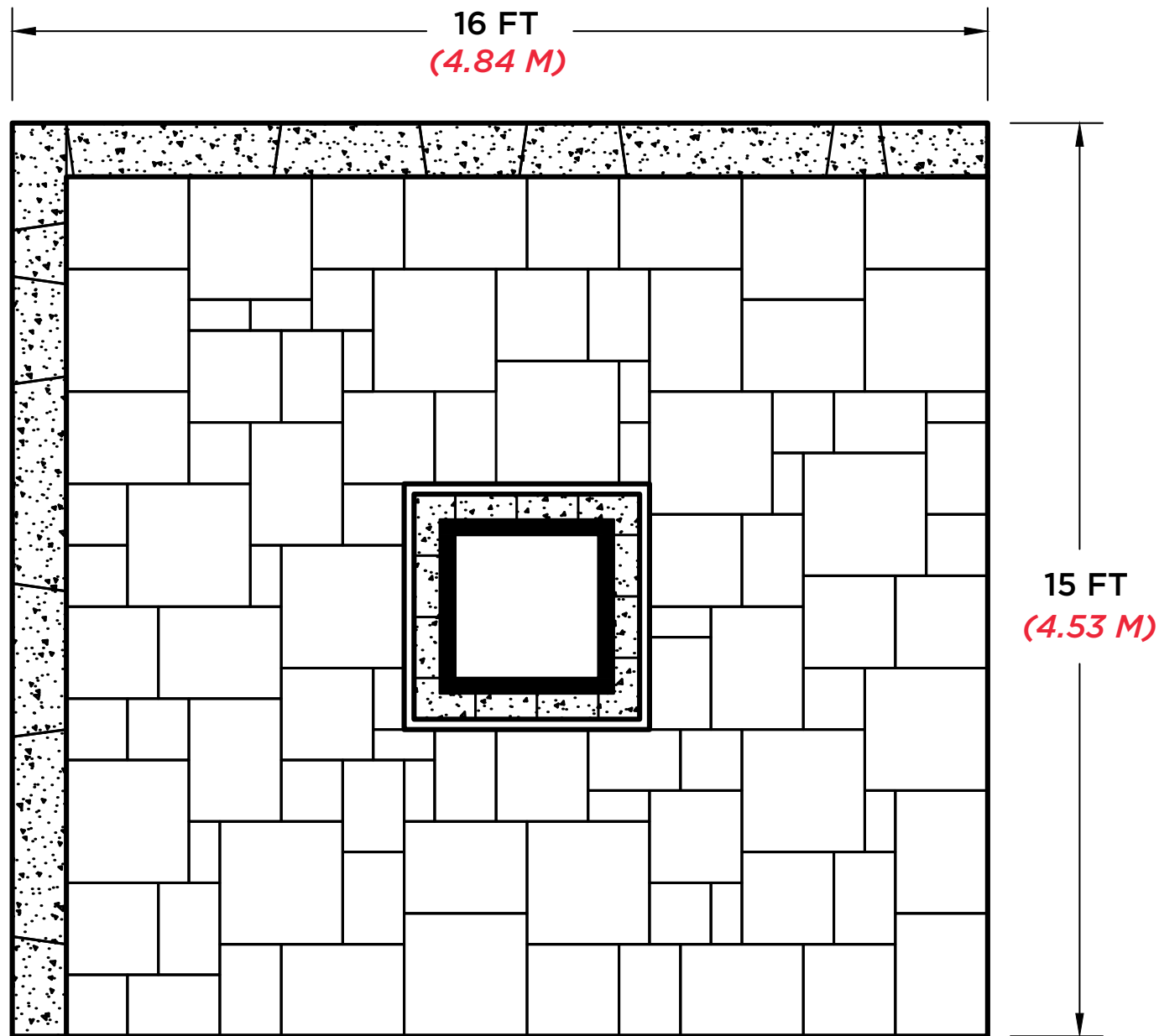
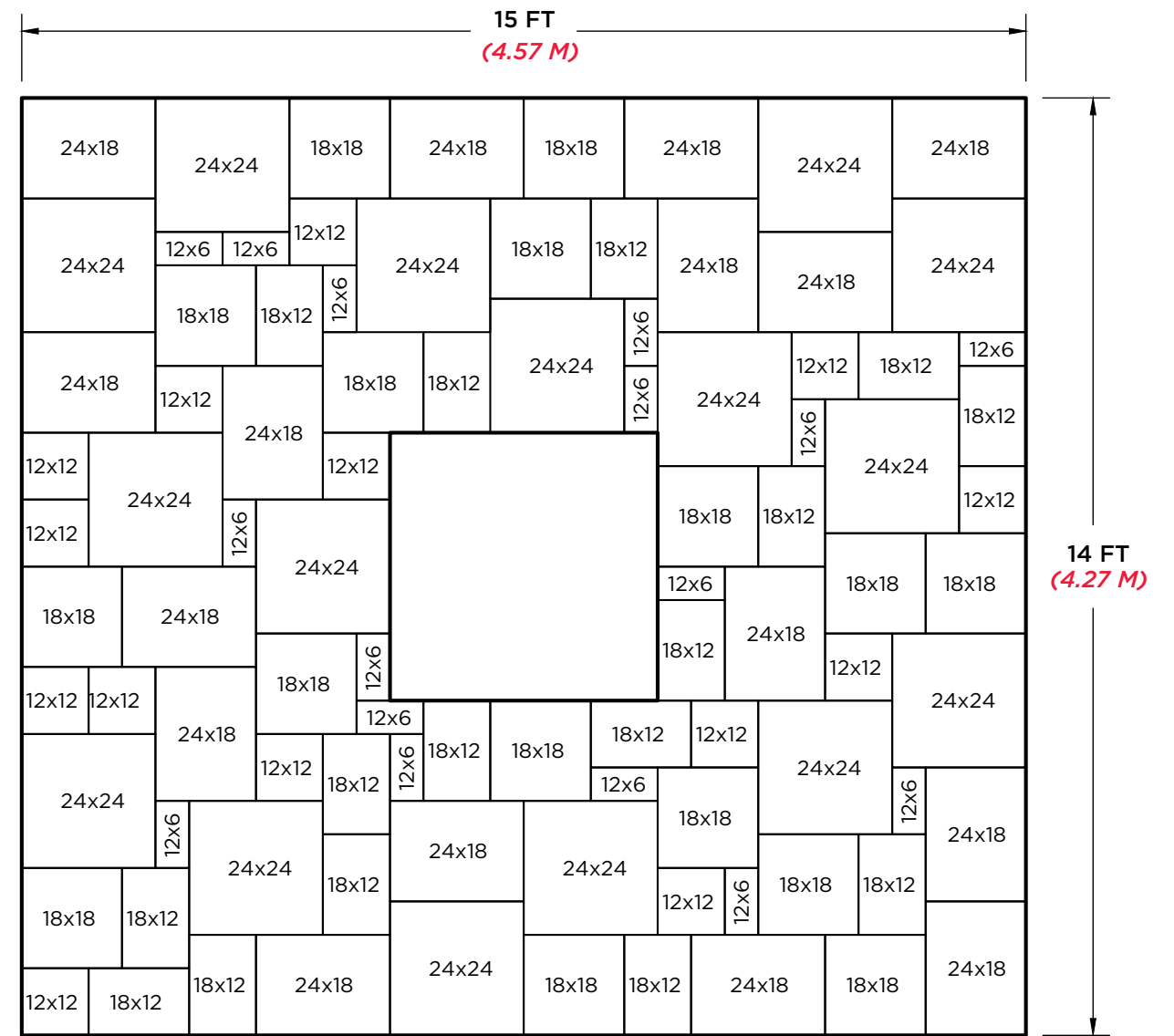

Diagram 2



CONSTRUCTION TIPS

FORMAL PATIO: OPTION A

- Excavate a 17-foot x 17-foot area where the patio will be located. Prepare a paver base as detailed on pages 22-23. Keep in mind during excavation that in the finished installation, the top of the Dimensional Flagstone will be a minimum of 9 inches above the lowest point of the excavated area.
- Once the base has been prepared, lay the Dimensional Flagstone as shown in the pattern on Diagram 2. This pattern will allow you to build the patio utilizing all of the flagstone with no wasted pieces, and with no need to trim pieces.
- Prepare the freestanding Kodah Wall base along the perimeter of the patio, as detailed on pages 22-23. The finished freestanding wall will span two adjoining sides of the patio.
- Starting in the corner, build the freestanding Kodah wall as detailed on page 25. Use corner blocks on the ends and corner of the wall. Be sure to use landscape block adhesive between all courses of block.
- Install Dimensional Coping across the top of the freestanding Kodah Wall. Use landscape block adhesive to adhere the coping to the wall. The coping will overhang the front and back of the wall approximately 1 inch. Trimming may be required on 1-3 pieces of coping.
- Install the Dimensional Square Fire Pit as detailed on page 24. There will be approximately a 2-inch gap between the Square Fire Pit and the Dimensional Flagstone.
- Secure the exposed perimeter of the Dimensional Flagstone with a low-profile paver edging. A minimum of one stake should be used for every 2 feet of paver edging (minimum 16 stakes).
- Sweep the patio free of dust and debris. Install a jointing material such as paver sand or polymeric sand. Grade topsoil or other finish media to the secured edge of the Dimensional Flagstone. Plant grass, sod or landscape plants as desired.

These tips are intended as a supplement to the Oberfields Tech-Guide, which contains detailed product information for all Oberfields products. Get one from your local Oberfields dealer, or download the Tech-Guide at Oberfields.com.

Due to variations in printing, color selections should always be chosen from actual product samples. Textured pavers require a buffer between the plate compactor and paver surface to prevent scuffing. To ensure proper color distribution, mix layers from several bundles at one time.

BREAKDOWN OF PROJECT EXPENSES

FORMAL PATIO: OPTION A

OBERFIELDS MATERIAL LIST		Approximate Cost
Dimensional Flagstone	2 pallets	\$ _____
Kodah Wall	2 pallets +2 layers	\$ _____
Kodah Corners	12 pieces	\$ _____
Dimensional Coping	3 layers	\$ _____
Dimensional Wall	1 kit	\$ _____
Square Fire Pit Kit		
MINIMUM BEDDING MATERIALS		
Sub-base Aggregate	6 cubic yards	\$ _____
Bedding Sand	1 cubic yard	\$ _____
OTHER MATERIALS		
Landscape Adhesive	6 tubes	\$ _____
Polymeric Sand	2 bags	\$ _____
LABOR COST		
Daily Labor Cost	_____ X _____ days	\$ _____
TOTAL ESTIMATED PROJECT COST		\$ _____

Contact your local dealer today for color options and pricing!



FORMAL PATIO

OPTION B

400 Square Feet

Option B extends the surface area of the Formal Patio, so that your customer can dream a little bit bigger about their weekend plans. And with the impressive look and no-nonsense installation of Kodah wall, you'll be your customer's hero.

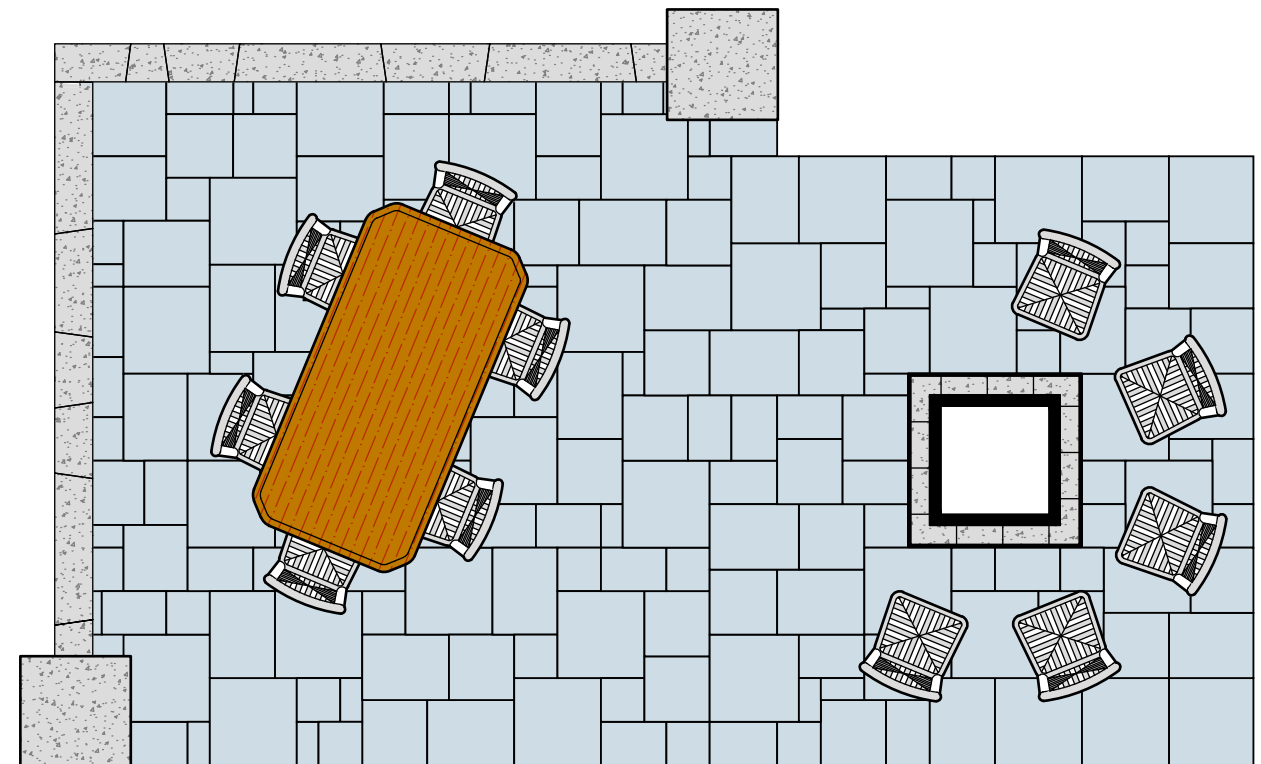

INSTALLATION DIAGRAMS

See page 20 for construction tips

FORMAL PATIO: OPTION B

Diagram 1

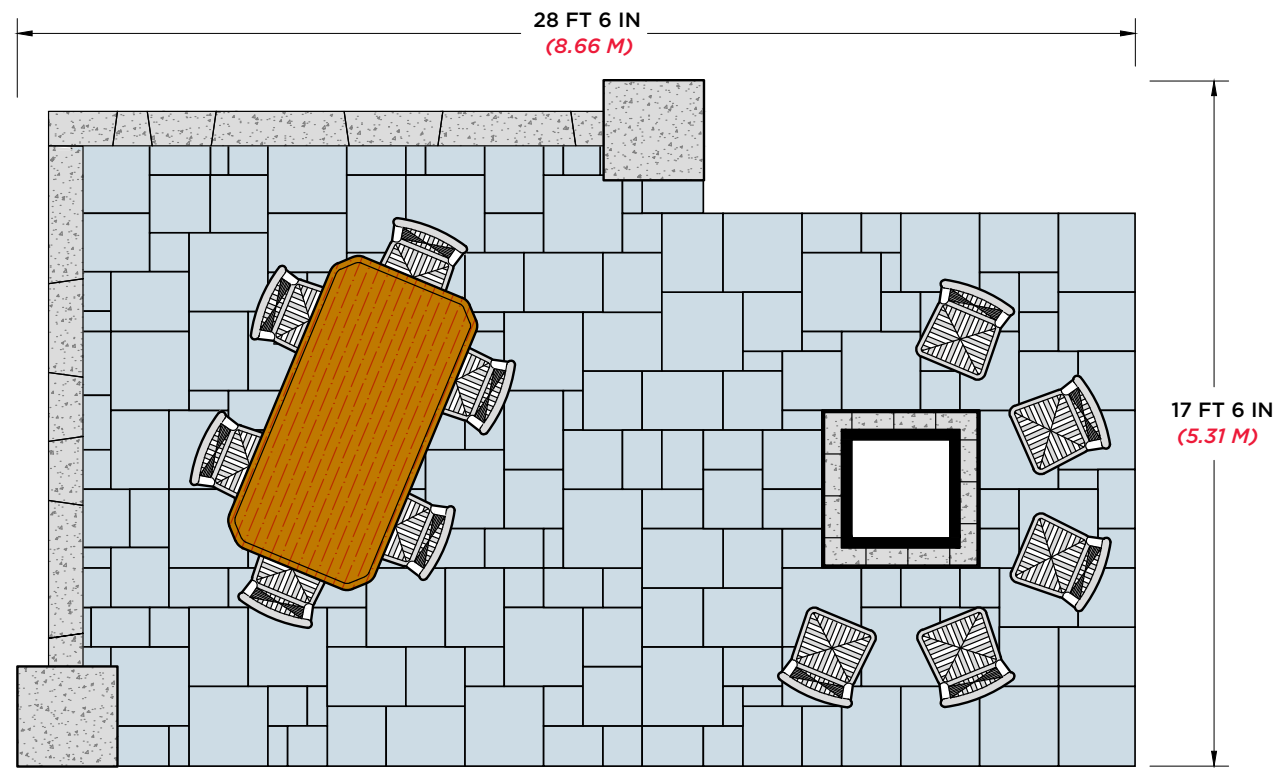

Diagram 3

OPTIONAL PILLAR CONSTRUCTION
Weave the wall into the pillar for additional strength

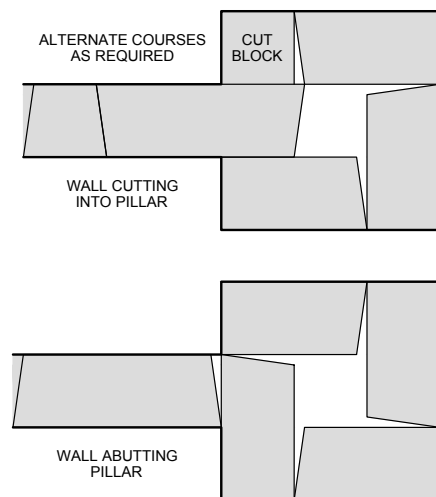
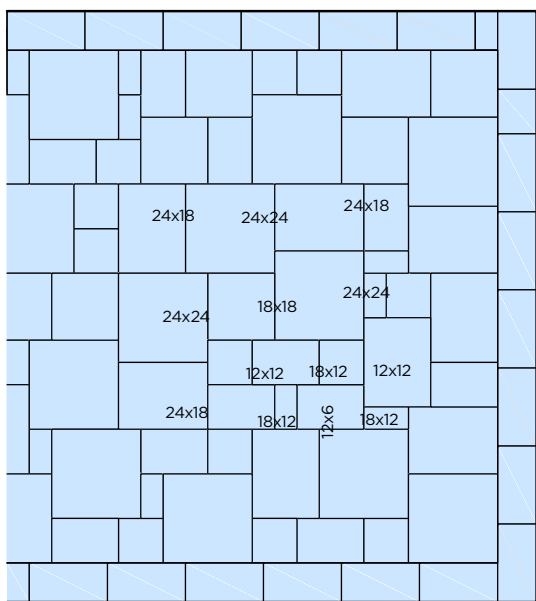

Diagram 4



OPTIONAL PATIO VARIANT

To install the formal patio without a fire pit, add (3) sections of Dimensional Flagstone in place of the Square Fire Pit, and utilize this installation pattern to fill the void in the patio where the firepit would be

Diagram 2

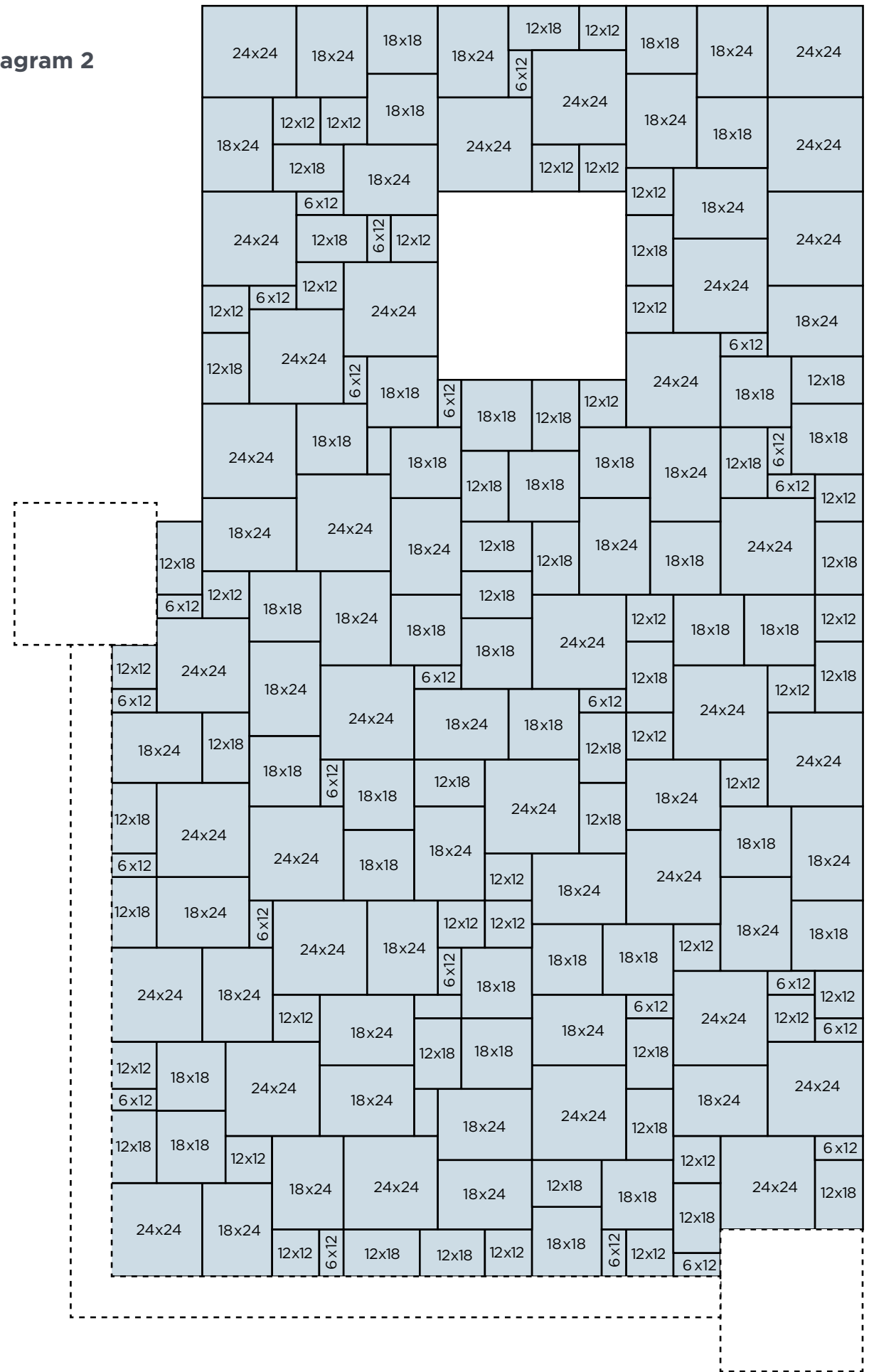

CONSTRUCTION TIPS

FORMAL PATIO: OPTION B

- Excavate a 30-foot x 20-foot area where the patio will be located. Prepare a paver base as detailed on pages 22-23. Keep in mind during excavation that in the finished installation, the top of the Dimensional Flagstone will be a minimum of 9 inches above the lowest point of the excavated area.
- Once the base has been prepared, lay the Dimensional Flagstone as shown in the pattern on Diagram 2. This pattern will allow you to build the patio utilizing all of the flagstone with no wasted pieces, and with minimal trimming.
- Prepare the freestanding Kodah Wall base along the perimeter of the patio, as detailed on page 25. The finished freestanding wall will span two adjoining sides of the patio.
- Starting in the corner, build the freestanding Kodah wall as detailed on page 25. Be sure to use landscape block adhesive between all courses of block. The freestanding Kodah Wall will be four courses high (18 inches above finish grade before the coping is installed).
- Construct the Kodah columns as detailed on page 18. (Optional: for additional wall stability, build the wall “into” the column as shown in Diagram 3.)
- Install Dimensional Coping across the top of the freestanding Kodah Wall. Use landscape block adhesive to adhere the coping to the wall. The coping will overhang the front and back of the wall approximately 1 inch.
- Place the column caps atop the Kodah Columns.
- Install the Dimensional Wall Square Fire Pit as detailed on page 24. (Optional: to install the patio without a Square Fire Pit, follow the guide in Diagram 4.)
- Secure the exposed perimeter of the Dimensional Flagstone with a low-profile paver edging. A minimum of one stake should be used for every two feet of paver edging (minimum 30 stakes).
- Sweep the patio free of dust and debris. Install a jointing material such as paver sand or polymeric sand. Grade topsoil or other finish media to the secured edge of the Dimensional Flagstone. Plant grass, sod or landscape plants as desired.

These tips are intended as a supplement to the Oberfields Tech-Guide, which contains detailed product information for all Oberfields products. Get one from your local Oberfields dealer, or download the Tech-Guide at Oberfields.com.

Due to variations in printing, color selections should always be chosen from actual product samples. Textured pavers require a buffer between the plate compactor and paver surface to prevent scuffing. To ensure proper color distribution, mix layers from several bundles at one time.

BREAKDOWN OF PROJECT EXPENSES

FORMAL PATIO: OPTION B

OBERFIELDS MATERIAL LIST		Approximate Cost
Dimensional Flagstone	4 pallets	\$ _____
Kodah Wall	2 pallets +2 layers	\$ _____
Kodah Corners	3 Pallets +4 pieces	\$ _____
Kodah Pillar Caps	2 pieces	\$ _____
Dimensional Coping	3 layers	\$ _____
Dimensional Wall Square Fire Pit Kit	1 kit	\$ _____
MINIMUM BEDDING MATERIALS		
Sub-base Aggregate	10 cubic yards	\$ _____
Bedding Sand	2 cubic yards	\$ _____
OTHER MATERIALS		
Landscape Adhesive	10 cartridges	\$ _____
Polymeric Sand	4 bags	\$ _____
LABOR COST		
Daily Labor Cost	____ X ____ days	\$ _____
TOTAL ESTIMATED PROJECT COST		\$ _____

Contact your local dealer today for color options and pricing!

FLAGSTONE INSTALLATION

BEDDING SAND INSTALLATION:

Using screed rails on the compacted granular base, apply bedding sand at a maximum thickness of 1" (25mm). By using a screed board along the top of the screed rails, the bedding sand will level evenly. Bedding sand should be compacted since Flagstone slabs should not be compacted after installation.

FLAGSTONE INSTALLATION:

- Begin by laying the individual pieces of Flagstone on the screeded bedding material according to your detailed project plan.
- Separate individual Grand Flagstone pieces approximately 3/8" (10 mm) from each other. When units are set with a 3/8" gap, a full pallet will produce 90 square feet (8.36 m²) of coverage.
- Push Dimensional Flagstone slabs directly together so the bottom edges butt tight. There is no need to space the slabs to create the necessary joint. Joint is pre-set in the unit.
- Cut units as needed to finish edges.
- **NOTE:** To ensure proper color distribution, mix layers from several bundles at one time.

JOINT SAND INSTALLATION:

Once the flagstone pieces are installed, fill all joints with jointing sand suitable for large joints. Sweep the sand into the joints between flagstones until the joints are completely filled. Follow the jointing sand manufacturer's recommendations for wetting the sand. You may need to repeat this process with more dry sand in a few days to completely fill the joints between individual slabs.

CAUTION: Flagstone slabs should not be compacted after installation.

OTHER CONSIDERATIONS:

SEALING: You may want to apply a sealer to protect the flagstone slabs from spills and stains. Always use a high quality sealer specifically formulated for wet-cast concrete.

Not suitable for vehicular traffic

GRAND FLAGSTONE CROSS SECTION

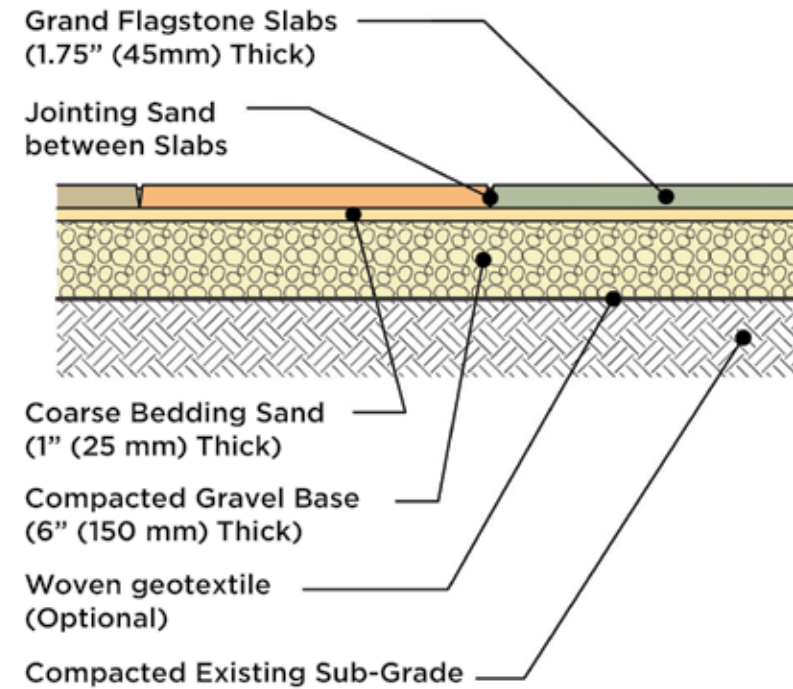

DIMENSIONAL FLAGSTONE CROSS-SECTION

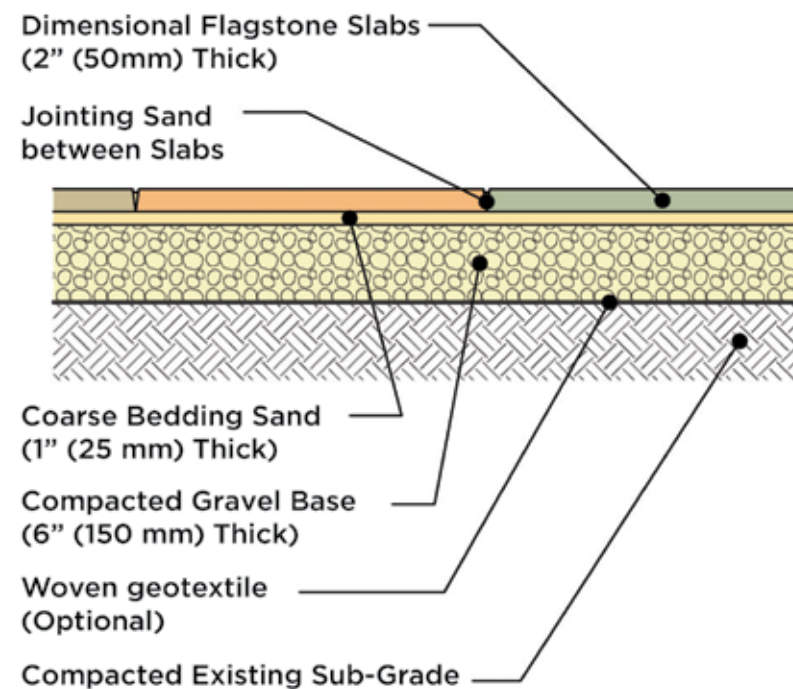

FIRE PIT INSTRUCTIONS

1. Familiarize yourself with the construction details shown on this page.
2. Mark out the location for your fire pit. Note dimensions shown are nominal so mark an area slightly larger than shown.
3. Excavate for drain stone base (approx. 6")
4. Fill excavation with drain stone, level, and compact.
5. Place and center steel ring on prepared base.
6. Place blocks per the pattern. (For Round Kit, keep blocks 1 1/2" off steel ring adversely affect the integrity of the product.)
7. **WARNING:** Do not place Rosetta Fire Pits directly on Rosetta Flagstone product or any comparable concrete product or slab as high heat can damage the area under the fire pit kit.

ADDITIONAL INSTRUCTIONS FOR ROUND FIRE PIT ONLY

8. After placing blocks around the ring, adjust the blocks in or out to make the circle close and fit tight. If the blocks do not close the circle, move all blocks slightly in. If the blocks seem too long, move the blocks slightly out.
9. Place caps in circle around fire pit. Adjust the caps in or out to make them fit tightly together.
10. Note: Not suitable for large fires. Fire size should not allow flame to contact Caps on Round Fire Pit.

BELVEDERE ROUND FIRE PIT

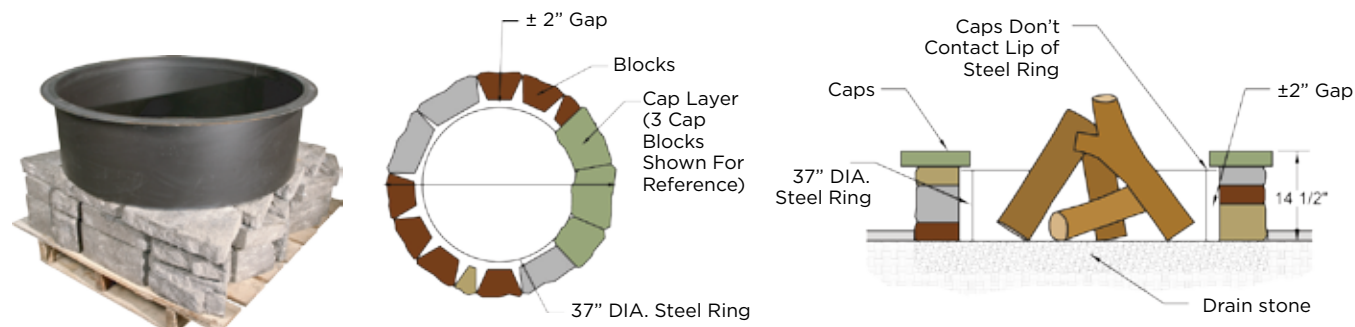

DIMENSIONAL WALL SQUARE FIRE PIT

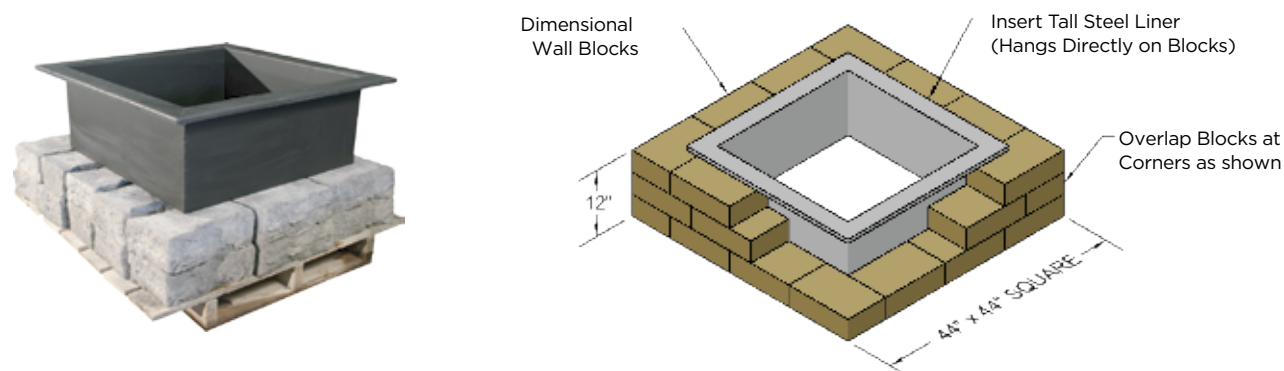

BELVEDERE FREESTANDING WALL

TYPICAL FREESTANDING WALL CONSTRUCTION DETAILS

Belvedere freestanding walls are intended to be low walls (24" or lower) used in a garden or patio setting. Taller walls, walls intended to act as railing or barriers, walls constructed in other settings, or walls subject to applied loads will require project specific engineering.

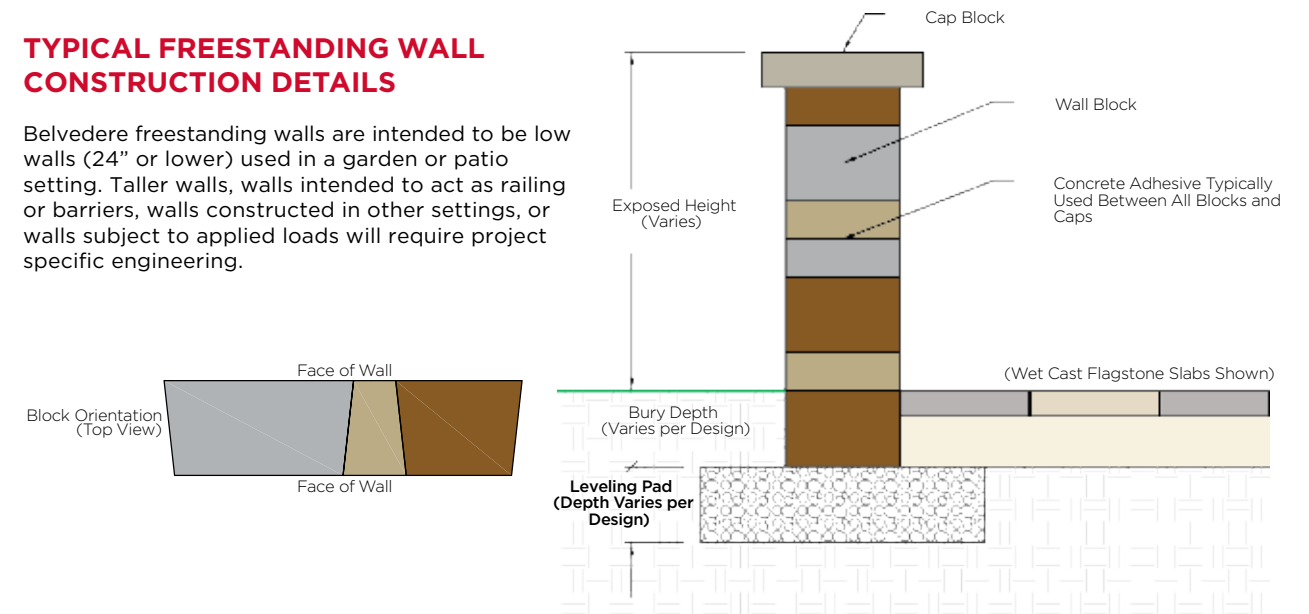

- This drawing is for reference only.
- Final design for construction for walls subject to any loading must be prepared by a registered Professional Engineer.
- Block size and placement shown are for reference only individual Belvedere blocks will vary with installation pattern.

KODAH FREESTANDING WALL

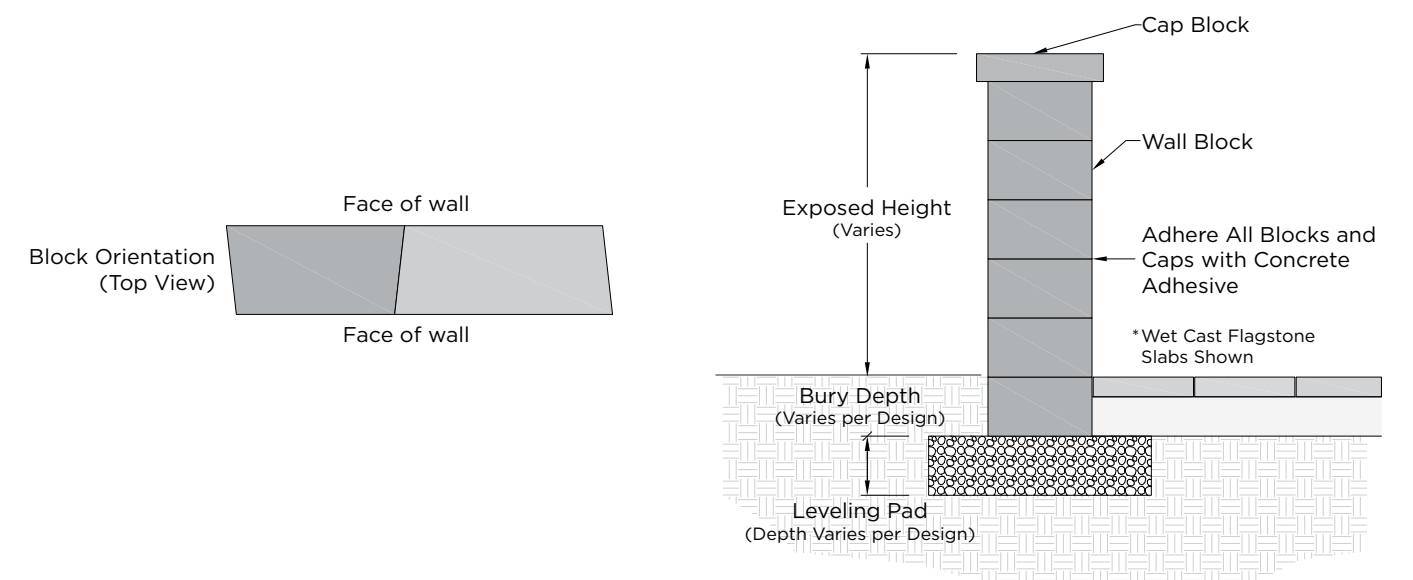

COLOR SWATCHES

RUSTIC OPTION A

Grand Flagstone



Cuyahoga Blend



Scioto Blend

Belvedere Walls



Cuyahoga Blend



Mahoning Blend



Scioto Blend

Round Fire Pit



Cuyahoga Blend



Mahoning Blend



Scioto Blend

Due to variations in printing, color selections should always be chosen from actual product samples. Textured pavers require a buffer between the plate compactor and paver surface to prevent scuffing. To ensure proper color distribution, mix layers from several bundles at one time.

COLOR SWATCHES

FORMAL OPTIONS A & B

Dimensional Flagstone

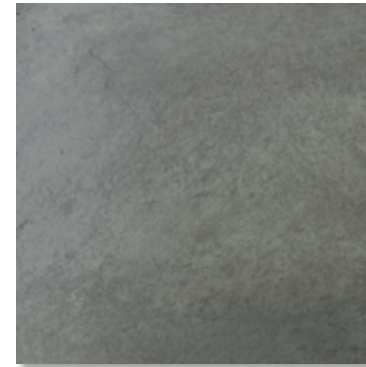

Bluestone Blend



Cuyahoga Blend



Scioto Blend

Kodah Wall



Cuyahoga Blend



Mahoning Blend



Scioto Blend

Square Fire Pit



Cuyahoga Blend



Mahoning Blend

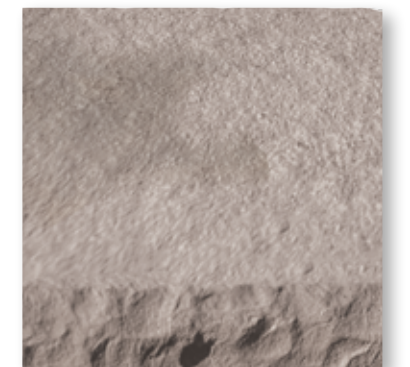

Scioto Blend

Due to variations in printing, color selections should always be chosen from actual product samples. Textured pavers require a buffer between the plate compactor and paver surface to prevent scuffing. To ensure proper color distribution, mix layers from several bundles at one time.



Contact us today for color options and pricing!



oberfields.com