



SALES & MANUFACTURING

Masonry & Landscape
4033 Alum Creek Drive
Obetz, Ohio 43207
614-252-0955
Fax 614-252-5858

Masonry Manufacturing Plant
471 Kintner Pkwy
Sunbury, Ohio 43074
740-965-4141

Sales Distribution Center
10075 Sheehan Road
Centerville, OH 45458
937-885-3711
Fax 937-885-4355

SALES & CORPORATE OFFICE

Landscape & Precast
528 London Road
Delaware, Ohio 43015
614-252-0955
740-369-7644
800-845-7644
Fax 740-363-7644



////////////////////////////////////
**OHIO'S LEADING MANUFACTURER,
MARKETER, AND TECHNICAL
RESOURCE FOR SUPERIOR QUALITY
CONCRETE MASONRY PRODUCTS.**
////////////////////////////////////

oberfields.com



CONCRETE PRODUCTS GROUP

OBERFIELDS LLC is one of 13 original founding members of the Concrete Products Group. The Concrete Products Group (CPG) consists of regional market leaders in the concrete products industry. The CPG is organized to provide consistent, top-quality products to regional and national customers, from a local regional plant to anywhere in the United States. Our products such as Spec-BRIK® WCT (Water Control Technology™), Spec-Finish® and Spec-Thermal™ are produced with consistent specifications and production expertise.

OBERFIELDS LLC IS A PROUD MEMBER OF:

- The Builders Exchange of Central Ohio
- Construction Specification Institute
- National Concrete Masonry Association
- Ohio Masonry Association
- Concrete Products Group

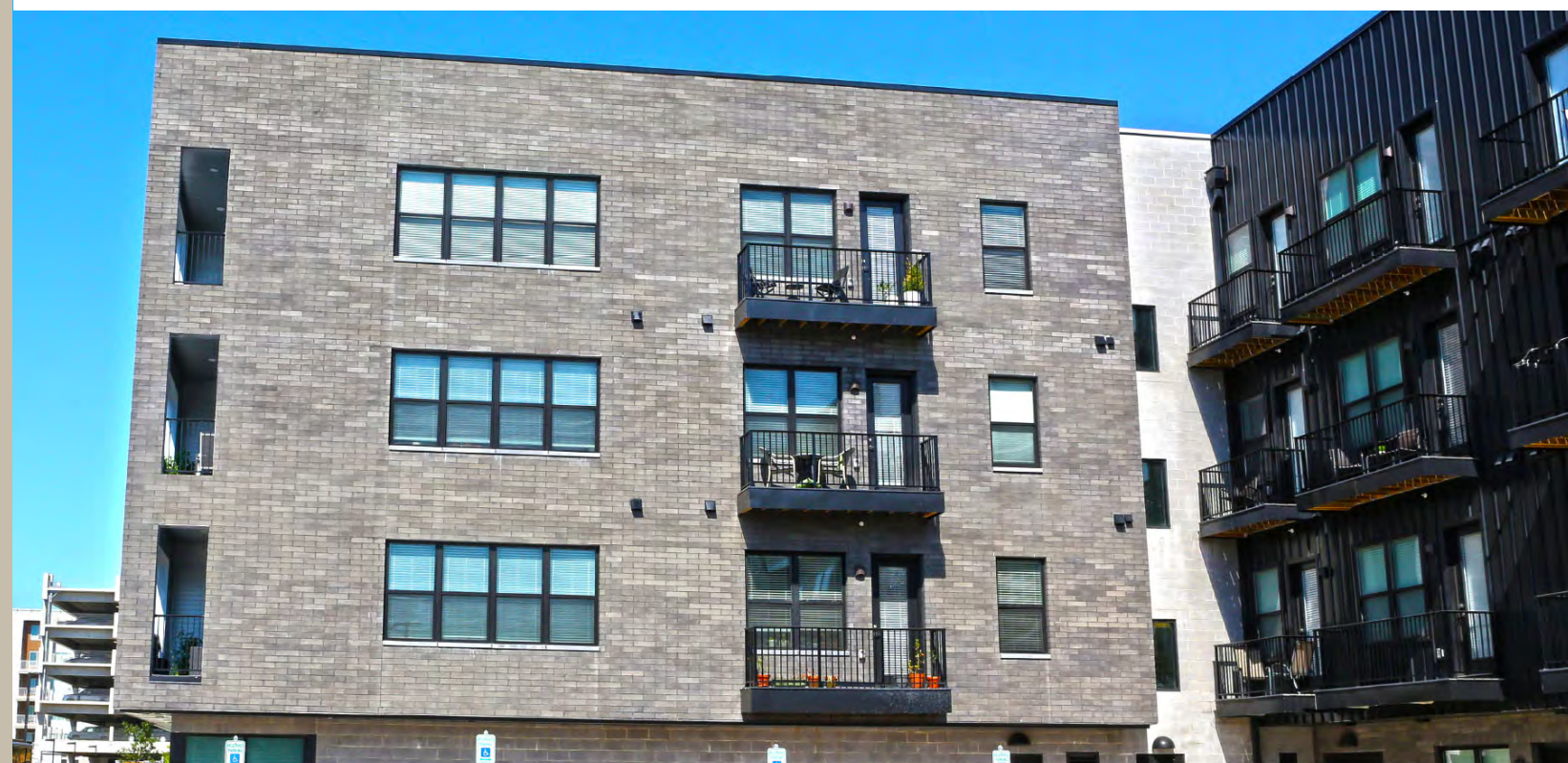

PRODUCT GUIDE INDEX

NOTES

- Safety
- Technical Support
- Fire Rating
- Unit Weight
- Sandblasted Concrete Masonry Units
- Scored Concrete Masonry Units
- Combination Cubes
- West Cubes
- Obtaining Samples
- Product Disclaimer
- Handling DesignBLOK™ Architectural Concrete Masonry Units on the Job

A

STANDARD CONCRETE MASONRY

- Miscellaneous Units 1
- Concrete Brick 1
- 4" Units and 4" Bullnose Units 1-2
- 6" Units and 6" Bullnose Units 2-3
- 8" Units and 8" Bullnose Units 4-7
- 10" Units and 10" Bullnose Units 7-8
- 12" Units and 12" Bullnose Units 8-10
- 14" Units 10
- 16" Units 11-13

DESIGNBLOK™ ARCHITECTURAL CONCRETE MASONRY

- Smooth Face Architectural Units 11-13
- Smooth Scored Architectural Units 13-14
- Split Face 4" Units 14
- Split Face 6" Units 15
- Split Face 8" Units 15-16
- Split Face 10" Units 17
- Split Face 12" Units 17-18
- Scored Split Face Units 19
- Deep 4 Flute Split Face Units 18-19
- 8 Flute Split Face Units 19-20
- Solid Chamfered Sills 20
- ColossalBLOK Units 20
- SoundBLOX Units 21
- Spec-Brik HI-R 21

CORNER AND PIER DETAILS

22-23

ESTIMATING GUIDES

24-25

CLEANING CONCRETE MASONRY

26

WATER CONTROL TECHNOLOGY

26

THE MASONRY PROCESS

27

NOTES

SAFETY

All Oberfields concrete masonry units are manufactured in accordance with ASTM C-90, the industry standard for load bearing concrete masonry units.

Material Safety Data Sheets (MSDS) are available upon request from Oberfields for the products listed in this Guide.

Please note, sawing or grinding of concrete masonry units may result in the release of dust particles, which could cause minor eye or nose irritation if proper protective equipment is not in place. The use of a NIOSH approved respirator and tight goggles is recommended when sawing or grinding operations are in progress. Please contact our Customer Service Center if further information is desired.

TECHNICAL SUPPORT

Oberfields Technical Support Staff will gladly provide written quotations for all your special project needs. To expedite the process, have any dimensional constraints, drawings, and product requirements available for our review.

FIRE RATING

The fire ratings for the concrete masonry units in this Guide were calculated using the equivalent thickness method and based on the use of normal weight aggregates. References include ASTM C90, ASTM C140, TEK 7-1E, International Building Code 2009, and ASTM E119.



Product Description	122	12" x 8" x 16" STRETCHER
Product Number		
Product Dimensions Inches/Millimeters	12" x 8" x 16"	
Ordering Information	UNIT WEIGHT: 51	
Fire Rating	STANDARD CUBE	
Product Illustration with Actual Dimensions	66 PER CUBE	
		RATED 3 HOURS

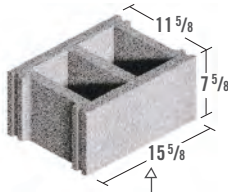

UNIT WEIGHT

All weights shown represent Oberfields standard normal weight concrete masonry units manufactured from natural aggregates. Most shapes and sizes can be special ordered in lightweight or medium weight. Please contact Oberfields Technical Support Staff for additional information.

SANDBLASTED CONCRETE MASONRY UNITS

Sandblasted concrete masonry units are available upon special order. Sandblasted units are manufactured such that the face surface of the unit is sandblasted. Oberfields Technical Support Staff will gladly discuss design options and availability.

SCORED CONCRETE MASONRY UNITS

Oberfields offers vertical scores, or false joints, on the majority of its standard concrete masonry units. Typically, one or three scores are preferred. Also, in some instances, both sides of the standard concrete masonry unit can be scored. Oberfields Technical Support Staff will gladly discuss design options and availability.

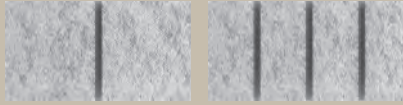

COMBINATION CUBES

Please note on combination cubes that the ratio of one product to another varies from manufacturing plant to manufacturing plant due to differences in mold sizes and configurations. Please call our Technical Support Staff for additional information.

WEST CUBES

West cubes are available for some concrete masonry units. Please contact our Technical Support Staff for availability.

OBTAINING SAMPLES

Samples of colors, textures, weights, sizes, and shapes can be obtained from Oberfields.

PRODUCT DISCLAIMER

The products shown in this Guide are computer-generated images. These images depict standard gray units. Some color differentiation should be expected with architectural concrete masonry units both smooth & split. Variations are to be expected. Should you require a product not cataloged in this Guide, contact our Technical Support Staff for the manufacturing lead time.

HANDLING DESIGNBLOK™ ARCHITECTURAL CONCRETE MASONRY UNITS ON THE JOB

When handling DesignBLOK™ architectural concrete masonry units on the job, avoid stacking palletized cubes one on top of the other. Pallet stain may occur otherwise. Also, given the demand for multiple colored units on the job, prevent the mixing of colors by checking for changes in colors of the units.



ORDERING SUGGESTIONS

The aesthetic beauty and structural characteristics that concrete masonry possess are being recognized and appreciated. It is important that units are ordered correctly the first time to insure the lowest overall cost, while achieving the finest quality and appearance.

1. Check for changes in quantity and color. With multiple colors, due to the use of accent bands and other color combinations, ordering by Oberfields name and number will help to clarify your order.
2. By using Oberfields Concrete Masonry Product Guide, you can order by Oberfields product number to avoid confusion. If the need arises for a shape or size that is not currently cataloged, check with your salesperson or our Technical Support Staff for the manufacturing lead time. Oberfields invites your requests for custom shapes, sizes, aggregates, textures, weights, and colors.
3. For special orders, contact Oberfields Customer Service Department for lead time.
4. Special units such as corners and halves, correctly ordered at the beginning of the project, will aid in color uniformity.
5. When calculating for estimating and dimensioning use width x height x length

MISCELLANEOUS

1 2" x 8" x 16" SOLID

2" x 8" x 16"
51 x 203 x 406
UNIT WEIGHT: 14
ON PALLET
216 PER CUBE

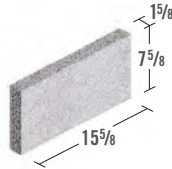

3 3" x 8" x 16" SOLID

3" x 8" x 16"
76 x 203 x 406
UNIT WEIGHT: 22
ON PALLET
144 PER CUBE

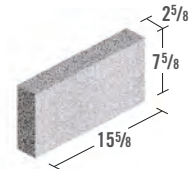

 RATED .75 HOURS

CONCRETE BRICK

8 2" x 4" x 8" CONCRETE BRICK

2" x 4" x 8"
51 x 102 x 203
UNIT WEIGHT: 5
ON PALLET
720 PER CUBE

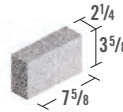

4"

10 4" x 4" x 16" SOLID FROGGED ON TOP

4" x 4" x 16"
102 x 102 x 406
UNIT WEIGHT: 15
ON PALLET
216 PER CUBE

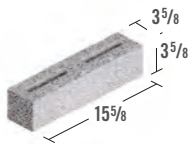

12 4" x 8" x 12" SOLID

4" x 8" x 12"
102 x 203 x 305
UNIT WEIGHT: 23
ON PALLET
144 PER CUBE

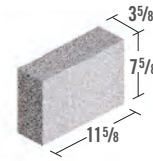

13 4" x 8" x 16" SOLID

4" x 8" x 16"
102 x 203 x 406
UNIT WEIGHT: 31
ON PALLET OR ON 8s
108 PER CUBE

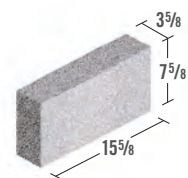

 RATED 1.5 HOURS

14 4" SOLID 45 DEGREE

4" x 8" x 11" x 3"
102 x 203 x 280 x 76
UNIT WEIGHT: 28
ON PALLET
90 PER CUBE
NON-STOCK

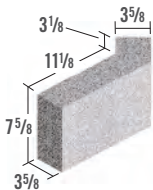

14a 4" x 8" x 16" SOLID L CORNER & END

4" x 8" x 16"
102 x 203 x 406
UNIT WEIGHT: 31
ON PALLET
108 PER CUBE
NON-STOCK

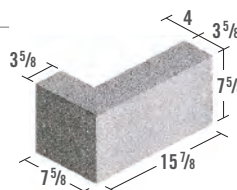

21 4" x 8" x 8" DOUBLE END

4" x 8" x 8"
102 x 203 x 203
UNIT WEIGHT: 11
ON PALLET
216 PER CUBE

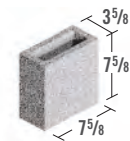

22 4" x 8" x 12" DOUBLE END

4" x 8" x 12"
102 x 203 x 305
UNIT WEIGHT: 16
ON PALLET
144 PER CUBE

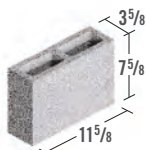

23 4" x 8" x 16" DOUBLE END

4" x 8" x 16"
102 x 203 x 406
UNIT WEIGHT: 23

 RATED 1 HOUR

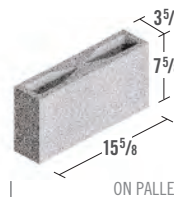

ON PALLET 144 PER CUBE

24 4" x 8" x 16" DOUBLE END BREAKER

4" x 8" x 16"
102 x 203 x 406
UNIT WEIGHT: 24

 RATED 1 HOUR

4" BULLNOSE

27 4" x 8" x 8" SINGLE BULLNOSE & END

4" x 8" x 8"
102 x 203 x 203
UNIT WEIGHT: 11
ON PALLET
216 PER CUBE
NON-STOCK

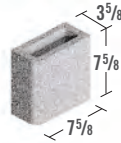

28 4" x 8" x 8" DOUBLE BULLNOSE & END

4" x 8" x 8"
102 x 203 x 203
UNIT WEIGHT: 11
ON PALLET
216 PER CUBE
NON-STOCK

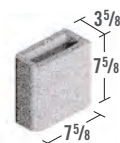

29 4" x 8" x 12" SINGLE BULLNOSE & END

4" x 8" x 12"
102 x 203 x 305
UNIT WEIGHT: 16
ON PALLET
144 PER CUBE
NON-STOCK

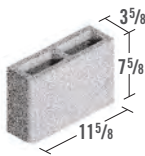

30 4" x 8" x 16" SINGLE BULLNOSE & END

4" x 8" x 16"
102 x 203 x 406
UNIT WEIGHT: 24
ON PALLET
144 PER CUBE
NON-STOCK

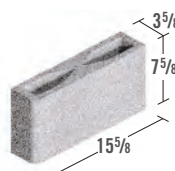

31 4" x 8" x 16" DOUBLE BULLNOSE & END

4" x 8" x 16"
102 x 203 x 406
UNIT WEIGHT: 24
ON PALLET
144 PER CUBE
NON-STOCK

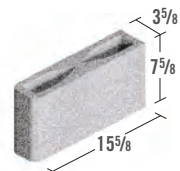

6"

32 6" x 8" x 16" SOLID

6" x 8" x 16"
152 x 203 x 406
UNIT WEIGHT: 46
ON PALLET
72 PER CUBE

 RATED 3 HOURS

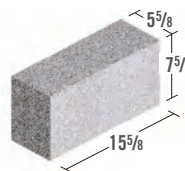

37 6" x 6" x 16" DOUBLE END

6" x 6" x 16"
152 x 152 x 406
UNIT WEIGHT: 19
NON-STOCK

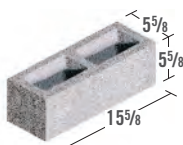

38 6" x 6" x 16" DOUBLE END BREAKER

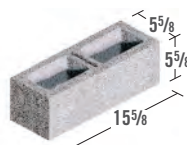

39 6" x 6" x 16" DOUBLE SASH BREAKER

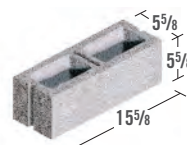

39a 6" x 6" x 16" SASH & END

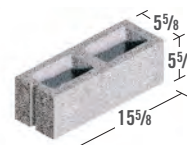

STANDARD CUBE 144 PER CUBE

33 6" x 4" x 16" DOUBLE END

6" x 4" x 16"
152 x 102 x 406
UNIT WEIGHT: 14
NON-STOCK

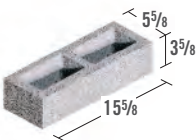

34 6" x 4" x 16" DOUBLE END BREAKER

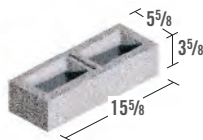

35 6" x 4" x 16" DOUBLE SASH BREAKER

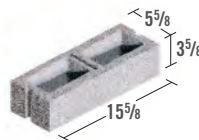

35a 6" x 4" x 16" SASH & END

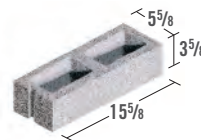

STANDARD CUBE 192 PER CUBE

41 6" x 8" x 8" SASH & END

6" x 8" x 8"
152 x 203 x 203
UNIT WEIGHT: 17
ON PALLET
216 PER CUBE

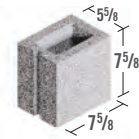

42 6" x 8" x 14" DOUBLE END

6" x 8" x 14"
152 x 203 x 356
UNIT WEIGHT: 23
ON PALLET
126 PER CUBE
NON-STOCK

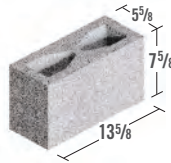

43 6" x 8" x 16" DOUBLE END

6" x 8" x 16"
152 x 203 x 406
UNIT WEIGHT: 28

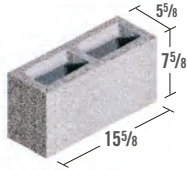

44 6" x 8" x 16" DOUBLE END BREAKER

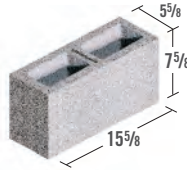

45 6" x 8" x 16" SASH & END

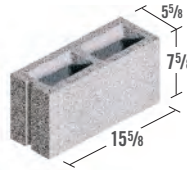

46 6" x 8" x 16" DOUBLE SASH BREAKER

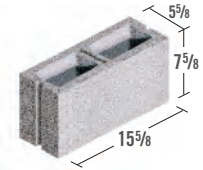

 **RATED 1 HOUR**

STANDARD CUBE 108 PER CUBE

48 6" x 8" x 16" U BOND BEAM

6" x 8" x 16"
152 x 203 x 406
UNIT WEIGHT: 28
ON PALLET
96 PER CUBE
NON-STOCK

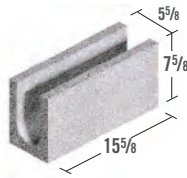

6" BULLNOSE

50 6" x 8" x 8" SINGLE BULLNOSE & END

6" x 8" x 8"
152 x 203 x 203
UNIT WEIGHT: 17
ON PALLET
216 PER CUBE
NON-STOCK

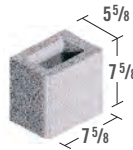

51 6" x 8" x 8" DOUBLE BULLNOSE & END

6" x 8" x 8"
152 x 203 x 203
UNIT WEIGHT: 17
ON PALLET
216 PER CUBE
NON-STOCK



53 6" x 8" x 16" SINGLE BULLNOSE & END

6" x 8" x 16"
152 x 203 x 406
UNIT WEIGHT: 29
ON PALLET
108 PER CUBE
NON-STOCK

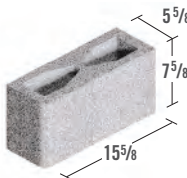

54 6" x 8" x 16" DOUBLE BULLNOSE & END

6" x 8" x 16"
152 x 203 x 406
UNIT WEIGHT: 29
ON PALLET
108 PER CUBE
NON-STOCK

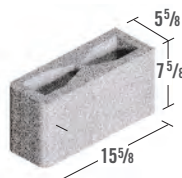

8" UNITS

55 8" x 8" x 16" SOLID

8" x 8" x 16"
203 x 203 x 406
UNIT WEIGHT: 63
ON PALLET
54 PER CUBE
 RATED 4 HOURS

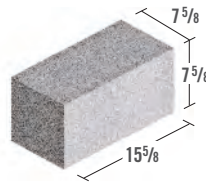

56 8" x 8" x 16" SOLID HEADER

8" x 8" x 16"
203 x 203 x 406
UNIT WEIGHT: 48
ON 8s
72 PER CUBE

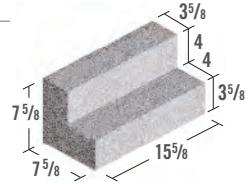

59 8" x 4" x 16" DOUBLE END*

8" x 4" x 16"
203 x 102 x 406
UNIT WEIGHT: 17

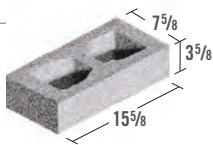

61 8" x 4" x 16" SASH & END*

8" x 4" x 16"
203 x 102 x 406
UNIT WEIGHT: 17

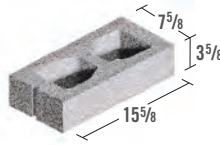

63a 8" x 4" x 16" RESTRICTED BOND BEAM

8" x 4" x 16"
203 x 102 x 406
UNIT WEIGHT: 17
ON PALLET
144 PER CUBE
NON-STOCK

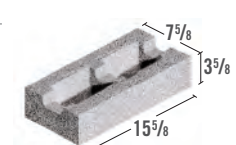

64 8" x 6" x 16" DOUBLE END*

8" x 6" x 16"
203 x 152 x 406
UNIT WEIGHT: 25
NON-STOCK

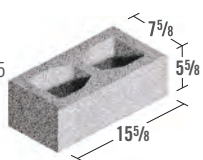

65 8" x 6" x 16" DOUBLE END BREAKER*

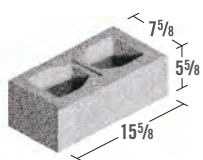

66 8" x 6" x 16" SASH & END*

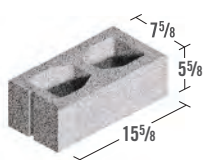

67 8" x 6" x 16" DOUBLE SASH BREAKER*

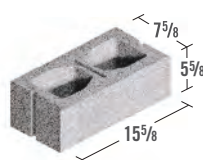

68 8" x 6" x 16" DOUBLE END*

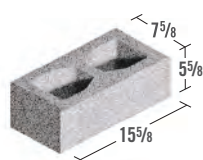

ON PALLET 90 PER CUBE

69 8" x 8" x 8" SASH & END

8" x 8" x 8"
203 x 203 x 203
UNIT WEIGHT: 21
ON PALLET
144 PER CUBE

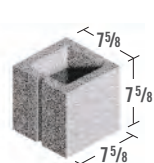

70 8" x 8" x 12" DOUBLE END

8" x 8" x 12"
203 x 203 x 305
UNIT WEIGHT: 29
ON PALLET
120 PER CUBE

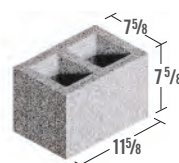

71 8" 45 DEGREE

8" x 8" x 8" x 11"
203 x 203 x 203 x 279
UNIT WEIGHT: 29
ON PALLET
120 PER CUBE

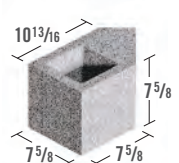

72 8" x 8" x 16" STRETCHER

8" x 8" x 16"
203 x 203 x 406
UNIT WEIGHT: 34

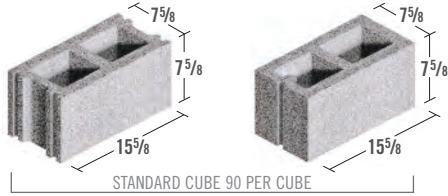

 RATED 1 HOURS

73 8" x 8" x 16" SASH & END

8" x 8" x 16"
203 x 203 x 406
UNIT WEIGHT: 35

 RATED 1 HOURS

74 8" x 8" x 16" 2 HOUR STRETCHER

8" x 8" x 16"
203 x 203 x 406
UNIT WEIGHT: 36

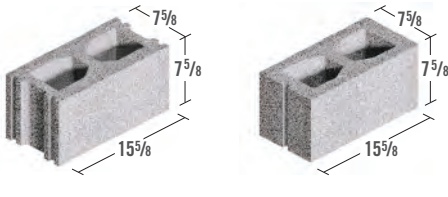

 RATED 2 HOURS

75 8" x 8" x 16" 2 HOUR SASH & END

8" x 8" x 16"
203 x 203 x 406
UNIT WEIGHT: 36

 RATED 2 HOURS

76 8" x 8" x 16" 3 HOUR STRETCHER

8" x 8" x 16"
203 x 203 x 406
UNIT WEIGHT: 42

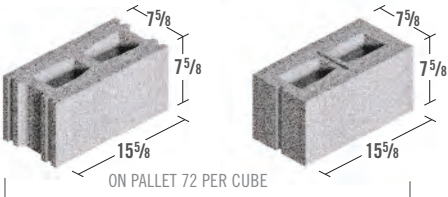

 RATED 3 HOURS

77 8" x 8" x 16" 3 HOUR SASH & END BREAKER

8" x 8" x 16"
203 x 203 x 406
UNIT WEIGHT: 44

 RATED 3 HOURS

80 8" x 8" x 16" DOUBLE END

8" x 8" x 16"
203 x 203 x 406
UNIT WEIGHT: 36
ON PALLET
90 PER CUBE

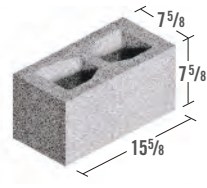

81 8" x 8" x 16" SASH & END

8" x 8" x 16"
203 x 203 x 406
UNIT WEIGHT: 36
ON PALLET
90 PER CUBE

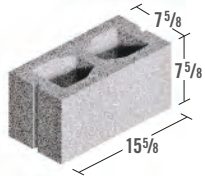

82 8" x 8" x 16" WEEP

8" x 8" x 16"
203 x 203 x 406
UNIT WEIGHT: 33
STANDARD CUBE
90 PER CUBE

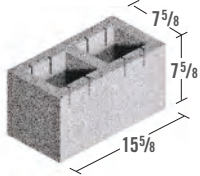

83 8" x 8" x 16" TERMITE

8" x 8" x 16"
203 x 203 x 406
UNIT WEIGHT: 43

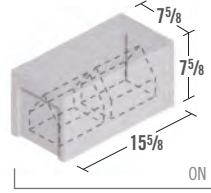

84 8" x 8" x 16" TERMITE SASH & END

8" x 8" x 16"
203 x 203 x 406
UNIT WEIGHT: 50

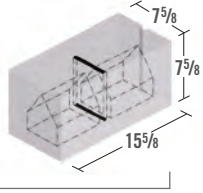

84a 8" x 8" x 16" OPEN CELL TERMITE

8" x 8" x 16"
203 x 203 x 406
UNIT WEIGHT: 38
ON (18) 8" HC
72 PER CUBE

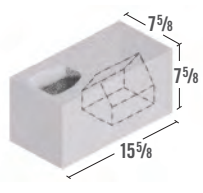

85 8" x 8" x 16" U SOLID BOTTOM BOND BEAM

8" x 8" x 16"
203 x 203 x 406
UNIT WEIGHT: 45
ON PALLET
90 PER CUBE

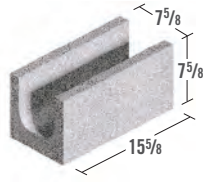

86 8" x 8" x 16" OPEN BOTTOM BOND BEAM

8" x 8" x 16"
203 x 203 x 406
UNIT WEIGHT: 37
ON PALLET
90 PER CUBE
NON-STOCK

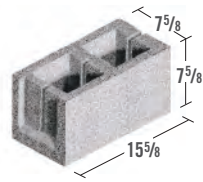

87 8" x 8" x 16" RESTRICTED BOND BEAM

8" x 8" x 16"
203 x 203 x 406
UNIT WEIGHT: 32
ON PALLET
90 PER CUBE

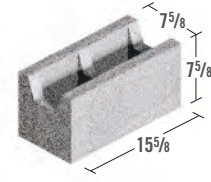

88 8" x 8" x 16" GROUT

8" x 8" x 16"
203 x 203 x 406
UNIT WEIGHT: 34
ON PALLET
90 PER CUBE
NON-STOCK

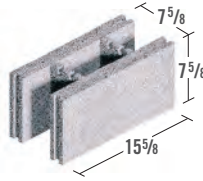

88a 8" x 8" x 16" OPEN END REBAR

8" x 8" x 16"
203 x 203 x 406
UNIT WEIGHT: 33
ON PALLET
90 PER CUBE

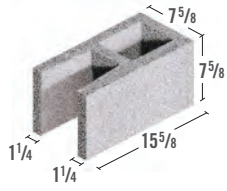

88b 8" x 8" x 16" DOUBLE OPEN END BOND BEAM

8" x 8" x 16"
203 x 203 x 406
UNIT WEIGHT: 32
ON PALLET
90 PER CUBE
NON-STOCK

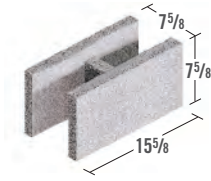

88c 8" x 8" x 16" BEAM INTEL

8" x 8" x 16"
203 x 203 x 406
UNIT WEIGHT: 36
ON PALLET
90 PER CUBE
NON-STOCK

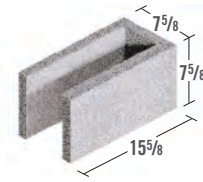

89 8" x 8" x 16" KNOCK-OUT PIPE CHASE

8" x 8" x 16"
203 x 203 x 406
UNIT WEIGHT: 35
ON PALLET
90 PER CUBE

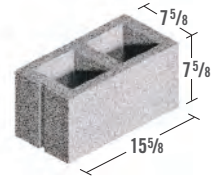

8" BULLNOSE

91 8" x 8" x 8" SINGLE BULLNOSE & END

8" x 8" x 8"
203 x 203 x 203
UNIT WEIGHT: 21
ON PALLET
144 PER CUBE

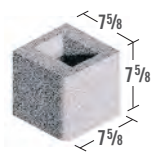

92 8" x 8" x 8" DOUBLE BULLNOSE & END

8" x 8" x 8"
203 x 203 x 203
UNIT WEIGHT: 21
ON PALLET
144 PER CUBE

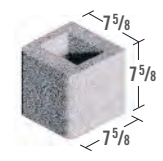

93 8" x 8" x 16" SINGLE BULLNOSE & END

8" x 8" x 16"
203 x 203 x 406
UNIT WEIGHT: 38
ON PALLET
90 PER CUBE

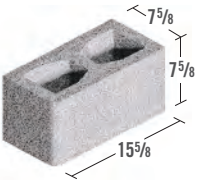

94 8" x 8" x 16" DOUBLE BULLNOSE & END

8" x 8" x 16"
203 x 203 x 406
UNIT WEIGHT: 38
ON PALLET
90 PER CUBE

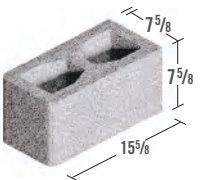

99 8" x 8" x 16" BULLNOSE DOUBLE END (PILASTER)

8" x 8" x 16"
203 x 203 x 406
UNIT WEIGHT: 38
ON PALLET
90 PER CUBE
NON-STOCK

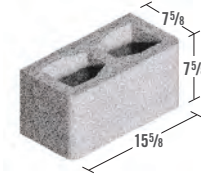

10"

101 10" x 8" x 16" SOLID

10" x 8" x 16"
254 x 203 x 406
UNIT WEIGHT: 84
ON PALLET
45 PER CUBE
NON-STOCK
🔥 RATED 4 HOURS

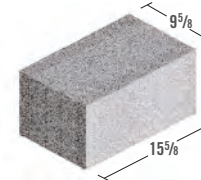

104 10" x 8" x 8" SASH & END

10" x 8" x 8"
254 x 203 x 203
UNIT WEIGHT: 25
ON PALLET
90 PER CUBE

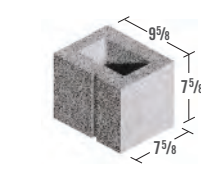

105 10" x 8" x 16" STRETCHER

10" x 8" x 16"
254 x 203 x 406
UNIT WEIGHT: 44

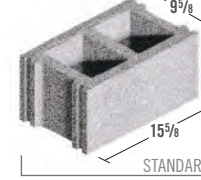

🔥 RATED 3 HOURS

106 10" x 8" x 16" SASH & END BREAKER

10" x 8" x 16"
254 x 203 x 406
UNIT WEIGHT: 48

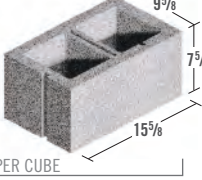

🔥 RATED 3 HOURS

107 10" x 8" x 16" WEEP

10" x 8" x 16"
254 x 203 x 406
UNIT WEIGHT: 46
STANDARD CUBE
72 PER CUBE
NON-STOCK

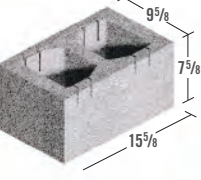

108 10" x 8" x 16" OPEN BOTTOM BOND BEAM

10" x 8" x 16"
254 x 203 x 406
UNIT WEIGHT: 48
STANDARD CUBE
75 PER CUBE
NON-STOCK

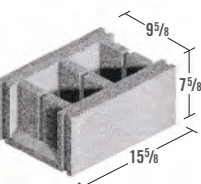

109 10" x 8" x 16" TERMITE OR BOND BEAM

10" x 8" x 16"
254 x 203 x 406
UNIT WEIGHT: 50
ON PALLET
60 PER CUBE

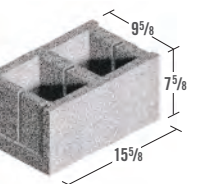

110 10" x 8" x 16" RETURN CORNER

10" x 8" x 16"
254 x 203 x 406
UNIT WEIGHT: 43
ON PALLET
72 PER CUBE

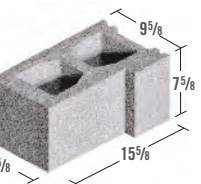

111 10" x 8" x 16" KNOCK-OUT PIPE CHASE

10" x 8" x 16"
254 x 203 x 406
UNIT WEIGHT: 48
ON PALLET
75 PER CUBE
NON-STOCK

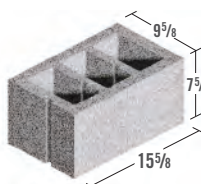

112 10" x 8" x 8" SINGLE BULLNOSE & END

10" x 8" x 8"
254 x 203 x 203
UNIT WEIGHT: 25
ON PALLET
90 PER CUBE
NON-STOCK

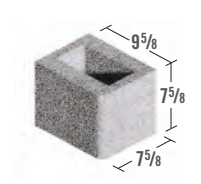

10" BULLNOSE

113 10" x 8" x 16" SINGLE BULLNOSE & END

10" x 8" x 16"
254 x 203 x 406
UNIT WEIGHT: 50
ON PALLET
75 PER CUBE
NON-STOCK

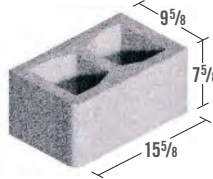

114 10" x 8" x 16" DOUBLE BULLNOSE & END

10" x 8" x 16"
254 x 203 x 406
UNIT WEIGHT: 50
ON PALLET
75 PER CUBE
NON-STOCK

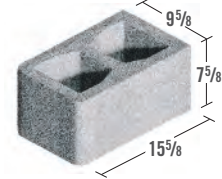

12"

115 12" x 4" x 16" SOLID

12" x 4" x 16"
305 x 102 x 406
UNIT WEIGHT: 48
ON PALLET
72 PER CUBE

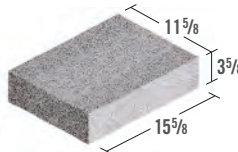

116 12" x 8" x 16" SOLID

12" x 8" x 16"
305 x 203 x 406
UNIT WEIGHT: 99
ON PALLET
36 PER CUBE

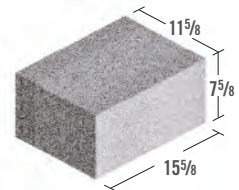

 **RATED 4 HOURS**

117a 12" x 4" x 16" DOUBLE END

12" x 4" x 16"
305 x 102 x 406
UNIT WEIGHT: 23

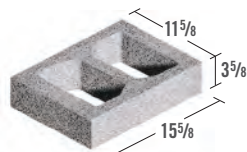

117a 12" x 4" x 16" DOUBLE END

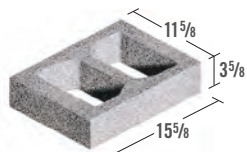

118 12" x 4" x 16" SASH & END BREAKER

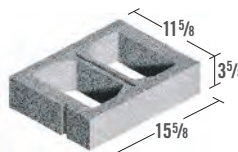

118a 12" x 4" x 16" RESTRICTED BOND BEAM

12" x 4" x 16"
305 x 102 x 406
UNIT WEIGHT: 24
ON PALLET
120 PER CUBE
NON-STOCK

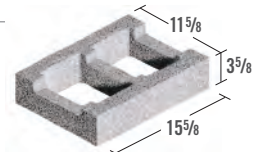

ON PALLET 120 PER CUBE

119 12" x 8" x 8" SASH & END

12" x 8" x 8"
305 x 203 x 203
UNIT WEIGHT: 29
ON PALLET
120 PER CUBE

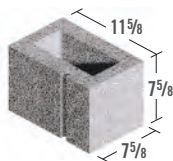

120 12" x 8" x 12" DOUBLE END

12" x 8" x 12"
305 x 203 x 305
UNIT WEIGHT: 41
ON PALLET
80 PER CUBE
NON-STOCK

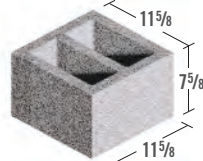

121 12" 45 DEGREE

12" x 8" x 8" x 13"
305 x 203 x 203 x 330
UNIT WEIGHT: 42
ON PALLET
60 PER CUBE
NON-STOCK

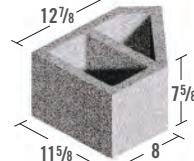

122 12" x 8" x 16" STRETCHER

12" x 8" x 16"
305 x 203 x 406
UNIT WEIGHT: 51
STANDARD CUBE
OR ON PALLET
60 PER CUBE

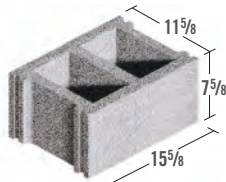

 **RATED 3 HOURS**

124 12" x 8" x 16" DOUBLE END

12" x 8" x 16"
305 x 203 x 406
UNIT WEIGHT: 47
STANDARD CUBE
60 PER CUBE

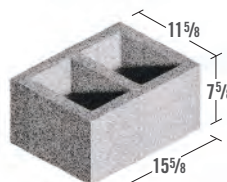

125 12" x 8" x 16" SASH & END

12" x 8" x 16"
305 x 203 x 406
UNIT WEIGHT: 55
ON PALLET
60 PER CUBE

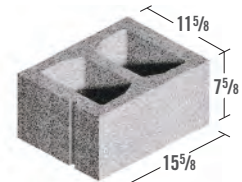

126 12" x 8" x 16" WEEP

12" x 8" x 16"
305 x 203 x 406
UNIT WEIGHT: 47
STANDARD CUBE
72 PER CUBE
NON-STOCK

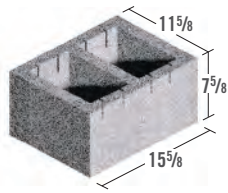

127 12" x 8" x 16" TERMITE

12" x 8" x 16"
305 x 203 x 406
UNIT WEIGHT: 64

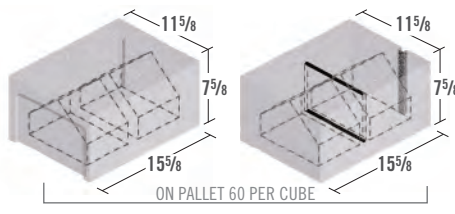

128 12" x 8" x 16" TERMITE SASH & END

12" x 8" x 16"
305 x 203 x 406
UNIT WEIGHT: 66

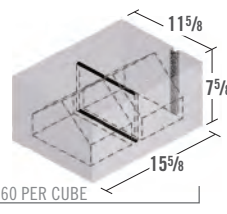

130 12" x 8" x 16" TERMITE OR BOND BEAM

12" x 8" x 16"
305 x 203 x 406
UNIT WEIGHT: 59
ON PALLET
60 PER CUBE
NON-STOCK

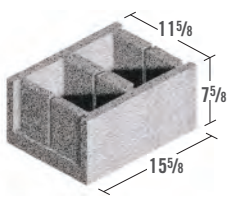

131 12" x 8" x 16" W BOND BEAM

12" x 8" x 16"
305 x 203 x 406
UNIT WEIGHT: 59
ON PALLET
60 PER CUBE

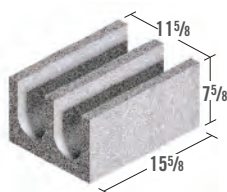

132 12" x 8" x 16" OPEN BOTTOM BOND BEAM

12" x 8" x 16"
305 x 203 x 406
UNIT WEIGHT: 58
ON PALLET
60 PER CUBE
NON-STOCK

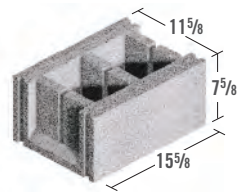

133 12" x 8" x 16" RESTRICTED BOND BEAM

12" x 8" x 16"
305 x 203 x 406
UNIT WEIGHT: 47
ON PALLET
60 PER CUBE

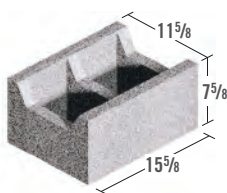

134 12" x 8" x 16" GROUT

12" x 8" x 16"
305 x 203 x 406
UNIT WEIGHT: 39
ON PALLET
60 PER CUBE
NON-STOCK

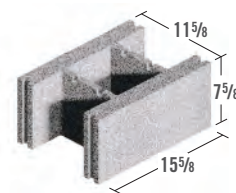

134a 12" x 8" x 16" OPEN END REBAR

12" x 8" x 16"
305 x 203 x 406
UNIT WEIGHT: 46
ON PALLET
60 PER CUBE
NON-STOCK

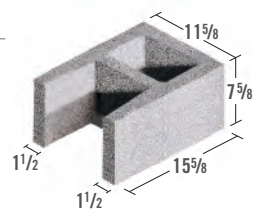

134b 12" x 8" x 16" DOUBLE OPEN END BOND

12" x 8" x 16"
305 x 203 x 406
UNIT WEIGHT: 46
ON PALLET
60 PER CUBE
NON-STOCK

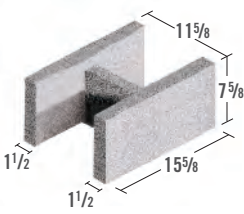

135 12" x 8" x 16" RETURN CORNER

12" x 8" x 16"
305 x 203 x 406
UNIT WEIGHT: 46
ON PALLET
72 PER CUBE

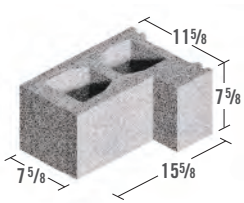

136 12" x 8" x 16" KNOCK-OUT PIPE CHASE

12" x 8" x 16"
305 x 203 x 406
UNIT WEIGHT: 55
ON PALLET
60 PER CUBE

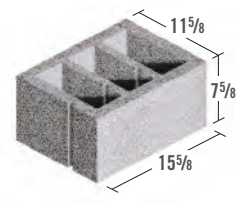

12" BULLNOSE

137 12" x 8" x 8" SINGLE BULLNOSE & END

12" x 8" x 8"
305 x 203 x 203
UNIT WEIGHT: 29
ON PALLET
120 PER CUBE

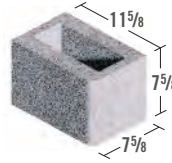

138 12" x 8" x 8" DOUBLE BULLNOSE & END

12" x 8" x 8"
305 x 203 x 203
UNIT WEIGHT: 29
ON PALLET
120 PER CUBE
NON-STOCK

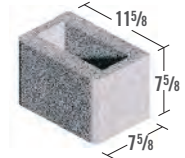

139 12" x 8" x 16" SINGLE BULLNOSE &

12" x 8" x 16"
305 x 203 x 406
UNIT WEIGHT: 57
ON PALLET
60 PER CUBE

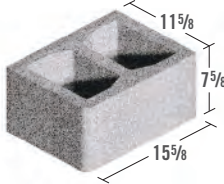

140 12" x 8" x 16" DOUBLE BULLNOSE &

12" x 8" x 16"
305 x 203 x 406
UNIT WEIGHT: 57
ON PALLET
60 PER CUBE
NON-STOCK

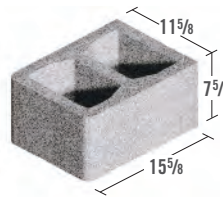

14"

141 14" x 8" x 16" STRETCHER

14" x 8" x 16"
356 x 203 x 406
UNIT WEIGHT: 55
54 PER CUBE

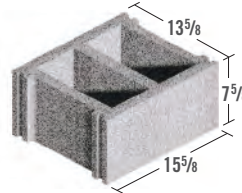

 **RATED 4 HOURS**

142 14" x 8" x 8" SASH & END

14" x 8" x 8"
356 x 203 x 203
UNIT WEIGHT: 33

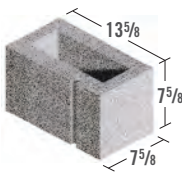

143 14" x 8" x 16" SASH & END

14" x 8" x 16"
356 x 203 x 406
UNIT WEIGHT: 58

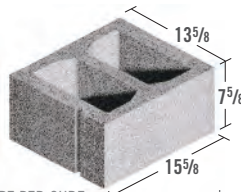

ON PALLET 30 OF EACH SHAPE PER CUBE

 **RATED 4 HOURS**



144 16" x 8" x 16" STRETCHER

16" x 8" x 16"
406 x 203 x 406
UNIT WEIGHT: 57

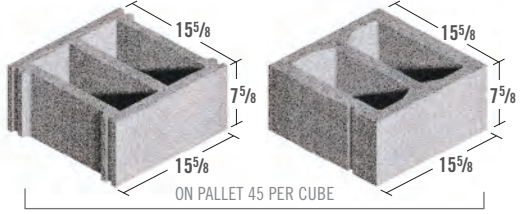

RATED 4 HOURS

145 16" x 8" x 16" SASH & END

16" x 8" x 16"
406 x 203 x 406
UNIT WEIGHT: 63

RATED 4 HOURS

145a 16" x 8" x 8" SASH & END

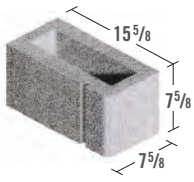

16" x 8" x 8"
406 x 203 x 406
UNIT WEIGHT: 65
90 PER CUBE
NON-STOCK

RATED 4 HOURS

ARCHITECTURAL MASONRY



A10 4" x 4" x 16" SOLID FROGGED ON TOP

4" x 4" x 16"
102 x 102 x 406
UNIT WEIGHT: 15
ON PALLET
216 PER CUBE
NON-STOCK

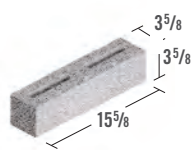

A23 4" x 8" x 16" DOUBLE END

4" x 8" x 16"
102 x 203 x 406
UNIT WEIGHT: 23
NON-STOCK

RATED 1 HOUR

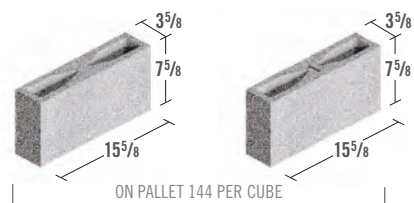

A24 4" x 8" x 16" DOUBLE END BREAKER

4" x 8" x 16"
102 x 203 x 406
UNIT WEIGHT: 24
NON-STOCK

RATED 1 HOUR

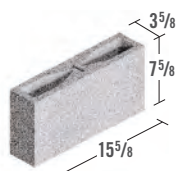

A33 6" x 4" x 16" DOUBLE END

6" x 4" x 16"
152 x 102 x 406
UNIT WEIGHT: 14
NON-STOCK

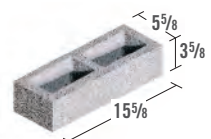

A34 6" x 4" x 16" DOUBLE END BREAKER

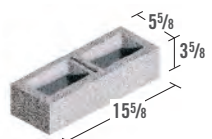

A35 6" x 4" x 16" DOUBLE SASH BREAKER

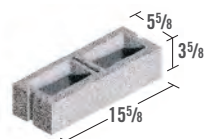

A35a 6" x 4" x 16" SASH & END

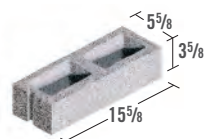

STANDARD CUBE 192 PER CUBE

A43	6" x 8" x 16" DOUBLE END	A44	6" x 8" x 16" DOUBLE END BREAKER	A45	6" x 8" x 16" SASH & END	A46	6" x 8" x 16" DOUBLE SASH BREAKER
------------	---------------------------------	------------	---	------------	-------------------------------------	------------	--

6" x 8" x 16"
152 x 203 x 406
UNIT WEIGHT: 28
NON-STOCK

 **RATED 1 HOUR**

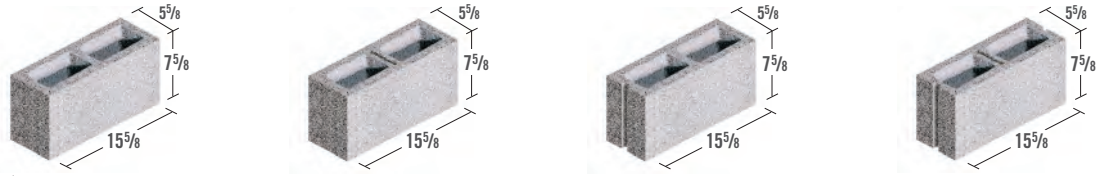

A59	8" x 4" x 16" DOUBLE END*	A60	8" x 4" x 16" DOUBLE END BREAKER*	A61	8" x 4" x 16" SASH & END*	A62	8" x 4" x 16" DOUBLE SASH BREAKER*	A63	8" x 4" x 16" DOUBLE END*
------------	----------------------------------	------------	--	------------	--------------------------------------	------------	---	------------	----------------------------------

8" x 4" x 16"
203 x 102 x 406
UNIT WEIGHT: 17
NON-STOCK

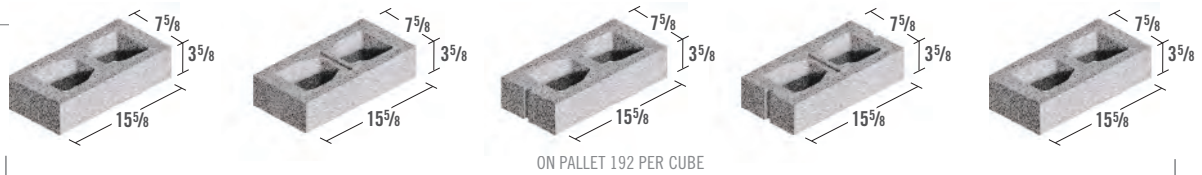

A68a	8" x 8" x 16" DOUBLE END*	A68b	8" x 8" x 16" DOUBLE END BREAKER*	A68c	8" x 8" x 16" SASH & END*	A68d	8" x 8" x 16" DOUBLE SASH BREAKER*	A68e	8" x 8" x 16" DOUBLE END*
-------------	----------------------------------	-------------	--	-------------	--------------------------------------	-------------	---	-------------	----------------------------------

8" x 8" x 16"
203 x 203 x 406
UNIT WEIGHT: 36
NON-STOCK

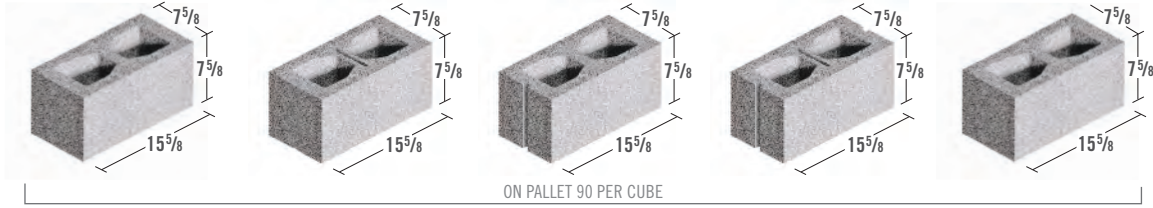

A105	10" x 8" x 16" STRETCHER	A106	10" x 8" x 16" SASH & END BREAKER
-------------	---------------------------------	-------------	--

10" x 8" x 16"
254 x 203 x 406
UNIT WEIGHT: 44
NON-STOCK

 **RATED 3 HOURS**

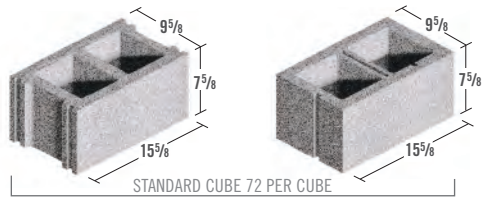

10" x 8" x 16"
254 x 203 x 406
UNIT WEIGHT: 48
NON-STOCK

 **RATED 3 HOURS**

A117a	12" x 4" x 16" DOUBLE END	A117a	12" x 4" x 16" DOUBLE END	A118	12" x 4" x 16" SASH & END BREAKER
--------------	----------------------------------	--------------	----------------------------------	-------------	--

12" x 4" x 16"
305 x 102 x 406
UNIT WEIGHT: 23
NON-STOCK

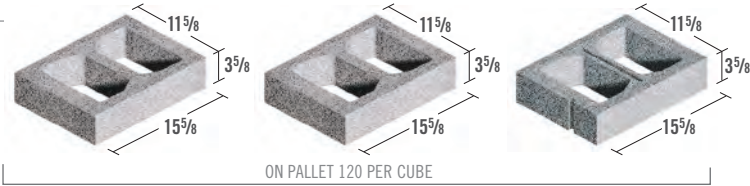

A125a	12" x 8" x 16" DOUBLE END	A125b	12" x 8" x 16" SASH & END BREAKER*	A125c	12" x 8" x 16" DOUBLE END*
--------------	----------------------------------	--------------	---	--------------	-----------------------------------

12" x 8" x 16"
305 x 203 x 406
UNIT WEIGHT: 55
NON-STOCK

ON PALLET 60 PER CUBE

SMOOTH SCORED ARCHITECTURAL	23	4" x 8" x 16" DOUBLE END	24	4" x 8" x 16" DOUBLE END BREAKER
------------------------------------	-----------	---------------------------------	-----------	---

4" x 8" x 16"
102 x 203 x 406
UNIT WEIGHT: 23
NON-STOCK

4" x 8" x 16"
102 x 203 x 406
UNIT WEIGHT: 24
NON-STOCK

ON PALLET 144 PER CUBE

RATED 1 HOUR

43	6" x 8" x 16" DOUBLE END	44	6" x 8" x 16" DOUBLE END BREAKER	45	6" x 8" x 16" SASH & END	46	6" x 8" x 16" DOUBLE SASH BREAKER
-----------	---------------------------------	-----------	---	-----------	-------------------------------------	-----------	--

6" x 8" x 16"
152 x 203 x 406
UNIT WEIGHT: 28
NON-STOCK

STANDARD CUBE 108 PER CUBE

RATED 1 HOUR

68a	8" x 8" x 16" DOUBLE END*	68b	8" x 8" x 16" DOUBLE END BREAKER*	68c	8" x 8" x 16" SASH & END*	68d	8" x 8" x 16" DOUBLE SASH BREAKER*	68e	8" x 8" x 16" DOUBLE END*
------------	----------------------------------	------------	--	------------	--------------------------------------	------------	---	------------	----------------------------------

8" x 8" x 16"
203 x 203 x 406
UNIT WEIGHT: 36
NON-STOCK

ON PALLET 90 PER CUBE

105	10" x 8" x 16" STRETCHER	106	10" x 8" x 16" SASH & END BREAKER
------------	---------------------------------	------------	--

10" x 8" x 16"
254 x 203 x 406
UNIT WEIGHT: 44
NON-STOCK

10" x 8" x 16"
254 x 203 x 406
UNIT WEIGHT: 48
NON-STOCK

STANDARD CUBE 72 PER CUBE

RATED 3 HOURS

125a	12" x 8" x 16" DOUBLE END	125b	12" x 8" x 16" SASH & END BREAKER*	125c	12" x 8" x 16" DOUBLE END*
-------------	-------------------------------------	-------------	--	-------------	--------------------------------------

12" x 8" x 16"
305 x 203 x 406
UNIT WEIGHT: 55
NON-STOCK

ON PALLET 60 PER CUBE

SPLIT FACE 4"

146 **4" x 3" x 8" SOLID SPLIT FACE CONCRETE BRICK**

4" x 3" x 8"
102 x 57 x 203
UNIT WEIGHT: 4
ON PALLET
525 PER CUBE
NON-STOCK

147 **4" x 3" x 8" SOLID CORNER & END SPLIT FACE CONCRETE BRICK**

4" x 3" x 8"
102 x 57 x 203
UNIT WEIGHT: 4
ON PALLET
525 PER CUBE
NON-STOCK

148 **4" x 2" x 16" SOLID SPLIT FACE**

4" x 2" x 16"
102 x 51 x 406
UNIT WEIGHT: 7
ON PALLET
504 PER CUBE
NON-STOCK

149 **4" x 3" x 16" SOLID SPLIT FACE**

4" x 3" x 16"
102 x 76 x 406
UNIT WEIGHT: 12
ON PALLET
288 PER CUBE
NON-STOCK

150 **4" x 4" x 12" SOLID CORNER & END SPLIT FACE**

4" x 4" x 12"
102 x 102 x 305
UNIT WEIGHT: 12
ON PALLET
216 PER CUBE
NON-STOCK

151 **4" x 4" x 16" SOLID SPLIT FACE FROGGED**

4" x 4" x 16"
102 x 102 x 406
UNIT WEIGHT: 17
ON PALLET
216 PER CUBE
NON-STOCK

152 **4" x 8" x 12" SOLID CORNER & END SPLIT FACE**

4" x 8" x 12"
102 x 203 x 305
UNIT WEIGHT: 24
ON PALLET
144 PER CUBE
NON-STOCK

152a **4" x 8" x 16" SOLID L CORNER & END SPLIT FACE**

4" x 8" x 16"
102 x 203 x 406
UNIT WEIGHT: 34
ON PALLET
108 PER CUBE
NON-STOCK

153 **4" x 8" x 16" SOLID SPLIT FACE FROGGED**

4" x 8" x 16"
102 x 203 x 406
UNIT WEIGHT: 34
ON PALLET
108 PER CUBE
NON-STOCK

EVERY 3RD HAS 1 FROG TO SPLIT CORNERS IN THE FIELD

SPLIT FACE 6"

156 6" x 8" x 16" SOLID SPLIT FACE

6" x 8" x 16"
152 x 203 x 406
UNIT WEIGHT: 53
ON PALLET
72 PER CUBE
NON-STOCK

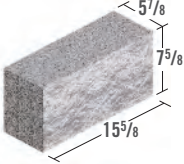

157 6" x 8" x 14" SOLID CORNER & END SPLIT FACE

6" x 8" x 14"
152 x 203 x 356
UNIT WEIGHT: 48
ON PALLET
72 PER CUBE
NON-STOCK

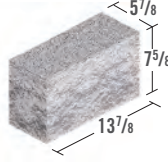

158 6" x 8" x 16" DOUBLE END SPLIT FACE

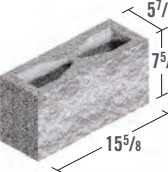
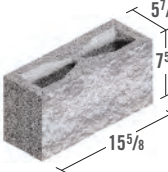
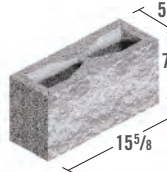
159 6" x 8" x 16" DOUBLE END BREAKER SPLIT FACE

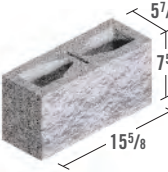

159a 6" x 8" x 16" SASH & END SPLIT FACE

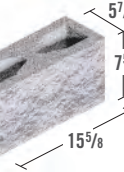

159b 6" x 8" x 16" DOUBLE SASH BREAKER

6" x 8" x 16"
152 x 203 x 406
UNIT WEIGHT: 37
ON PALLET
NON-STOCK



ALL SIX UNITS ON PALLET 96 PER CUBE

SPLIT FACE 8"

160 8" x 4" x 16" SOLID SPLIT FACE

8" x 4" x 16"
203 x 102 x 406
UNIT WEIGHT: 34
ON PALLET
108 PER CUBE
NON-STOCK

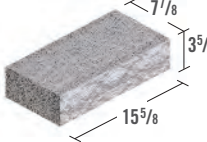

161a 8" x 4" x 16" DOUBLE END SPLIT FACE

8" x 4" x 16"
203 x 102 x 406
UNIT WEIGHT: 19
NON-STOCK

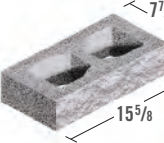

162b 8" x 4" x 16" SASH & END SPLIT FACE

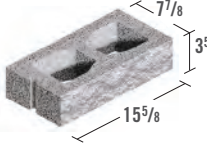

162c 8" x 4" x 16" DOUBLE SASH BREAKER SPLIT FACE

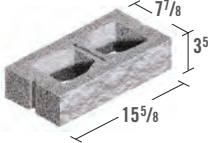

162d 8" x 4" x 16" DOUBLE END BREAKER SPLIT FACE

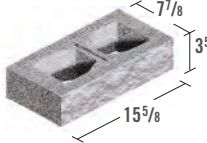

ON PALLET 144 PER CUBE

163 8" x 4" x 16" CORNER & END SPLIT FACE

8" x 4" x 16"
203 x 102 x 406
UNIT WEIGHT: 19
ON PALLET
120 PER CUBE
NON-STOCK

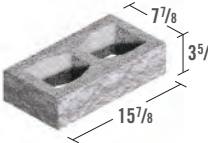

164 8" x 4" x 16" SASH & END SPLIT FACE

8" x 8" x 8"
203 x 203 x 203
UNIT WEIGHT: 22
ON PALLET
144 PER CUBE

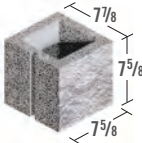

167a	8" x 8" x 16" DOUBLE END SPLIT FACE	167b	8" x 8" x 16" SASH & END SPLIT FACE	167c	8" x 8" x 16" DOUBLE SASH BREAKER SPLIT FACE	167d	8" x 8" x 16" DOUBLE END BREAKER SPLIT FACE
-------------	--	-------------	--	-------------	---	-------------	--

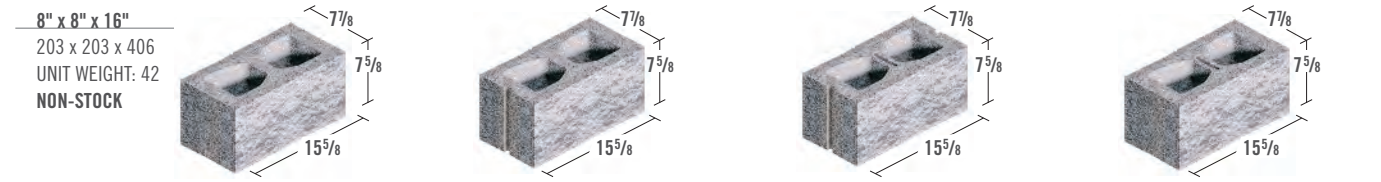

169	8" x 8" x 16" CORNER & END SPLIT FACE	170	8" x 8" x 16" RESTRICTED BOND BEAM OPEN BOTTOM SPLIT FACE	170a	8" x 8" x 16" U BOND BEAM SPLIT FACE
------------	--	------------	--	-------------	---

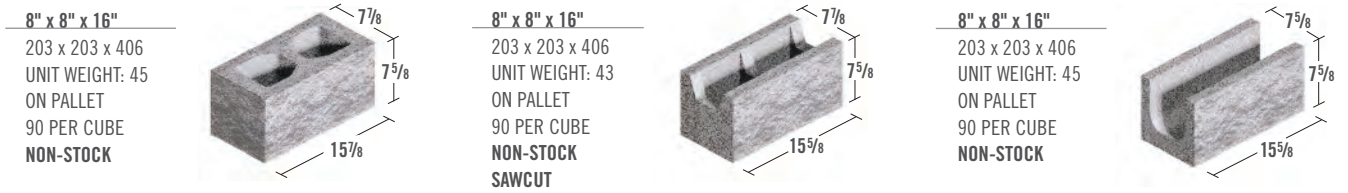

173	8" x 8" x 16" TERMITE OR BOND BEAM SPLIT FACE	174	8" x 8" x 16" TERMITE SPLIT FACE	175	8" x 8" x 16" TERMITE SASH & END BREAKER SPLIT FACE
------------	--	------------	---	------------	--

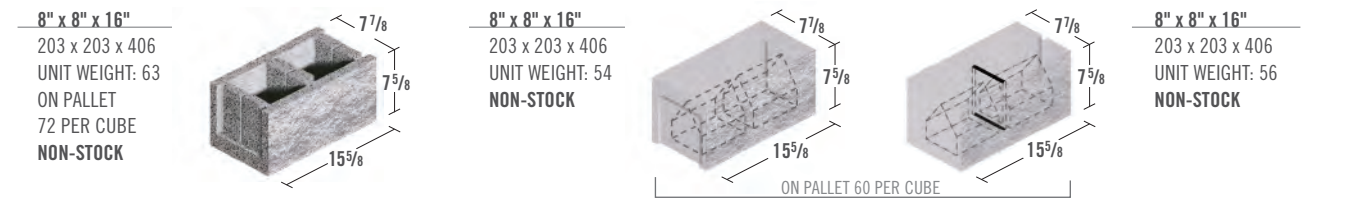

175a	8" x 8" x 16" 45 DEGREE HC SPLIT FACE	175b	8" x 8" x 16" 45 DEGREE HC SINGLE SCORE SPLIT FACE
-------------	--	-------------	---

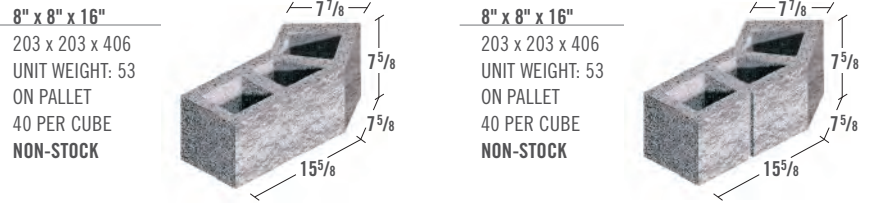

SPLIT FACE 10"

178 10" x 8" x 16" STRETCHER SPLIT FACE

178a 10" x 8" x 16" SASH & END BREAKER SPLIT FACE

10" x 8" x 16"
254 x 203 x 406
UNIT WEIGHT: 54
NON-STOCK

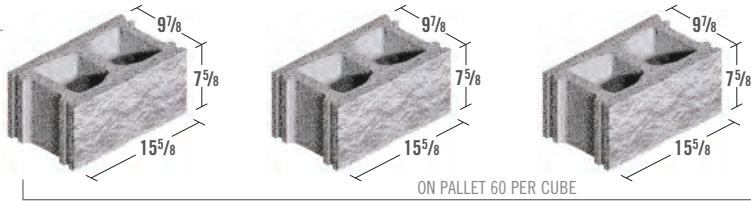

10" x 8" x 16"
254 x 203 x 406
UNIT WEIGHT: 56
NON-STOCK

180 10" x 8" x 16" TERMITE OR BOND BEAM SPLIT FACE

181 10" x 8" x 16" OPEN BOTTOM BOND BEAM SPLIT FACE

10" x 8" x 16"
254 x 203 x 406
UNIT WEIGHT: 60
ON PALLET
60 PER CUBE
NON-STOCK

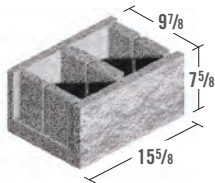

10" x 8" x 16"
254 x 203 x 406
UNIT WEIGHT: 53
ON PALLET
72 PER CUBE
NON-STOCK

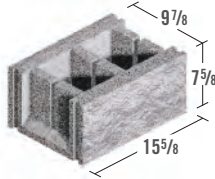

SPLIT FACE 12"

182 12" x 4" x 16" SOLID SPLIT FACE

12" x 4" x 16"
305 x 102 x 406
UNIT WEIGHT: 51
ON PALLET
60 PER CUBE
NON-STOCK

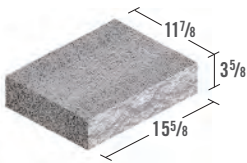

183 12" x 4" x 16" DOUBLE END SPLIT FACE

184 12" x 4" x 16" SASH & END BREAKER SPLIT FACE

185 12" x 8" x 8" SASH & END SPLIT FACE

12" x 4" x 16"
305 x 102 x 406
UNIT WEIGHT: 29
NON-STOCK

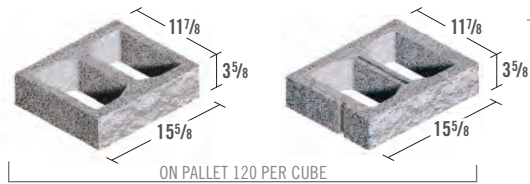

12" x 4" x 16"
305 x 102 x 406
UNIT WEIGHT: 30
NON-STOCK

12" x 8" x 8"
305 x 203 x 203
UNIT WEIGHT: 31
ON PALLET
120 PER CUBE
NON-STOCK

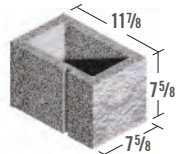

186 12" x 8" x 16" STRETCHER SPLIT FACE

12" x 8" x 16"
305 x 203 x 406
UNIT WEIGHT: 58
NON-STOCK

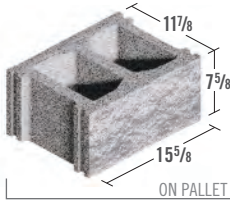

187 12" x 8" x 16" SASH & END BREAKER SPLIT FACE

12" x 8" x 16"
305 x 203 x 406
UNIT WEIGHT: 60
NON-STOCK

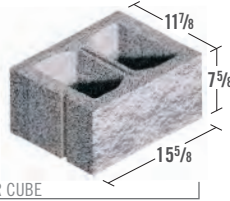

188 12" x 8" x 16" TERMITE OR BOND BEAM SPLIT FACE

12" x 8" x 16"
305 x 203 x 406
UNIT WEIGHT: 63
ON PALLET
60 PER CUBE
NON-STOCK

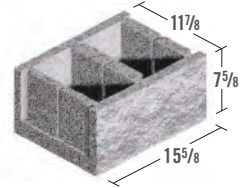

188b 12" x 8" x 16" REST. BOND BEAM SPLIT FACE

12" x 8" x 16"
305 x 203 x 406
UNIT WEIGHT: 63
ON PALLET
60 PER CUBE
NON-STOCK

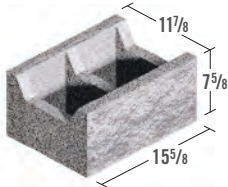

SCORED SPLIT FACE

191 8" x 4" x 16" DOUBLE END SINGLE SCORE SPLIT FACE

8" x 4" x 16"
203 x 102 x 406
UNIT WEIGHT: 19
NON-STOCK

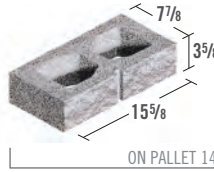

192 8" x 4" x 16" SASH & END BREAKER SINGLE SCORE SPLIT FACE

8" x 4" x 16"
203 x 102 x 406
UNIT WEIGHT: 20
NON-STOCK

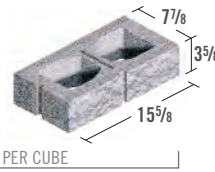

193 8" x 4" x 16" CORNER & END SINGLE SCORE SPLIT FACE

8" x 4" x 16"
203 x 102 x 406
UNIT WEIGHT: 19
ON PALLET
120 PER CUBE
NON-STOCK

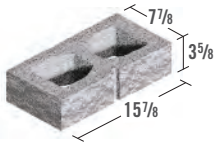

194a 8" x 8" x 16" DOUBLE END SINGLE SCORE SPLIT FACE

8" x 8" x 16"
203 x 203 x 406
UNIT WEIGHT: 42
NON-STOCK

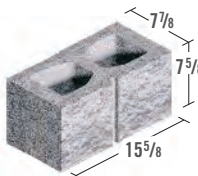

194b 8" x 8" x 16" SASH & END SINGLE SCORE SPLIT FACE

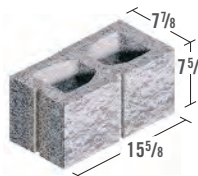

194c 8" x 8" x 16" DOUBLE SASH SINGLE SCORE BREAKER SPLIT FACE

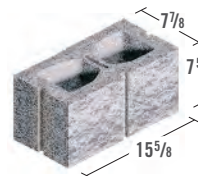

194d 8" x 8" x 16" DOUBLE END BREAKER SINGLE SCORE SPLIT FACE

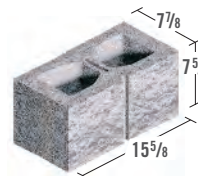

ON PALLET 90 PER CUBE

196 8" x 8" x 16" CORNER & END SINGLE SCORE SPLIT FACE

8" x 8" x 16"
203 x 203 x 406
UNIT WEIGHT: 45
ON PALLET
90 PER CUBE
NON-STOCK

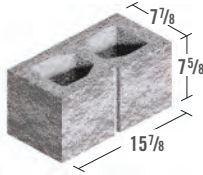

197 12" x 4" x 16" DOUBLE END SINGLE SCORE

12" x 4" x 16"
305 x 102 x 406
UNIT WEIGHT: 29
NON-STOCK

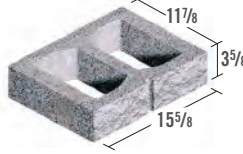

198 12" x 4" x 16" SASH & END BREAKER SINGLE SCORE SPLIT FACE

12" x 4" x 16"
305 x 102 x 406
UNIT WEIGHT: 30
NON-STOCK

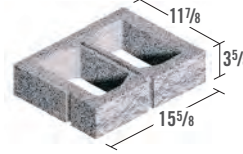

ON PALLET 120 PER CUBE

199 12" x 8" x 16" STRETCHER SINGLE SCORE SPLIT FACE

12" x 8" x 16"
305 x 203 x 406
UNIT WEIGHT: 58
NON-STOCK

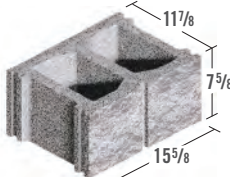

200 12" x 8" x 16" SASH & END BREAKER SINGLE SCORE SPLIT FACE

12" x 8" x 16"
305 x 203 x 406
UNIT WEIGHT: 60
NON-STOCK

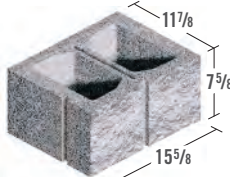

ON PALLET 60 PER CUBE

DEEP 4 FLUTE SPLIT FACE

219 4" x 8" x 12" SOLID CORNER & END DEEP 4 FLUTE SPLIT FACE

4" x 8" x 12"
102 x 203 x 305
UNIT WEIGHT: 24
ON PALLET
96 PER CUBE
NON-STOCK

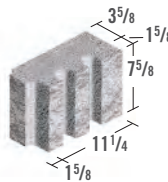

220 4" x 8" x 16" SOLID DOUBLE END DEEP 4 FLUTE SPLIT FACE

4" x 8" x 16"
102 x 203 x 406
UNIT WEIGHT: 30
ON PALLET
108 PER CUBE
NON-STOCK

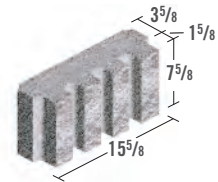

8 FLUTE SPLIT FACE

240 4" x 8" x 16" SOLID DOUBLE END 8 FLUTE SPLIT FACE

4" x 8" x 16"
102 x 203 x 406
UNIT WEIGHT: 30
ON PALLET
144 PER CUBE
NON-STOCK

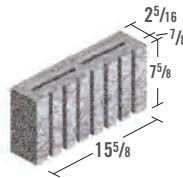

241 4" x 8" x 16" SOLID 45 DEGREE CORNER & END 8 FLUTE SPLIT FACE

4" x 8" x 16"
102 x 203 x 406
UNIT WEIGHT: 26
ON PALLET
144 PER CUBE
NON-STOCK

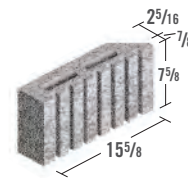

242 8" x 8" x 16" 45 DEGREE CORNER & END 8 FLUTE SPLIT FACE

8" x 8" x 16"
203 x 203 x 406
UNIT WEIGHT: 40
ON PALLET
75 PER CUBE
NON-STOCK

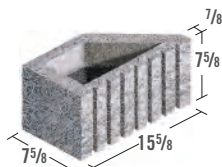

243 8" x 8" x 16" STRETCHER 8 FLUTE SPLIT FACE

8" x 8" x 16"
203 x 203 x 406
UNIT WEIGHT: 43
NON-STOCK

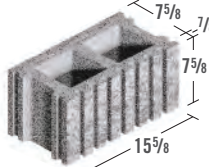

244 8" x 8" x 16" SASH & END BREAKER 8 FLUTE SPLIT FACE

8" x 8" x 16"
203 x 203 x 406
UNIT WEIGHT: 44
NON-STOCK

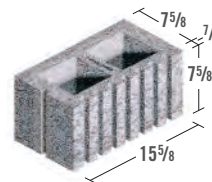

245

12" x 8" x 16" STRETCHER
8 FLUTE SPLIT FACE

12" x 8" x 16"
305 x 203 x 406
UNIT WEIGHT: 61
NON-STOCK

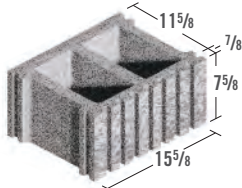

246

12" x 8" x 16" SASH & END BREAKER
8 FLUTE SPLIT FACE

12" x 8" x 16"
305 x 203 x 406
UNIT WEIGHT: 62
NON-STOCK

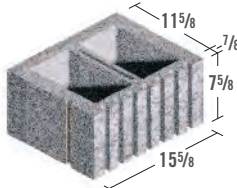

ON PALLET 54 PER CUBE

SOLID CHAMFERED SILLS

261

4" x 8" x 16" SOLID CHAMFERED SILL

4" x 8" x 16"
102 x 203 x 406
UNIT WEIGHT: 28
ON PALLET
108 PER CUBE
NON-STOCK

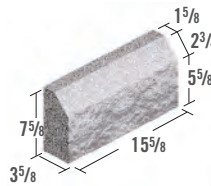

263

6" x 8" x 16" SOLID CHAMFERED SILL

6" x 8" x 16"
152 x 203 x 406
UNIT WEIGHT: 47
ON PALLET
72 PER CUBE
NON-STOCK

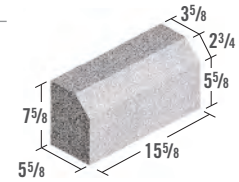

264

8" x 8" x 16" SOLID CHAMFERED SILL

8" x 8" x 16"
203 x 203 x 406
UNIT WEIGHT: 64
ON PALLET
54 PER CUBE
NON-STOCK

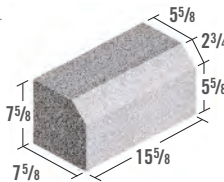

266

4" x 8" x 16" SOLID CHAMFERED SILL
SPLIT FACE

4" x 8" x 16"
102 x 203 x 406
UNIT WEIGHT: 29
ON PALLET
108 PER CUBE
NON-STOCK

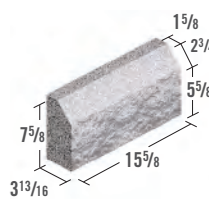

268

6" x 8" x 16" SOLID CHAMFERED SILL
SPLIT FACE

6" x 8" x 16"
152 x 203 x 406
UNIT WEIGHT: 48
ON PALLET
72 PER CUBE
NON-STOCK

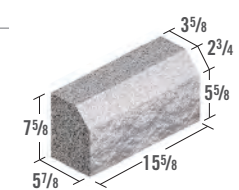

269

8" x 8" x 16" SOLID CHAMFERED SILL
SPLIT FACE

8" x 8" x 16"
203 x 203 x 406
UNIT WEIGHT: 66
ON PALLET
54 PER CUBE
NON-STOCK

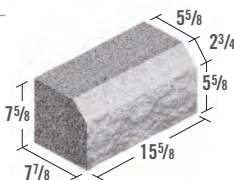

COLOSSALBLOK™

270

4" x 12" x 16" SOLID

4" x 12" x 16"
102 x 305 x 406
UNIT WEIGHT: 50
ON PALLET
72 PER CUBE
NON-STOCK

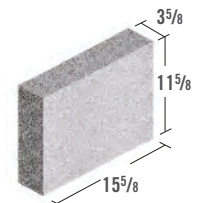

272

4" x 8" x 24" SOLID

4" x 8" x 24"
102 x 203 x 610
UNIT WEIGHT: 50
ON PALLET
72 PER CUBE
NON-STOCK

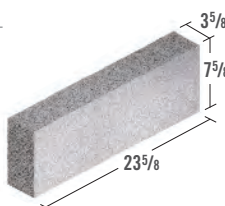

273

4" x 12" x 24" SOLID

4" x 12" x 24"
102 x 305 x 610
UNIT WEIGHT: 80
ON PALLET
48 PER CUBE
NON-STOCK

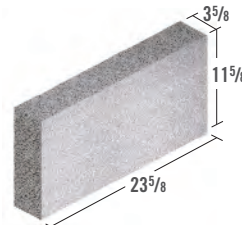

277

4" x 8" x 24" SOLID SPLIT FACE

4" x 8" x 24"
102 x 203 x 610
UNIT WEIGHT: 53
ON PALLET
72 PER CUBE
NON-STOCK

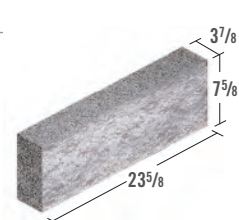

SoundBloX

288 8" x 8" x 16" TYPE RSC/RF (8") SOUNDBLOX

8" x 8" x 16"
203 x 203 x 406
UNIT WEIGHT: 43
ON PALLET
90 PER CUBE
NON-STOCK

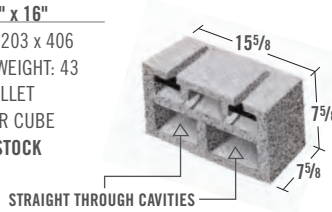

289 10" x 8" x 16" TYPE RSC/RF (10") SOUNDBLOX

10" x 8" x 16"
254 x 203 x 406
UNIT WEIGHT: 51
ON PALLET
72 PER CUBE
NON-STOCK

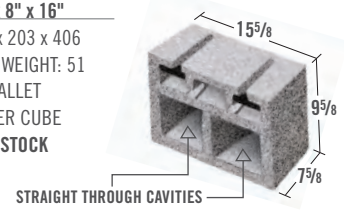

290 12" x 8" x 16" TYPE RSC/RF (12") SOUNDBLOX

12" x 8" x 16"
305 x 203 x 406
UNIT WEIGHT: 59
ON PALLET
60 PER CUBE
NON-STOCK

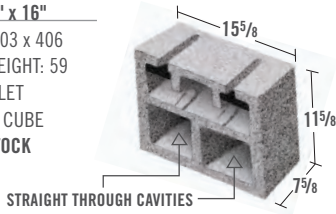

291 12" x 8" x 16" TYPE RSC/RF4 (12") SOUNDBLOX

12" x 8" x 16"
305 x 203 x 406
UNIT WEIGHT: 59
ON PALLET
60 PER CUBE
NON-STOCK

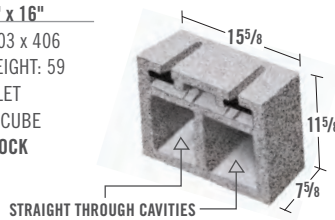

Spec-Brik Hi R®

297 12" x 4" x 16" Hi R SMOOTH*

12" x 4" x 16"
305 x 102 x 406
UNIT WEIGHT: 22
ON PALLET
120 PER CUBE
NON-STOCK

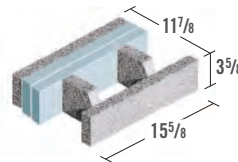

298 12" x 4" x 16" Hi R SPLIT FACE*

12" x 4" x 16"
305 x 102 x 406
UNIT WEIGHT: 23
ON PALLET
120 PER CUBE
NON-STOCK

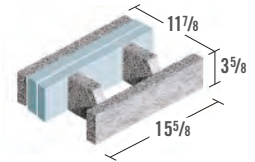

299 12" x 8" x 16" Hi R SMOOTH*

12" x 8" x 16"
305 x 203 x 406
UNIT WEIGHT: 43
ON PALLET
60 PER CUBE
NON-STOCK

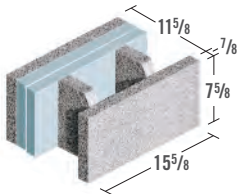

300 12" x 8" x 16" Hi R SPLIT FACE*

12" x 8" x 16"
305 x 102 x 406
UNIT WEIGHT: 44
ON PALLET
60 PER CUBE
NON-STOCK

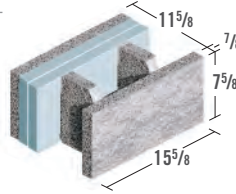

CORNER DETAILS ▾

A 4" WALL USING 4" x 8" x 12" SOLID CORNER & END SPLIT FACE

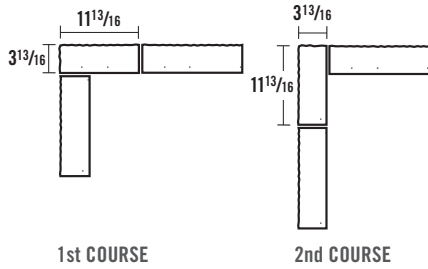

B 4" WALL USING 4" x 8" x 16" FULL RETURN L CORNER

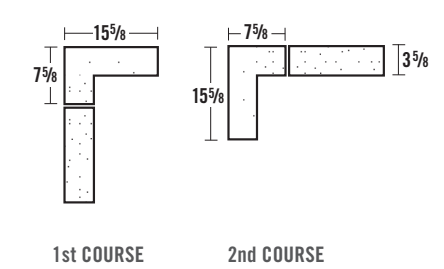

Ba 4" WALL USING 4" x 8" x 16" FULL RETURN L CORNER SPLIT FACE

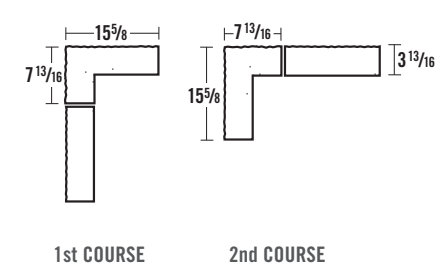

C 4" WALL USING 4" x 8" x 12" CORNER & END DEEP 4 FLUTE SPLIT FACE

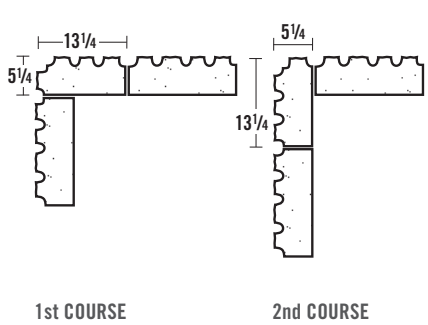

D 4" WALL USING 4" x 8" x 16" 45° CORNER & END 8 FLUTE SPLIT FACE

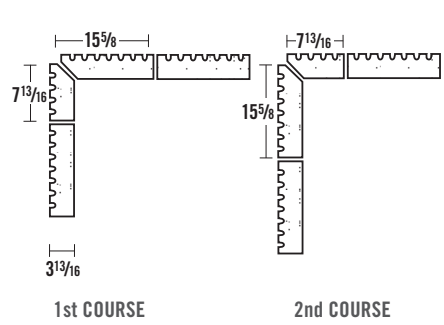

E 6" WALL USING 6" x 8" x 14" DOUBLE END

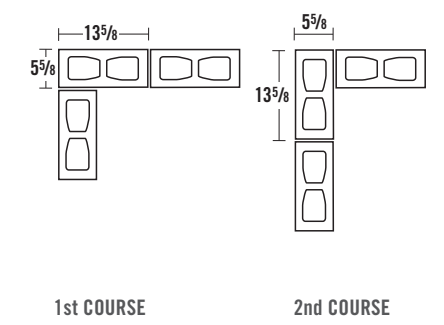

F 8" WALL USING 4" x 8" x 12" SOLID CORNER & END SPLIT FACE

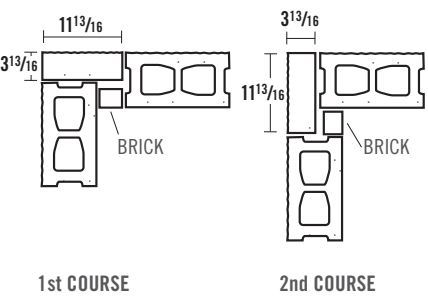

G 8" WALL USING 8" x 8" x 16" CORNER & END SPLIT FACE

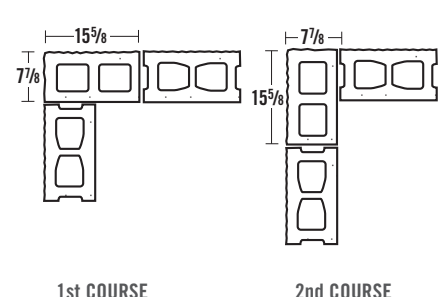

I 8" WALL USING 4" x 8" x 12" CORNER & END DEEP 4 FLUTE SPLIT FACE

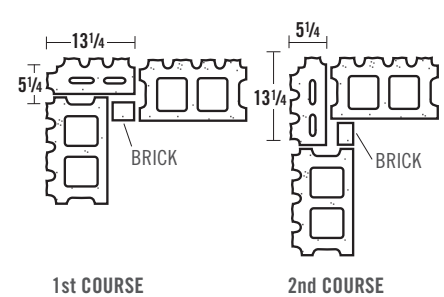

J 8" WALL USING 8" x 8" x 16" 45° CORNER & END 8 FLUTE SPLIT FACE

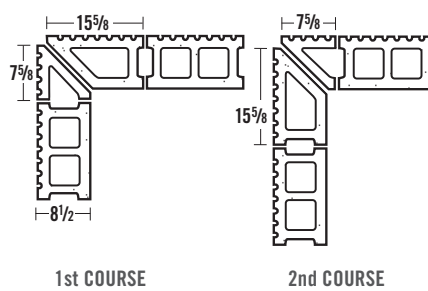

K 10" WALL USING 10" x 8" x 16" RETURN CORNER

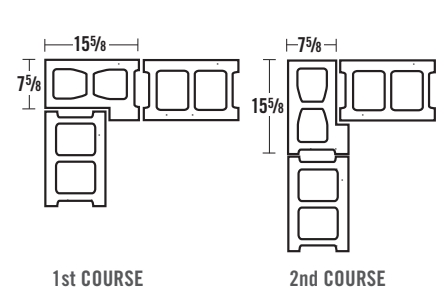

L 12" WALL USING 4" x 8" x 12" SOLID CORNER SPLIT FACE

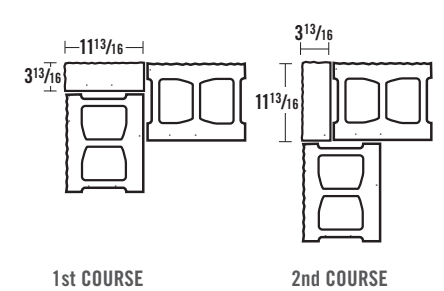

CORNER DETAILS (CONTINUED) ▾

M 12" WALL USING 8" x 8" x 16" CORNER & END SPLIT FACE

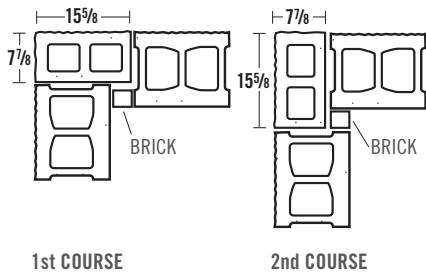

N 12" WALL USING 4" x 8" x 12" CORNER & END DEEP 4 FLUTE SPLIT FACE

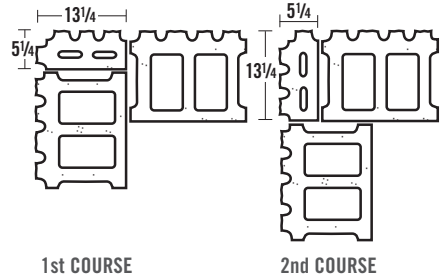

O 12" WALL USING 12" x 8" x 16" RETURN CORNER

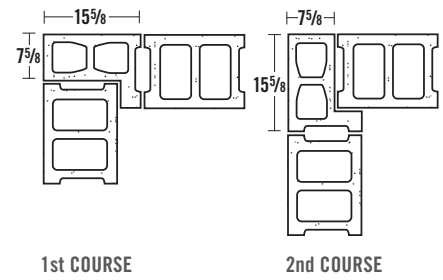

P 14" WALL USING 6" x 8" x 14" DOUBLE END

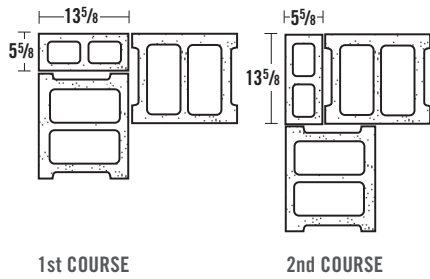

Q 16" WALL USING 8" x 8" x 16" DOUBLE END

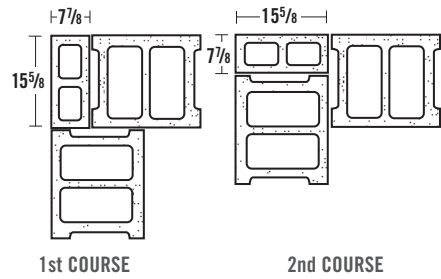

R 4" WALL USING 4" x 12" x 16" SOLID CORNER & END SPLIT FACE OR SAND BLASTED

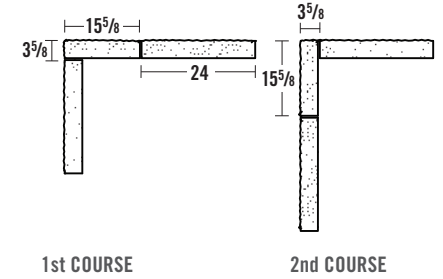

PIER DETAILS ▾

8" UNITS

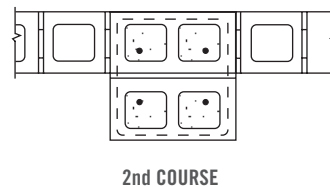
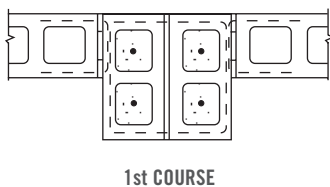

8" & 12" UNITS

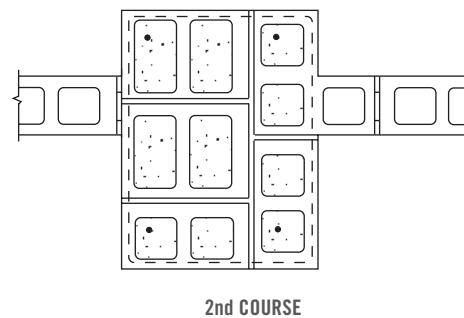
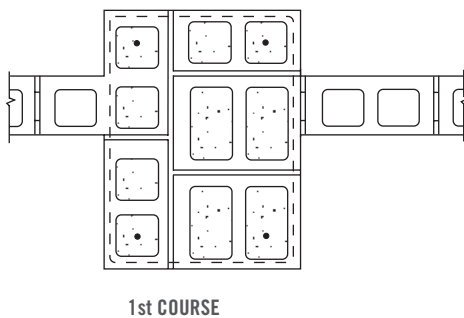

LENGTH OF CONCRETE MASONRY WALLS BY STRETCHERS

NO. OF STRETCHERS	WALL LENGTH
1	1'4"
1.5	2'0"
2	2'8"
2.5	3'4"
3	4'0"
3.5	4'8"
4	5'4"
4.5	6'0"
5	6'8"
5.5	7'4"
6	8'0"
6.5	8'8"
7	9'4"
7.5	10'0"
8	10'8"
8.5	11'4"
9	12'0"
9.5	12'8"
10	13'4"
10.5	14'0"
11	14'8"
11.5	15'4"
12	16'0"
12.5	16'8"
13	17'4"
13.5	18'0"
14	18'8"
14.5	19'4"
15	20'0"
20	26'8"

* Based on concrete blocks 15⁵/₈ in. long and half units 7⁵/₈ in. long, with ³/₈ in. thick head joints. Actual lengths of finished walls are ³/₈ in. less than the modular dimensions shown in this table.



HEIGHT OF CONCRETE MASONRY WALLS BY COURSES

NO. OF COURSES	WALL HEIGHT					
	3/8" BED JOINT		7/16" BED JOINT		1/2" BED JOINT	
	8" BLOCK	4" BLOCK	8" block	4" block	8" block	4" block
1	8"	4"	8 ¹ / ₁₆ "	4 ¹ / ₁₆ "	8 ¹ / ₈ "	4 ¹ / ₈ "
2	1'4"	8"	1'4 ¹ / ₈ "	8 ¹ / ₈ "	1'4 ¹ / ₄ "	8 ¹ / ₄ "
3	2'0"	1'0"	2' ³ / ₁₆ "	1' ³ / ₁₆ "	2' ³ / ₈ "	1' ³ / ₈ "
4	2'8"	1'4"	2'8 ¹ / ₄ "	1'4 ¹ / ₄ "	2'8 ¹ / ₂ "	1'4 ¹ / ₂ "
5	3'4"	1'8"	3'4 ⁵ / ₁₆ "	1'8 ⁵ / ₁₆ "	3'4 ⁵ / ₈ "	1'8 ⁵ / ₈ "
6	4'0"	2'0"	4' ³ / ₈ "	2' ³ / ₈ "	4' ³ / ₄ "	2' ³ / ₄ "
7	4'8"	2'4"	4'8 ⁷ / ₁₆ "	2'4 ⁷ / ₁₆ "	4'8 ⁷ / ₈ "	2'4 ⁷ / ₈ "
8	5'4"	2'8"	5'4 ¹ / ₂ "	2'8 ¹ / ₂ "	5'5"	2'9"
9	6'0"	3'0"	6' ⁹ / ₁₆ "	3' ⁹ / ₁₆ "	6'1 ¹ / ₈ "	3'1 ¹ / ₈ "
10	6'8"	3'4"	6'8 ⁵ / ₈ "	3'4 ⁵ / ₈ "	6'9 ¹ / ₄ "	3'5 ¹ / ₄ "
15	10'0"	5'0"	10' ¹⁵ / ₁₆ "	5' ¹⁵ / ₁₆ "	10'1 ⁷ / ₈ "	5'1 ⁷ / ₈ "
20	13'4"	6'8"	13'5 ¹ / ₄ "	6'9 ¹ / ₄ "	13'6 ¹ / ₂ "	6'10 ¹ / ₂ "
25	16'8"	8'4"	16'9 ⁹ / ₁₆ "	8'5 ⁹ / ₁₆ "	16'11 ¹ / ₈ "	8'7 ¹ / ₈ "
30	20'0"	10'0"	20'1 ⁷ / ₈ "	10'1 ⁷ / ₈ "	20'3 ³ / ₄ "	10'3 ³ / ₄ "
35	23'4"	11'8"	23'6 ³ / ₁₆ "	11'10 ³ / ₁₆ "	23'8 ³ / ₈ "	12' ³ / ₈ "
40	26'8"	13'4"	26'10 ¹ / ₂ "	13'6 ¹ / ₂ "	27'1"	13'9"
45	30'0"	15'0"	30'2 ¹³ / ₁₆ "	15'2 ¹³ / ₁₆ "	30'5 ⁵ / ₈ "	15'5 ⁵ / ₈ "
50	33'4"	16'8"	33'7 ¹ / ₈ "	16'11 ¹ / ₈ "	33'10 ¹ / ₄ "	17'2 ¹ / ₄ "

ESTIMATING GUIDES ▾ The figures shown below are intended for “rule of thumb” use only

UNIT QUANTITIES

Standard Block (8x8x16)
1.13 block per square foot of wall area

Concrete Brick
7.0 concrete brick per square foot of wall area

Half-High Block (4x4x16 or 8x4x16)
2.26 block per square foot of wall area

MORTAR QUANTITIES

Per 1000 Units	Masonry Cement Bags	Sand Tons
4" and 6" Regular Block	20	2
8", 10", and 12" Regular Block	25	2½
Concrete Brick	8	1¼

APPROXIMATE VOLUME REQUIRED TO FILL CORE VOIDS IN BLOCK

6 x 8 x 16	2 core	0.17 cu.ft./block
6 x 8 x 16	3 core	0.15 cu.ft./block
8 x 8 x 16	2 core	0.25 cu.ft./block
8 x 8 x 16	3 core	0.22 cu.ft./block
10 x 8 x 16	2 core	0.33 cu.ft./block
10 x 8 x 16	3 core	0.29 cu.ft./block
12 x 8 x 16	2 core	0.39 cu.ft./block
12 x 8 x 16	3 core	0.34 cu.ft./block

Example: 5000 - 8" - 2 core H.C. to be filled
 $5000 \times 0.25 = 1250$ cu. ft. ÷ 27 cu. ft. per yard
 = 46.30 yards

APPROXIMATE QUANTITIES OF CONCRETE REQUIRED TO FILL LINTELS AND BOND BEAMS ▾

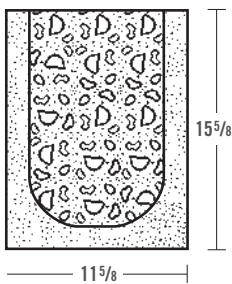

.74 cu.ft. concrete per lin. ft.

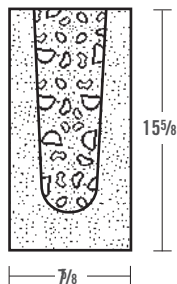

.46 cu.ft. concrete per lin. ft.

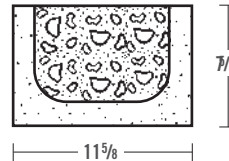

.37 cu.ft. concrete per lin. ft.

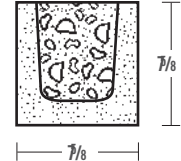

.22 cu.ft. concrete per lin. ft.

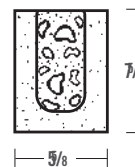

.173 cu.ft. concrete per lin. ft.



.08 cu.ft. concrete per lin. ft.

CLEANING CONCRETE MASONRY

Oberfields. **recommended** procedure for cleaning concrete masonry surfaces.

NEW CONSTRUCTION

In order to reduce the amount of cleaning required at the completion of a building, walls should be cleaned each day. Mortar droppings should be allowed to harden slightly, then scraped off with a trowel or wood scraper. A small piece of broken block is also effective, followed by brushing with a stiff bristle or stainless steel wire brush (never use a steel wire brush).

Good masonry practices will minimize the amount of final cleaning significantly. Turning scaffolding boards at the end of the day and using sand or straw at the base of the wall will eliminate stains that are very difficult to remove later. Another important step is to cover the top of unfinished walls at the end of each day. This will prevent water from entering the cavities and will help prevent efflorescence. The plastic or tarps should drape at least two feet down each side of the wall.

Final cleaning will be easier if it occurs approximately one week after completion of walls (newly constructed walls must set 4 or 5 days to allow the mortar to harden prior to cleaning).

Never use high pressure cleaning! The use of high pressure power washers will most certainly alter the appearance of a concrete masonry wall and could cause unreparable damage to the building. A pressure washer with a maximum of 200 psi and a wide flare nozzle held 12 to 18 inches from the surface will give excellent results on most projects. Pre-wetting walls is a necessary first step. Work in sections from top down for best results.

CHEMICAL CLEANING

If good masonry practices are followed, chemical cleaning will seldom be necessary. If required, consult project specifications or call OBERFIELDS LLC for product recommendations.

Follow mix solutions and directions of manufacturer. Always pre-wet surfaces prior to application of any cleaning solution.

Oil stains, grease, graffiti or efflorescence removal, refer to N.C.M.A. Tek Notes 8.1, 8.2, 8.3, and 8.4. Copies of these teks are available from OBERFIELDS LLC, oberfields.com, or The National Concrete Masonry Association.

WATER CONTROL TECHNOLOGY (WCT) ▾

Why try to improve on one of the most trusted construction materials available? Water Control Technology (WCT) is based on preserving the superior performance characteristics of concrete masonry units while adding features that improve the ability of masonry wall assemblies to resist moisture penetration. Subtle changes were made to the top surface of each WCT units web to discourage water from crossing to the interior face shell. Corners and ends can use the WCT drainage zones without compromising aesthetics or performance. This innovation is fully compliant with ASTM C 90 and is a standard feature on all architectural masonry units produced by OBERFIELDS.

- WCT units feature integral drainage zones that direct moisture to the wall's drainage system.
- No special installation techniques required—cost effectiveness is assured.
- WCT units are suitable for corners and ends for a complete system.
- All units have integral water repellent in their mix design.
- WCT units meet or exceed ASTM C 90.
- Perfect for both single or multi-wythe walls.
- Offered in a wide variety of shapes and sizes.

TESTING

WCT units were spray bar tested with no mortar (just gaps) alongside a traditional block design with a water flow rate equivalent to 180" of rain per hour for a half hour and then at a rate of 30" of rain for an additional 24 hours.

RESULT: the traditional block began to show moisture penetration to the interior surface after 11 seconds. The WCT block completed the 24 hour test without any evident moisture penetration to the interior surface of the wall.



Understanding The Masonry Process

Smooth Face Architectural Concrete Masonry

“Smooth Face Architectural Concrete Masonry” is the designation used when a manufacturer produces a regular concrete block in a colored mix design. The only visual difference between Smooth Face Architectural Concrete Masonry and regular block...is the color.

For architects to achieve their design objective, it is important to understand the limitations of Smooth Face Architectural Concrete Masonry. The purpose of this page is to provide insight on the production process and field handling which collectively influence the finish and appearance of these block walls.

At the Block Plant

TEXTURE

Smooth Face Architectural Concrete Block is produced using the same molds and production process as a regular block. The texture and aris of Smooth Face Architectural Block are very similar to a regular concrete block. Smooth Face Architectural Block produced from white aggregate tend to have even rougher edges and irregular texture due to the physical characteristics of most white aggregates.

COLOR CONSISTENCY

Concrete products use synthetic iron oxides to achieve color. The colored iron oxides are batched into the concrete mix where they are bound into the cement paste. The pigmented cement paste then acts as a binding agent for the aggregates in the concrete product.

When concrete block are produced, this pigmented concrete mix is compacted in the mold under high pressure. This pressure forces the cement paste to the surface of the block. When you look at a Smooth Face Architectural Block, the color you see is predominately the cement paste. The concentration of cement paste that is forced to the surface varies block per block causing the overall color of the Smooth Face Block to change.

This is not true with Split Face, Ground Face or Sandblasted units. Split Face Block are molded together and split apart after they are removed from the kiln. The concentration of cement paste forms on the opposite side of the finished surface. The cement paste on the surface of Sandblasted and Ground Face Block is either blasted or ground off during the manufacturing process. Both Sandblasted and Ground Face rely on the exposed aggregate matrix of the concrete to achieve their appearance.

To illustrate this point, view the Split, Sandblasted or Ground Face of an Architectural Concrete Masonry wall during construction. Next, look at the opposite side of that very same wall. The surface that removes the cement paste and exposes the aggregate matrix (split, sandblasted or ground) will show only a slight range of color. The surface with the cement paste remaining (smooth face) will show a wide noticeable color range.

Concrete block are cured in large kilns in a block plant. The goal of curing is hydration of the cement and is typically accomplished by elevating the temperature and moisture in the kiln. Temperature and moisture significantly affect the color of cement paste. Because the temperature and moisture vary within the kiln, the color of the cement paste will vary throughout the block in the kiln. Split Face, Ground Face or Sandblasted, whose finished surface do not rely on the surface cement paste are not affected. Smooth Face Block is significantly affected.

Handling At The Jobsite

CHIPPING

ASTM C-90 Standard Specification for “Load Bearing Concrete Masonry Units” recognizes that all concrete block projects experience chipping of the units from delivery and handling at the jobsite. “Minor cracks incidental to the usual method of manufacturing or minor chipping resulting from customary methods of handling in shipment and delivery are not grounds for rejection.” The rough texture of Split Face and Sandblasted Block mask minor chips and allow the

mason contractor to fill in a minor chip while the mortar joints are tooled. Small chips and rough edges are very difficult and often not possible to blend into the Smooth Face Block due to its lack of texture.

SCRATCHING

The concentrated colored cement paste on the surface of a Smooth Face Block will scratch during customary methods of handling and delivery. One block rubbing against another removes the cement paste at the point of impact. This scratch appears as a white chalky line which cannot be removed by washing. Split Face are not as vulnerable to scratching as the aggregates of the exposed concrete matrix mask impact marks. Sandblasted Block are not affected as the entire surface has been etched by sand during the Sandblast process.

Suggested Design Considerations For Using Architectural Smooth Face Block

The wide color range and handling blemishes inherent in Smooth Face Architectural Concrete Block Walls can be minimized by limiting this style of block to small areas of the wall at higher elevations. An example is single course bands of Architectural Smooth Face Block within a field of Split Face.

Often Architectural Smooth Face Block are used for budget reasons after Split Face, Sandblasted or Ground Face Block have been eliminated due to their higher cost. One option is to use regular concrete block and stain the wall afterward. Deep penetrating masonry stains maintain the natural texture of the block and have excellent durability. These colored stains mask jobsite blemishes and blend in the wide range of color visible in regular concrete block walls.

If you have questions on the masonry process, or are interested in learning more on deep penetrating masonry stains, please contact our office at 614.252.0955.

We think you'll agree-in concrete masonry, you won't find a more solid performer than Oberfields.

Oberfields is a value-centered business rich in tradition, innovation, and excellence, with a strong commitment to its people, customers, and the communities in which it does business.

Oberfields is Ohio's leading manufacturer, marketer, and technical resource for superior quality machine made and precast concrete products. OBERFIELDS also distributes a wide selection of top quality resale building materials merchandise to complement its innovative core product offering.

Oberfields has over 50 years of experience serving the concrete products industry. Its three manufacturing plants, four direct sales and distribution yards, and network of dealers and distributors throughout six

states provide residential and commercial markets with a full range of concrete products and related materials including: standard concrete masonry; DesignBLOK® split-face architectural masonry; SpecBrik®; interlocking concrete pavers ; retaining wall systems; sitedscape products; and a full line of concrete masonry building materials. You won't find a more complete line or more industry expertise in the entire region when it comes to standard or architectural concrete masonry. We have Certified Construction Document Technologists on staff to provide full support for our products, including solutions to complex design and construction challenges.

Oberfields serves many primary and secondary customers. Retail customers, do-it-yourselfers, contractors, distributors, government organizations, institutions, retail outlets, builders, architects, engineers, and developers all call on Oberfields for

service. Through five decades of service, Oberfields has become Ohio's supplier of choice by exceeding the demands of design flexibility, aesthetics, structural integrity, durability, fire resistance, sound reduction and thermal qualities.

Our tagline, Solid Performance in Concrete Products®, represents Oberfields belief that high quality concrete products and superior customer service and support leads to a satisfied customer. Oberfields prides itself on its ability to offer customized products and individually tailored solutions to meet your construction needs. Oberfields technically sound sales, marketing, and customer service teams are prepared to answer questions relating to specifications, product applications, and designs or to take an order.

Visit us on the web at oberfields.com

