



TECH-GUIDE

PAVERS
RETAINING WALLS
KITS



OBERFIELDS CONCRETE PAVER AND RETAINING WALLS WARRANTY

OBERFIELDS LLC provides a limited lifetime warranty of its paver, slab, and dry cast wall products and Rosetta® family of precast products for residential applications against manufacturing defects. This Warranty is provided to the original purchaser only, with the original proof of purchase, and is non-transferable.

This Warranty is valid if the material is installed and maintained under industry standards or OBERFIELDS LLC guidelines. Color variances and the appearance of efflorescence do not substantiate a warranty claim. Any product deemed to be defective will be replaced at no charge; however, shipping costs or costs relating to the removal of defective material and replacement labor are not included in this warranty. Color matching cannot be guaranteed.

CONTENTS

PAVERS

Monroe®	4
Washington® & Washington Circle®	5
Vintage Washington® & Vintage Washington Circle®	6
Vintage Belhaven & Vintage Belhaven Circle®	7
Flint Ridge®	8
Vintage Flint Ridge®	9
Tranquility	10
Grand Milestone	11
Grand Lifestyle	12
Destination	13
Unity	14
Bullnose	15
Rosetta® Grand Flagstone	16
Rosetta® Dimensional Flagstone	17
Banas Stones® (natural sandstone)	18
Travertine (natural travertine)	19
Travertine Accessories	20
Ironwood Porcelain	21
Quarcity Porcelain	22
Silex Porcelain	23
ADA Pavers	24
Walk Blocks	25

ECO PAVERS

Turfstone®	26
Renewable	27
H ₂ O Pro	28

RETAINING WALLS

Rosetta® Belvedere*	29
Rosetta® Dimensional Wall *	30
Rosetta® Kodah	31
Rosetta® Dimensional Coping	32
Rosetta® Outcropping	33
Olentangy Bluff Tread™	34
Rosetta® Steps	35
Edington Wall Stone®	36
Non-Weathered Versa-Lok®	37
Non-Weathered Versa-Lok® Mosaic®	38
Weathered Versa-Lok® Mosaic®	39
Versa-Lok® Square Foot	40
Omega	41
Garden Stack™	42

KITS

Edington® Fire Pit Kit	43
Belvedere® Fire Pit Kit	44
Edington® Fireplace Kit	45
Edington® Pub Table Kit	46
Edington® Grill Kit	47
Edington® Water Feature Kit	48
FireRock Fireplaces®	49
Stratford Stone®	50

PAVER PATTERNS

Paver Patterns	51
Paver Circle Patterns	52
Non-Stock Colors	53-55

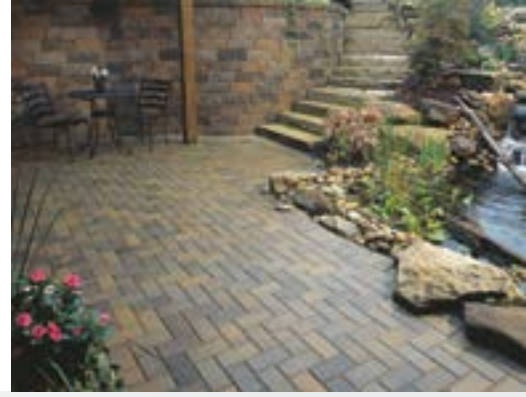

MONROE®

PAVERS

DesignPAVE®

PRODUCT SPECS

a) Monroe® – 4" x 8"

All stocked Monroe® pavers are 2³/₈" thick
 Monroe Pavers also available 3¹/₈" thick, special order only

APPLICATIONS

Pedestrian or light vehicular traffic, residential driveways, patios, borders and swimming pool decks.



INSTALLATION PATTERNS

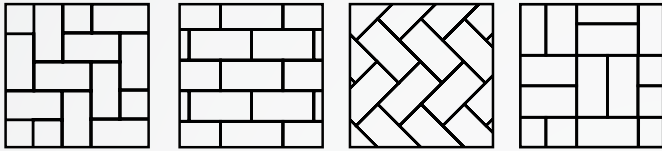

90° Herringbone Running Bond 45° Herringbone Basketweave

PACKAGING INFO

PRODUCT	WEIGHT PER SQ. FT.	UNITS PER SQ. FT.	UNITS PER BAND	UNITS PER CUBE	WEIGHT PER CUBE	SQ. FT. PER UNIT	SQ. FT. PER BAND	SQ. FT. PER CUBE	COLORS STOCKED
Monroe®	27.6	4.7	81	486	2843	0.21	17.17	103	Brown, Canyon Creek, Charcoal, Earth, Flagstone
Monroe® 8cm	36.8	4.7	63	378	2944	0.21	13.23	80	Non-Stock

Note: Due to variations in printing, color selections should always be chosen from actual product samples. Textured paver and patio stone surfaces require a buffer between the plate compactor and the paver surface to prevent scuffing.

COLORS

Canyon Creek Blend

Earth Blend

Flagstone Blend

BANDING AND ACCENTS

Brown

Charcoal

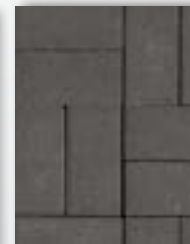
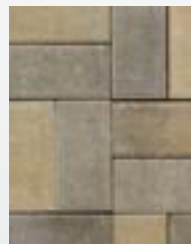
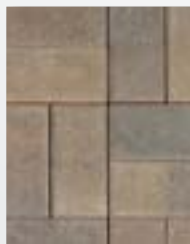
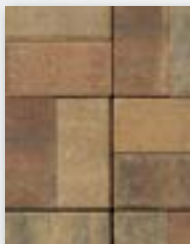



WASHINGTON® & WASHINGTON® CIRCLE

PRODUCT SPECS

- a) Washington® 10 – 4 1/8" x 5 1/2"
- b) Washington® 14 – 5 1/2" x 5 1/2"
- c) Washington® 21 – 5 1/2" x 8 1/4"
- d) Washington® Circle System –
Circle center, small circle paver, large circle paver
- e) Washington® 10 – 4 1/8" x 5 1/2"

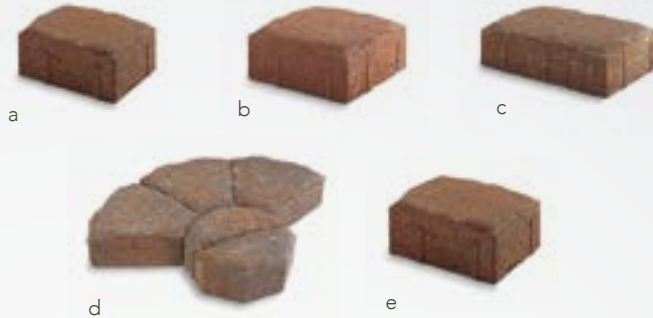

All Washington® Circle Pavers are 2 3/8" thick
 All stocked Washington® Pavers are 2 3/8" thick
 Washington® 14 & 21 Pavers also available 3 1/8" thick

APPLICATIONS

Pedestrian or light vehicular traffic, residential driveways, patios, borders and swimming pool decks.

INSTALLATION PATTERNS

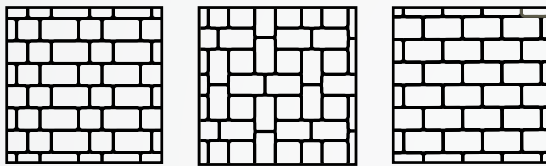

Muster D
40% Wash. 14
60% Wash. 21

Muster K
28% Wash. 14
72% Wash. 21

Running Bond
10, 14, or 21

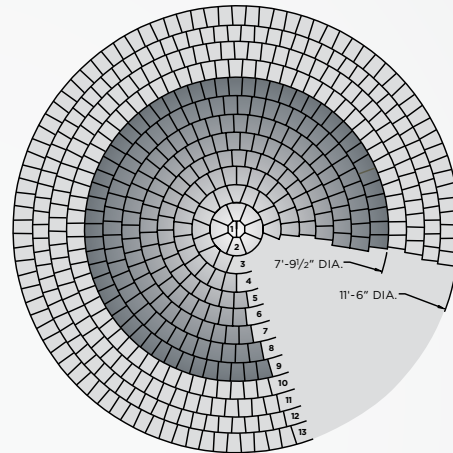

See page 52 for Washington Circle Diagram

PACKAGING INFO

PRODUCT	WEIGHT PER SQ. FT.	UNITS PER SQ. FT.	UNITS PER BAND	UNITS PER CUBE	WEIGHT PER CUBE	SQ. FT. PER UNIT	SQ. FT. PER BAND	SQ. FT. PER CUBE	COLORS STOCKED
Washington® 10	27.6	6.34	80	640	2788	0.16	12.61	101	Canyon Creek, Charcoal, Desert Sand, Earth, Flagstone, Granite
Washington® 14	27.6	4.76	60	480	2760	0.21	12.50	100	Canyon Creek, Charcoal, Earth, Flagstone, Granite
Washington® 21	27.6	3.17	54	324	2815	0.32	17.00	102	Canyon Creek, Charcoal, Desert Sand, Earth, Flagstone, Granite
Washington® Circle	27.6	N/A	N/A	318	1380	Varies	N/A	50	Canyon Creek, Earth, Flagstone, Granite
Washington® 21 8cm	36.8	3.17	42	252	2944	0.32	13.44	80	Non-Stock

Note: Due to variations in printing, color selections should always be chosen from actual product samples. Textured paver and patio stone surfaces require a buffer between the plate compactor and the paver surface to prevent scuffing.

COLORS

Canyon Creek Blend Earth Blend Flagstone Blend Granite Blend

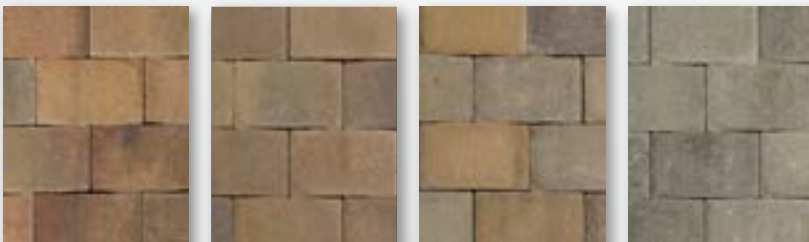

BANDING AND ACCENTS

Charcoal (10s, 14s, 21s) Desert Sand (10s and 21s only)

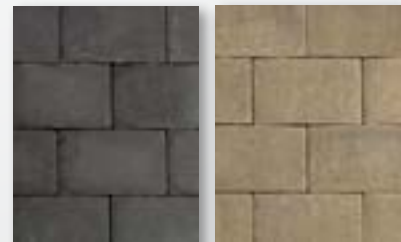

PAVERS
DesignPAVE®



VINTAGE WASHINGTON® & VINTAGE WASHINGTON® CIRCLE

PAVERS

DesignPAVE®

PRODUCT SPECS

- a) **Vintage Washington® 10** – 4¹/₈" x 5¹/₂"
 - b) **Vintage Washington® 14** – 5¹/₂" x 5¹/₂"
 - c) **Vintage Washington® 21** – 5¹/₂" x 8¹/₄"
- All stocked Vintage Washington® Pavers are 2³/₈" thick
 Vintage Washington® 14 & 21 Pavers also available 3¹/₈" thick
- d) **Vintage Washington® Circle** – Circle center, small circle paver, large circle paver, Washington 10's

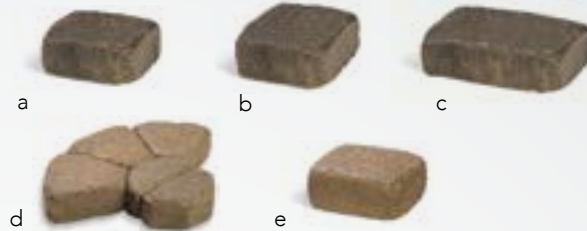

APPLICATIONS

Pedestrian or light vehicular traffic, residential driveways, patios, borders and swimming pool decks.

INSTALLATION PATTERNS

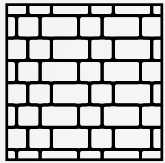

Muster D
 40% Wash. 14
 60% Wash. 21

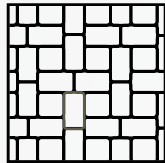

Muster K
 28% Wash. 14
 72% Wash. 21

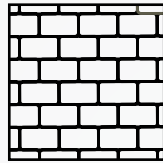

Running Bond
 10, 14, or 21

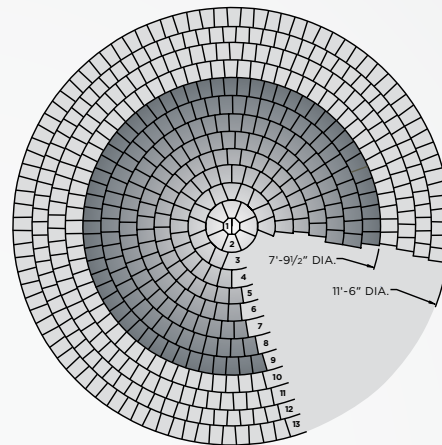

See page 52 for Vintage Washington Circle Diagram

PACKAGING INFO

PRODUCT	WEIGHT PER SQ. FT.	UNITS PER SQ. FT.	UNITS PER BAND	UNITS PER CUBE	WEIGHT PER CUBE	SQ. FT. PER UNIT	SQ. FT. PER BAND	SQ. FT. PER CUBE	COLORS STOCKED
Vintage Washington® 10	27.6	6.34	80	640	2788	0.16	12.61	101	Canyon Creek, Charcoal, Desert Sand, Earth, Flagstone
Vintage Washington® 14	27.6	4.76	60	480	2760	0.21	12.50	100	Canyon Creek, Earth, Flagstone
Vintage Washington® 21	27.6	3.17	54	324	2815	0.32	17.00	102	Canyon Creek, Charcoal, Desert Sand, Earth, Flagstone
Vintage Washington® Circle	27.6	N/A	N/A	318	1380	Varies	N/A	50	Canyon Creek, Earth, Flagstone
Vintage Washington® 21 8 cm	36.8	3.17	42	252	2944	0.32	13.44	80	Non-Stock

Note: Due to variations in printing, color selections should always be chosen from actual product samples. Textured paver and patio stone surfaces require a buffer between the plate compactor and the paver surface to prevent scuffing.

COLORS

Vintage Canyon Creek Blend



Vintage Earth Blend



Vintage Flagstone Blend



BANDING AND ACCENTS

Vintage Charcoal (10s and 21s only)

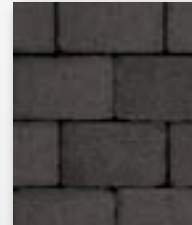

Vintage Desert Sand Blend (10s and 21s only)

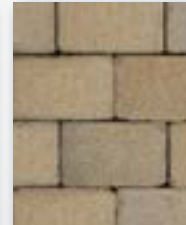



VINTAGE BELHAVEN® & VINTAGE BELHAVEN® CIRCLE

PRODUCT SPECS

- a) **Vintage Belhaven® Small Square** – 5 1/2" x 5 1/2"
 - b) **Vintage Belhaven® Large Square** – 11" x 11"
 - c) **Vintage Belhaven® Small Rectangle** – 5 1/2" x 2 3/4"
 - d) **Vintage Belhaven® Standard Rectangle** – 8 1/4" x 5 1/2"
 - e) **Vintage Belhaven® Large Rectangle** – 11" x 8 1/4"
 - f) **Vintage Belhaven® Jumbo Rectangle** – 16 1/2" x 11"
 - g) **Vintage Belhaven® Circle System** – Circle Center, Small Circle Paver, Large Circle Paver and Rectangle Circle Paver. **SPECIAL ORDER.**
- All Belhaven® pavers are 2 3/4" thick.

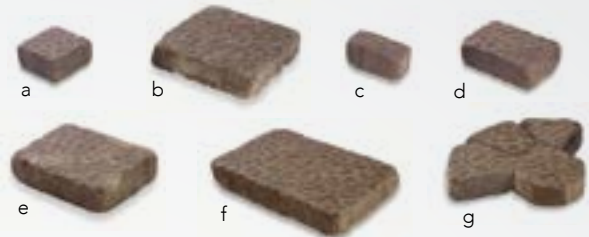

APPLICATIONS

Pedestrian or light vehicular traffic, residential driveways, patios, borders and swimming pool decks.

INSTALLATION PATTERN

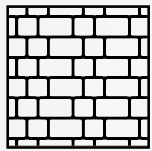

Muster D
40% Small Sq.
60% Standard Rec.

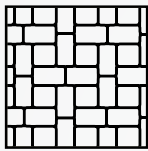

Muster K
28% Small Sq.
72% Standard Rec.

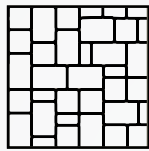

3 Piece Random
51% Standard Rec.
11% Small Rec.
38% Small Sq.

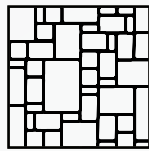

6 Piece Random
29% Jumbo Rec.
17% Large Rec.
18% Standard Rec.
7% Small Rec.
18% Large Sq.
11% Small Sq.

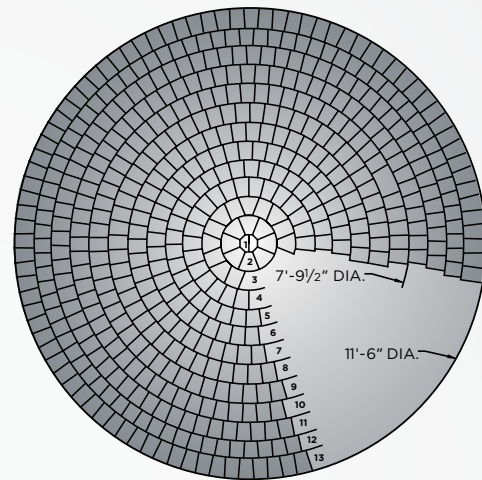

See page 52 for Vintage Belhaven Circle Diagram

PACKAGING INFO

PRODUCT	WEIGHT PER SQ. FT.	UNITS PER SQ. FT.	UNITS PER BAND	UNITS PER CUBE	WEIGHT PER CUBE	SQ. FT. PER UNIT	SQ. FT. PER BAND	SQ. FT. PER CUBE	COLORS STOCKED
Small Square	32.0	4.76	48	384	2592	0.21	10.08	81	Canyon Creek, Earth, Flagstone
Large Square	32.0	1.19	24	96	2592	0.84	20.16	81	Canyon Creek, Earth, Flagstone
Small Rectangle	32.0	9.52	96	768	2592	0.11	10.56	81	Canyon Creek, Earth, Flagstone
Standard Rectangle	32.0	3.17	48	288	2912	0.32	15.36	91	Canyon Creek, Charcoal, Earth, Flagstone
Large Rectangle	32.0	1.58	32	128	2592	0.63	20.16	81	Canyon Creek, Earth, Flagstone
Jumbo Rectangle	32.0	0.79	16	64	2592	1.27	20.32	81	Canyon Creek, Earth, Flagstone
Circle	32.0	N/A	N/A	704	3520	Varies	N/A	110	Non-Stock
Flat Top Charcoal Standard Rectangle	32.0	3.17	48	288	2912	0.32	15.36	91	Charcoal
Vintage Flat Top Standard Rectangle	32.0	3.17	48	288	2912	0.32	15.36	91	Charcoal

Note: Due to variations in printing, color selections should always be chosen from actual product samples. Textured paver and patio stone surfaces require a buffer between the plate compactor and the paver surface to prevent scuffing.

COLORS

Vintage Canyon Creek Blend



Vintage Earth Blend



Vintage Flagstone Blend



BANDING AND ACCENTS

Flat Top Charcoal (Standard Rectangle only)



Vintage Flat Top Charcoal (Standard Rectangle only)



PAVERS
DesignPAVE®



FLINT RIDGE®

PAVERS

DesignPAVE®

PRODUCT SPECS

- a) Flint Ridge® Small Square – 5 1/2" x 5 1/2"
- b) Flint Ridge® Large Square – 11" x 11"
- c) Flint Ridge® Standard Rectangle – 8 1/4" x 5 1/2"
- d) Flint Ridge® Large Rectangle – 11" x 8 1/4"
- e) Flint Ridge® Jumbo Rectangle – 16 1/2" x 11"

All Flint Ridge® pavers are 2 3/4" thick

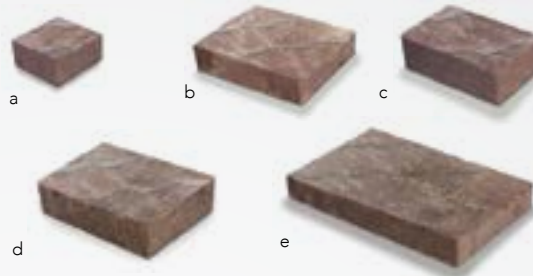

APPLICATIONS

Pedestrian or light vehicular traffic, residential driveways, patios, borders and swimming pool decks.

INSTALLATION PATTERNS

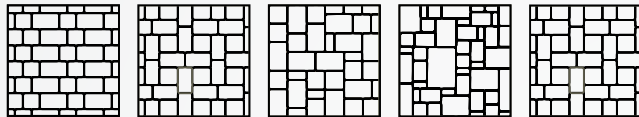

- Muster D
40% Small Sq.
60% Standard Rec.
- Muster K
28% Small Sq.
72% Standard Rec.
- 3 Piece Random
21% Large Rec.
46% Standard Rec.
33% Small Sq.
- 6 Piece Random
30% Jumbo Rec.
18% Large Rec.
20% Standard Rec.
19% Large Sq.
13% Small Sq.
- Jumbo Muster K
28% Large Sq.
72% Jumbo Rec.

PACKAGING INFO

PRODUCT	WEIGHT PER SQ. FT.	UNITS PER SQ. FT.	UNITS PER BAND	UNITS PER CUBE	WEIGHT PER CUBE	SQ. FT. PER UNIT	SQ. FT. PER BAND	SQ. FT. PER CUBE	COLORS STOCKED
Small Square	32.0	4.76	48	384	2592	0.21	10.08	81	Canyon Creek, Earth, Flagstone
Standard Rectangle	32.0	3.17	48	288	2912	0.32	15.36	91	Canyon Creek, Earth, Flagstone
Large Rectangle	32.0	1.58	32	128	2592	0.63	20.16	81	Canyon Creek, Earth, Flagstone
Large Square	32.0	1.19	24	96	2592	0.84	20.16	81	Canyon Creek, Earth, Flagstone
Jumbo Rectangle	32.0	0.79	16	64	2592	1.27	20.32	81	Canyon Creek, Earth, Flagstone
Flat Top Charcoal Standard Rectangle	32.0	3.17	48	288	2912	0.32	15.36	91	Charcoal
Vintage Flat Top Standard Rectangle	32.0	3.17	48	288	2912	0.32	15.36	91	Charcoal

Note: Due to variations in printing, color selections should always be chosen from actual product samples. Textured paver and patio stone surfaces require a buffer between the plate compactor and the paver surface to prevent scuffing.

COLORS

Canyon Creek Blend

Earth Blend

Flagstone Blend



BANDING AND ACCENTS

Flat Top Charcoal (Standard Rectangle only)

Vintage Flat Top Charcoal (Standard Rectangle only)





VINTAGE FLINT RIDGE®

PRODUCT SPECS

- a) Vintage Flint Ridge® Small Square – 5 1/2" x 5 1/2"
- b) Vintage Flint Ridge® Large Square – 11" x 11"
- c) Vintage Flint Ridge® Standard Rectangle – 8 1/4" x 5 1/2"
- d) Vintage Flint Ridge® Large Rectangle – 11" x 8 1/4"
- e) Vintage Flint Ridge® Jumbo Rectangle – 16 1/2" x 11"

All Flint Ridge® pavers are 2 3/4" thick



APPLICATIONS

Pedestrian or light vehicular traffic, residential driveways, patios, borders and swimming pool decks.

INSTALLATION PATTERNS

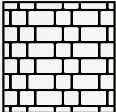
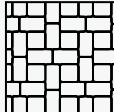
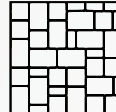
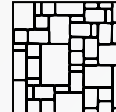
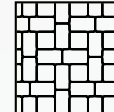
				
Muster D 40% Small Sq. 60% Standard Rec.	Muster K 28% Small Sq. 72% Standard Rec.	3 Piece Random 21% Large Rec. 46% Standard Rec. 33% Small Sq.	6 Piece Random 30% Jumbo Rec. 18% Large Rec. 20% Standard Rec. 19% Large Sq. 13% Small Sq.	Jumbo Muster K 28% Large Sq. 72% Jumbo Rec.

PACKAGING INFO

PRODUCT	WEIGHT PER SQ. FT.	UNITS PER SQ. FT.	UNITS PER BAND	UNITS PER CUBE	WEIGHT PER CUBE	SQ. FT. PER UNIT	SQ. FT. PER BAND	SQ. FT. PER CUBE	COLORS STOCKED
Small Square	32.0	4.76	48	384	2592	0.21	10.08	81	Canyon Creek, Earth, Flagstone
Standard Rectangle	32.0	3.17	48	288	2912	0.32	15.36	91	Canyon Creek, Earth, Flagstone
Large Rectangle	32.0	1.58	32	128	2592	0.63	20.16	81	Canyon Creek, Earth, Flagstone
Large Square	32.0	1.19	24	96	2592	0.84	20.16	81	Canyon Creek, Earth, Flagstone
Jumbo Rectangle	32.0	0.79	16	64	2592	1.27	20.32	81	Canyon Creek, Earth, Flagstone
Flat Top Charcoal Standard Rectangle	32.0	3.17	48	288	2912	0.32	15.36	91	Charcoal
Vintage Flat Top Standard Rectangle	32.0	3.17	48	288	2912	0.32	15.36	91	Charcoal

Note: Due to variations in printing, color selections should always be chosen from actual product samples. Textured paver and patio stone surfaces require a buffer between the plate compactor and the paver surface to prevent scuffing.

COLORS

Vintage Canyon Creek Blend



Vintage Earth Blend



Vintage Flagstone Blend

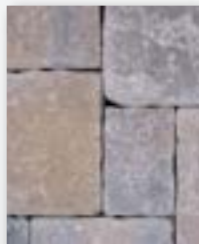

BANDING AND ACCENTS

Flat Top Charcoal (Standard Rectangle only)



Vintage Flat Top Charcoal (Standard Rectangle only)





TRANQUILITY

Face-Mix
ColorFast

FACE-MIX PAVERS

PRODUCT SPECS

- a) Tranquility A – 9¹/₄" x 4⁵/₈"
- b) Tranquility B – 9¹/₄" x 9¹/₄"
- c) Tranquility C – 14" x 9³/₄"
- d) Tranquility D – 14" x 14"
- e) Tranquility E – 18¹/₄" x 9³/₄"

All Tranquility pavers are 2³/₄" thick
 All Tranquility pavers are sold by layer or cube, not by piece.

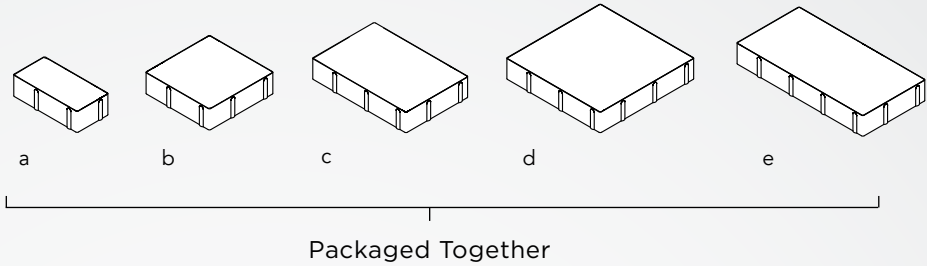

APPLICATIONS

Pedestrian or light vehicular traffic, residential driveways, patios, borders and swimming pool decks.

PATTERNS:

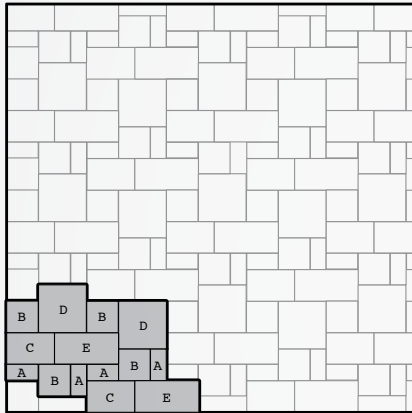

Pattern 1

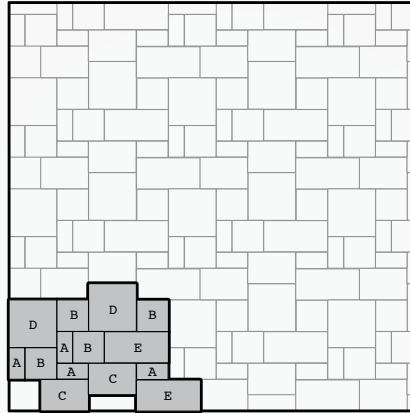

Pattern 2

LAYER CONFIGURATION:

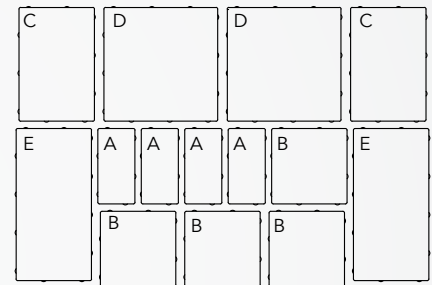

PACKAGING INFO

PRODUCT	SF PER LAYER	LAYERS PER CUBE	WT PER CUBE	SF PER CUBE	COLORS STOCKED
Tranquility-A	10.77	8.00	2910	86.16	Calm, Haven, Oasis, Serenity, Timeless
Tranquility-B	10.77	8.00	2910	86.16	Calm, Haven, Oasis, Serenity, Timeless
Tranquility-C	10.77	8.00	2910	86.16	Calm, Haven, Oasis, Serenity, Timeless
Tranquility-D	10.77	8.00	2910	86.16	Calm, Haven, Oasis, Serenity, Timeless
Tranquility-E	10.77	8.00	2910	86.16	Calm, Haven, Oasis, Serenity, Timeless

Note: Due to variations in printing, color selections should always be chosen from actual product samples. Textured paver and patio stone surfaces require a buffer between the plate compactor and the paver surface to prevent scuffing.

COLORS

Calm



Haven

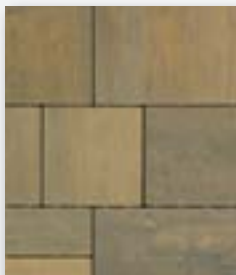

Oasis

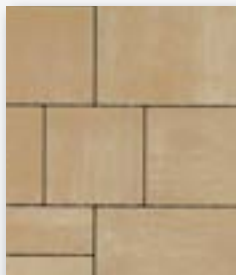

Serenity



Timeless





GRAND MILESTONE



PRODUCT SPECS

k) **Grand Milestone K** – 11⁵/₈" x 11⁵/₈"

l) **Grand Milestone L** – 11⁵/₈" x 17¹/₂"

m) **Grand Milestone M** – 11⁵/₈" x 23¹/₂"

All Grand Milestone pavers are 2³/₄" thick

All Grand Milestone pavers are sold by layer or cube, not by piece.

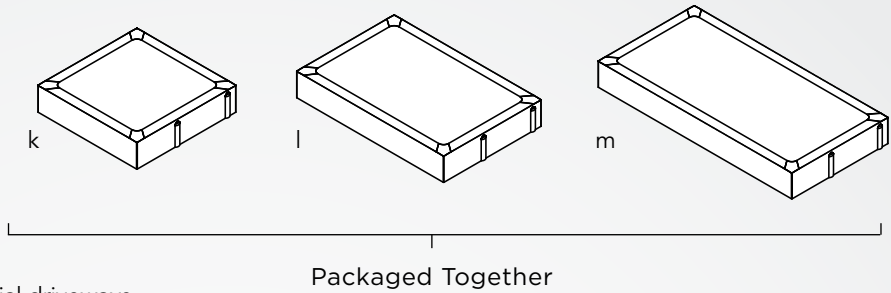

APPLICATIONS

Pedestrian or light vehicular traffic, residential driveways, patios, borders and swimming pool decks.

LAYER CONFIGURATION:

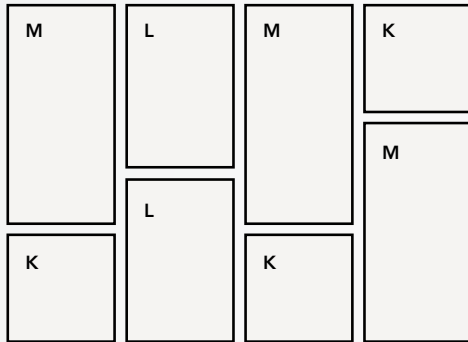

Running Bond Pattern

PACKAGING INFO

PRODUCT	SF PER LAYER	LAYERS PER CUBE	WT PER CUBE	SF PER CUBE	COLORS STOCKED
Grand Milestone-K	11.36	8	3070	90.88	Calm, Haven, Oasis, Serenity, Timeless
Grand Milestone-L	11.36	8	3070	90.88	Calm, Haven, Oasis, Serenity, Timeless
Grand Milestone-M	11.36	8	3070	90.88	Calm, Haven, Oasis, Serenity, Timeless

Note: Due to variations in printing, color selections should always be chosen from actual product samples. Textured paver and patio stone surfaces require a buffer between the plate compactor and the paver surface to prevent scuffing.

COLORS

Calm

Haven

Oasis

Serenity

Timeless

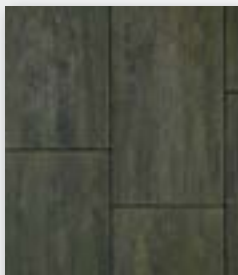

GRAND LIFESTYLE



FACE-MIX PAVERS

PRODUCT SPECS

- f) **Grand Lifestyle F** – 5¹⁵/₁₆" x 11¹⁵/₁₆"
- g) **Grand Lifestyle G** – 5¹⁵/₁₆" x 17¹⁵/₁₆"
- h) **Grand Lifestyle H** – 11¹⁵/₁₆" x 11¹⁵/₁₆"
- i) **Grand Lifestyle I** – 11¹⁵/₁₆" x 17¹⁵/₁₆"
- j) **Grand Lifestyle J** – 17¹⁵/₁₆" x 17¹⁵/₁₆"

All Grand Lifestyle pavers are 2³/₄" thick
 All Grand Lifestyle pavers are sold by layer or cube, not by piece.

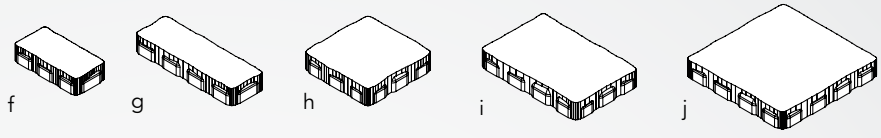

Packaged Together

APPLICATIONS

Pedestrian or light vehicular traffic, residential driveways, patios, borders and swimming pool decks.

PATTERNS

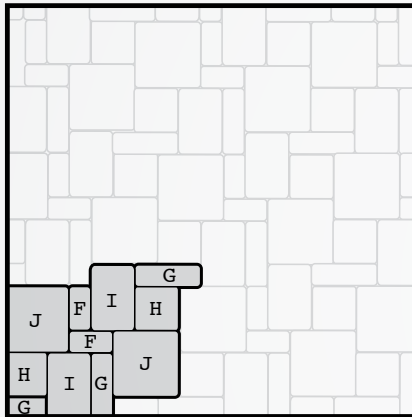

Pattern 1

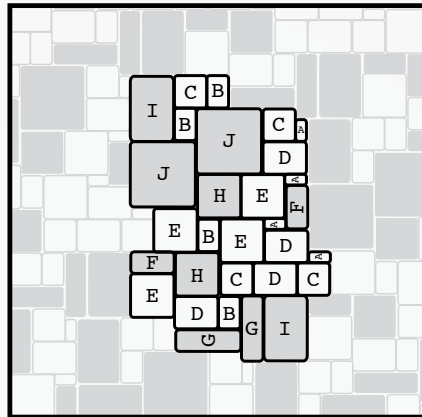

Pattern 2
 Combination Lifestyle & Grand Lifestyle

LAYER CONFIGURATION:

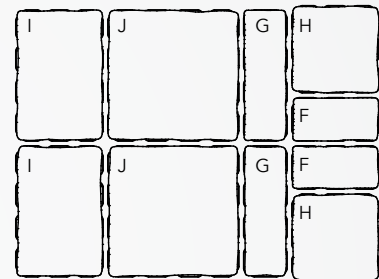

PACKAGING INFO

PRODUCT	SF PER LAYER	LAYERS PER CUBE	WT PER CUBE	SF PER CUBE	COLORS STOCKED
Lifestyle-F	12.33	8	3330	98.64	Haven, Oasis, Serenity, Timeless
Lifestyle-G	12.33	8	3330	98.64	Haven, Oasis, Serenity, Timeless
Lifestyle-H	12.33	8	3330	98.64	Haven, Oasis, Serenity, Timeless
Lifestyle-I	12.33	8	3330	98.64	Haven, Oasis, Serenity, Timeless
Lifestyle-J	12.33	8	3330	98.64	Haven, Oasis, Serenity, Timeless

Note: Due to variations in printing, color selections should always be chosen from actual product samples. Textured paver and patio stone surfaces require a buffer between the plate compactor and the paver surface to prevent scuffing.

COLORS

Haven



Oasis



Serenity



Timeless





DESTINATION



PRODUCT SPECS

- a) **Destination A** – 3¹/₈" H (D & L Vary)
- b) **Destination B** – 3¹/₈" H (D & L Vary)
- c) **Destination C** – 3¹/₈" H (D & L Vary)
- d) **Destination D** – 3¹/₈" H (D & L Vary)
- e) **Destination E** – 3¹/₈" H (D & L Vary)
- f) **Destination F** – 3¹/₈" H (D & L Vary)
- g) **Destination G** – 3¹/₈" H (D & L Vary)
- h) **Destination H** – 3¹/₈" H (D & L Vary)
- i) **Destination I** – 3¹/₈" H (D & L Vary)

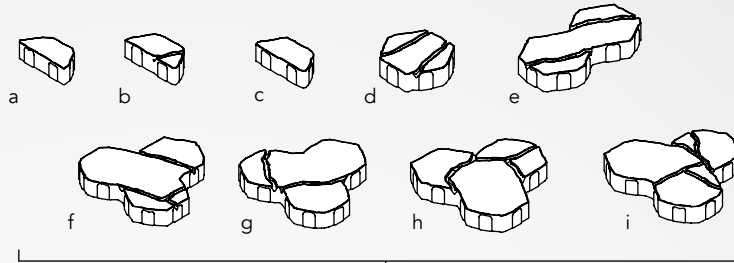

Packaged Together

All Destination pavers are 3¹/₈" thick
 All Destination pavers are sold by layer or cube, not by piece.

PATTERNS

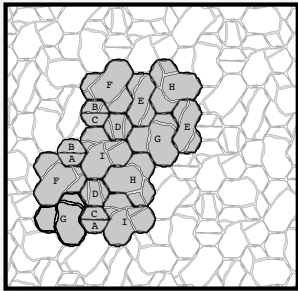

Pattern 1

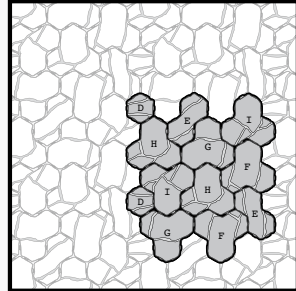

Pattern 2

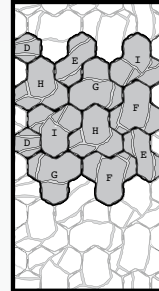

Sidewalk Pattern

LAYER CONFIGURATION:

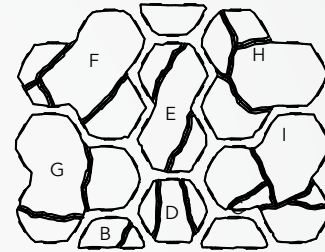

PACKAGING INFO

PRODUCT	SF PER LAYER	LAYERS PER CUBE	WT PER CUBE	SF PER CUBE	COLORS STOCKED
Destination-A	11.11	8	3000	88.88	Haven, Oasis, Serenity, Timeless
Destination-B	11.11	8	3000	88.88	Haven, Oasis, Serenity, Timeless
Destination-C	11.11	8	3000	88.88	Haven, Oasis, Serenity, Timeless
Destination-D	11.11	8	3000	88.88	Haven, Oasis, Serenity, Timeless
Destination-E	11.11	8	3000	88.88	Haven, Oasis, Serenity, Timeless
Destination-F	11.11	8	3000	88.88	Haven, Oasis, Serenity, Timeless
Destination-G	11.11	8	3000	88.88	Haven, Oasis, Serenity, Timeless
Destination-H	11.11	8	3000	88.88	Haven, Oasis, Serenity, Timeless
Destination-I	11.11	8	3000	88.88	Haven, Oasis, Serenity, Timeless

Note: Due to variations in printing, color selections should always be chosen from actual product samples.
 Textured paver and patio stone surfaces require a buffer between the plate compactor and the paver surface to prevent scuffing.

COLORS

Haven



Oasis



Serenity



Timeless



UNITY

Face-Mix
ColorFast



PRODUCT SPECS

a) **Unity Paver** – 4" x 8"

All Unity pavers are 2³/₄" thick

Stocked in **Rough and Smooth** textures

Other textures available as special order are:

Hammered, Tumbled

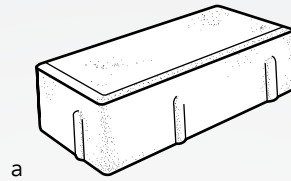

APPLICATIONS

Pedestrian or light vehicular traffic, residential driveways, commercial applications, patios, borders and swimming pool decks.

PATTERNS

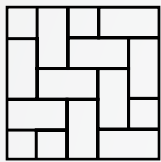

90° Herringbone

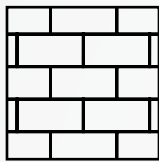

Running Bond

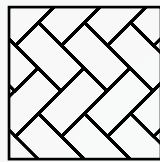

45° Herringbone

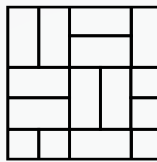

Basketweave

Note: Pavers can be installed on their own as machine-layable pavers.

LAYER CONFIGURATION:

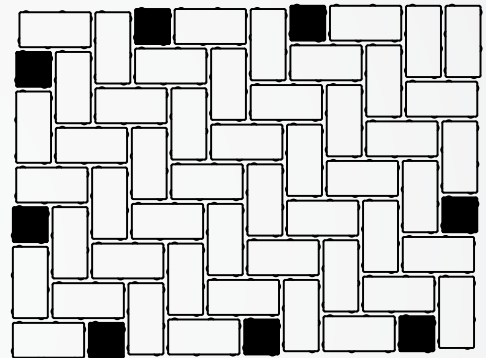

Note: 4 x 4 fillers (see black squares in illustration) are used to keep the integrity of a layer when placed by a machine. They are no charge and not sold separately. If 4 x 4 fillers are used in a pattern and more are needed, installers can cut 4 x 8 pavers in half and install where needed.

PACKAGING INFO

PRODUCT	SF PER LAYER	LAYERS PER CUBE	WT PER CUBE	SF PER CUBE	COLORS STOCKED
Unity	11	8	2996	88	Rough and Smooth Textures: Homecoming, Reflection, Vision

Note: Due to variations in printing, color selections should always be chosen from actual product samples. Textured paver and patio stone surfaces require a buffer between the plate compactor and the paver surface to prevent scuffing.

COLORS

Shown in rough texture

Homecoming Rough

Reflection Rough

Vision Rough

Homecoming Smooth

Reflection Smooth

Vision Smooth

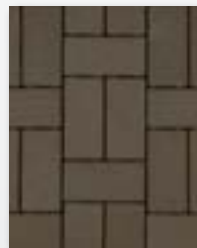



BULLNOSE PAVERS

PRODUCT SPECS

- a) **Single Bullnose** – 6" X 12"
- b) **Vintage Single Bullnose** – 6" X 12"
- c) **Double Bullnose** – 6" X 12"
- d) **Vintage Double Bullnose** – 6" X 12"

All Bullnose pavers are 2³/₄" thick

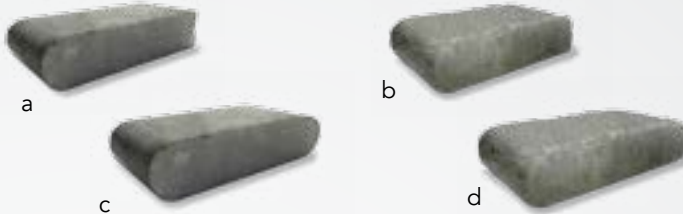

APPLICATIONS

Steps, wall caps and coping applications.

PAVERS
DesignPAVE®

PACKAGING INFO

PRODUCT	WEIGHT PER SQ. FT.	UNITS PER SQ. FT.	UNITS PER BAND	UNITS PER CUBE	WEIGHT PER CUBE	SQ. FT. PER UNIT	SQ. FT. PER BAND	SQ. FT. PER CUBE	COLORS STOCKED
Single Bullnose Paver	30.0	2.00	N/A	192	2880	0.50	N/A	96	Canyon Creek, Charcoal, Dark Chocolate, Desert Sand, Earth, Flagstone
Vintage Single Bullnose Paver	30.0	2.00	N/A	192	2880	0.50	N/A	96	Canyon Creek, Charcoal, Dark Chocolate, Desert Sand, Earth, Flagstone
Double Bullnose Paver	30.0	2.00	N/A	192	2880	0.50	N/A	96	Canyon Creek, Charcoal, Dark Chocolate, Desert Sand, Earth, Flagstone
Vintage Double Bullnose Paver	30.0	2.00	N/A	192	2880	0.50	N/A	96	Canyon Creek, Charcoal, Dark Chocolate, Desert Sand, Earth, Flagstone

Note: Due to variations in printing, color selections should always be chosen from actual product samples. Textured paver and patio stone surfaces require a buffer between the plate compactor and the paver surface to prevent scuffing.

COLORS





ROSETTA® GRAND FLAGSTONE

PAVERS

DesignPAVE®

PRODUCT SPECS

Rosetta® Grand Flagstone*

Dimensions – All Grand Flagstone is 1³/₄" thick

All Grand Flagstone sold by layer or cube, not by piece.

Note: Outside dimensions of each layer are identical to all other layers, allowing any layer to be used anywhere in the pattern.

Each pallet contains 2 each of the following layers:



APPLICATIONS

Pedestrian traffic, patios, borders and swimming pool decks.

INSTALLATION PATTERNS

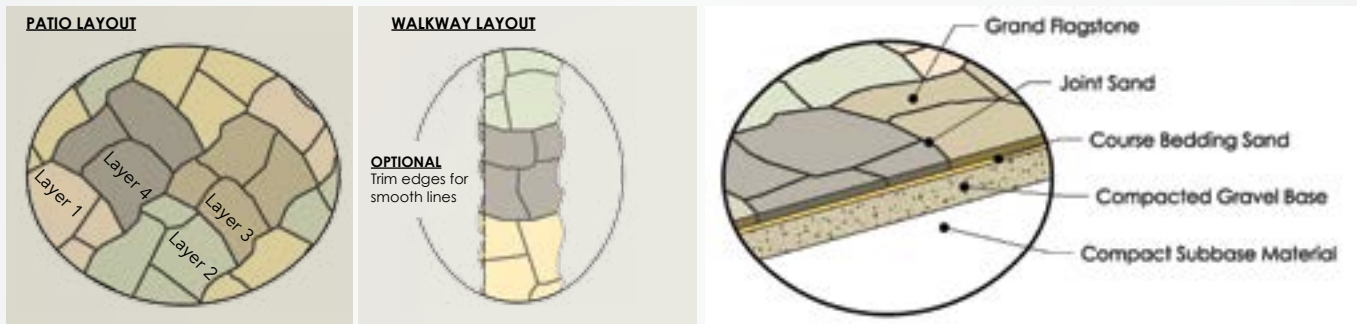

PACKAGING INFO

PRODUCT	WEIGHT PER SQ. FT.	UNITS PER SQ. FT.	LAYERS PER CUBE	UNITS PER CUBE	WEIGHT PER CUBE	SQ. FT. PER UNIT	SQ. FT. PER LAYER	SQ. FT. PER CUBE	COLORS STOCKED
Grand Flagstone	20.5	N/A	8	32	2160	N/A	11	88	Cuyahoga, Scioto

Note: Due to variations in printing, color selections should always be chosen from actual product samples. Textured paver and patio stone surfaces require a buffer between the plate compactor and the paver surface to prevent scuffing.

COLORS

Cuyahoga Blend



Scioto Blend





ROSETTA® DIMENSIONAL FLAGSTONE

PRODUCT SPECS

- a) Rosetta® Dimensional Flagstone* – 6" x 12"
- b) Rosetta® Dimensional Flagstone* – 12" x 12"
- c) Rosetta® Dimensional Flagstone* – 12" x 18"
- d) Rosetta® Dimensional Flagstone* – 18" x 18"
- e) Rosetta® Dimensional Flagstone* – 18" x 24"
- f) Rosetta® Dimensional Flagstone* – 24" x 24"

All Dimensional Flagstone are 2" thick
 All Dimensional Flagstone sold by layer, not by piece.

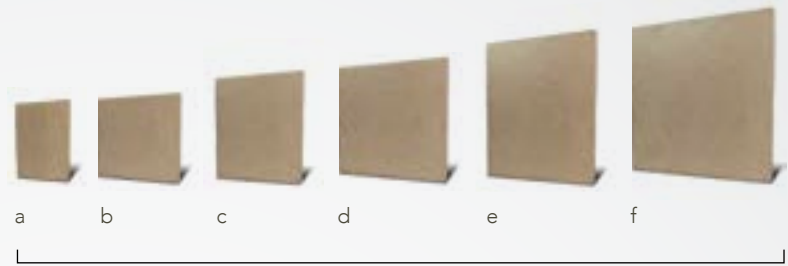

Packaged together

APPLICATIONS

Pedestrian traffic, patios, borders and swimming pool decks.

INSTALLATION PATTERNS

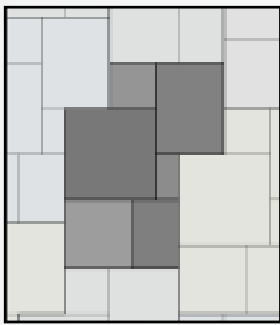

Patio Layout



Walkway Layout

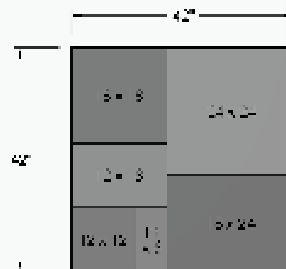
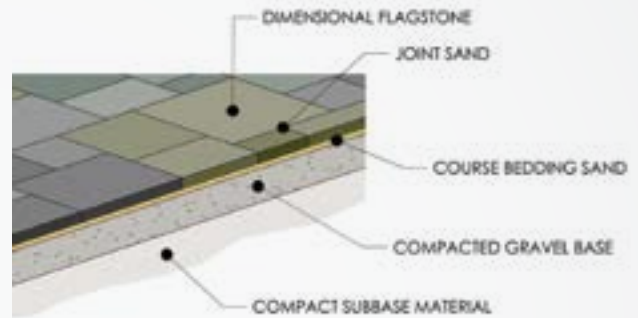

One Layer = 1 Pattern

PACKAGING INFO

PRODUCT	WEIGHT PER SQ. FT.	UNITS PER SQ. FT.	LAYERS PER CUBE	UNITS PER CUBE	WEIGHT PER CUBE	SQ. FT. PER UNIT	SQ. FT. PER BAND	SQ. FT. PER CUBE	COLORS STOCKED
Dimensional Flagstone	24.0	N/A	8	48	2350	N/A	12.25	98	Bluestone, Cuyahoga, Scioto

Note: Due to variations in printing, color selections should always be chosen from actual product samples. Textured paver and patio stone surfaces require a buffer between the plate compactor and the paver surface to prevent scuffing.

COLORS

Bluestone Blend



Cuyahoga Blend



Scioto Blend



PAVERS
DesignPAVE®



BANAS STONES®

PAVERS

SANDSTONE

PRODUCT SPECS

- a) Banas Stone Sandstone – 11.81" x 23.62"
- b) Banas Stone Sandstone – 17.72" x 23.62"
- c) Banas Stone Sandstone – 23.62" x 23.62"
- d) Banas Stone Sandstone – 23.62" x 35.43"
- e) Banas Stone Sandstone – 11.81" x 23.62"



Banas Stone pavers are 1" thick

APPLICATIONS

Pedestrian traffic, patios, borders and swimming pool decks.

INSTALLATION PATTERN

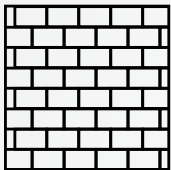

Running Bond
 11.81" x 23.62",
 17.72" x 23.62", or
 23.62" x 35.43"

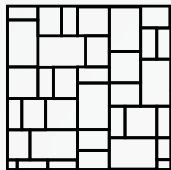

4 Piece Random
 25% 11.81" x 23.62"
 30% 17.72" x 23.62"
 25% 23.62" x 35.43"
 20% 23.62" x 23.62"

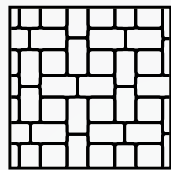

Jumbo Muster K
 28% Large Sq.
 72% Jumbo Rec.

POOL COPING

Standard Length: 24", 48", 60" and 72"
 Standard Width: 12" and 16"
 Standard Thickness: 2"

Finishes: Top Natural, Bottom Calibrated, Edges Bullnosed and Sawn, Edges Rock Faced on Front and Sawn

WALL COPING

Standard Length: 24", 48", 60" and 72"
 Standard Width: 12", 14" and 16"
 Standard Thickness: 2"

Finishes: Top Natural, Bottom Calibrated, Edges Bullnosed and Sawn, Edges Rock Faced on Front and Sawn

STEPS

Standard Length: 48", 60", 72", 84" and 96"
 Standard Width: 16"
 Standard Thickness: 6" and 7"

Finishes: Top Natural, Bottom Calibrated, Edges Bullnosed and Sawn, Edges Rock Faced on Front and Sawn
 Curbs, Step Fillers, Pier Caps and Circles also available.
 Special Order Only

PACKAGING INFO

PRODUCT	WEIGHT PER SQ. FT.	UNITS PER SQ. FT.	UNITS PER BAND	UNITS PER CUBE	WEIGHT PER CUBE	SQ. FT. PER UNIT	SQ. FT. PER BAND	SQ. FT. PER CUBE	COLORS STOCKED
Banas Stones Sandstone® 11.81" x 23.62"	13.2	N/A	N/A	80	2000	N/A	N/A	160	Bronte, Flint, Fossil, Silver Grey, Slate Grey
Banas Stones Sandstone® 17.72" x 23.62"	13.2	N/A	N/A	80	2800	N/A	N/A	240	Bronte, Flint, Fossil, Silver Grey, Slate Grey
Banas Stones Sandstone® 23.62" x 23.62"	13.2	N/A	N/A	40	2000	N/A	N/A	160	Bronte, Flint, Fossil, Silver Grey, Slate Grey
Banas Stones Sandstone® 23.62" x 35.43"	13.2	N/A	N/A	40	2800	N/A	N/A	240	Bronte, Flint, Fossil, Silver Grey, Slate Grey
Banas Stones Limestone® 11.81" x 23.62"	16.5	N/A	N/A	74	2100	N/A	N/A	148	Kota Black

Note: Due to variations in printing, color selections should always be chosen from actual product samples.
 Do not use a plate compactor on Banas Stones. Install Banas over a 411 base.

SANDSTONE COLORS

Bronte



Flint

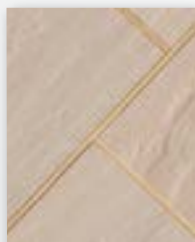

Fossil



Silver Grey

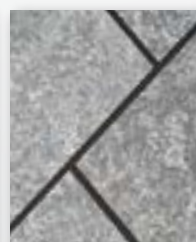

Slate Grey

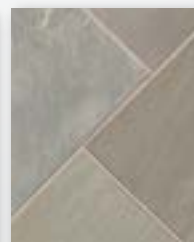

Kota Black



LIMESTONE COLORS

TRAVERTINE



PRODUCT SPECS

- a) Travertine Small Square – 8" x 8"
- b) Travertine Small Rectangle – 8" x 16"
- c) Travertine Large Square – 16" x 16"
- d) Travertine Large Rectangle – 16" x 24"
- e) Travertine Bullnose – 12" x 24"

Travertine pavers are 1 1/4" thick
 Bullnose units are special order

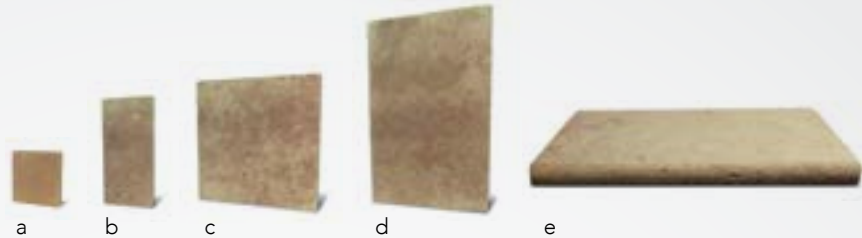

APPLICATIONS

Pedestrian traffic, patios, borders and swimming pool decks.

INSTALLATION PATTERNS

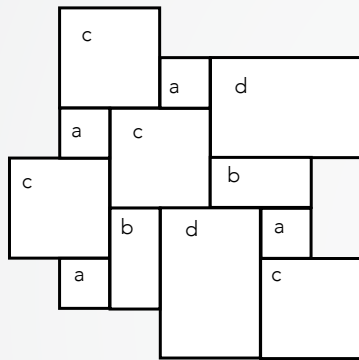

French Pattern

PACKAGING INFO

PRODUCT	WEIGHT PER SQ. FT.	UNITS PER SQ. FT.	UNITS PER BAND	UNITS PER CUBE	WEIGHT PER CUBE	SQ. FT. PER UNIT	SQ. FT. PER BAND	SQ. FT. PER CUBE	COLORS STOCKED
Travertine	15.0	N/A	N/A	N/A	2640	N/A	N/A	176	Classic Ivory, Noche, Tuscany, Walnut

Note: Due to variations in printing, color selections should always be chosen from actual product samples. Do not use a plate compactor on Travertine.

COLORS

Classic Ivory



Noche

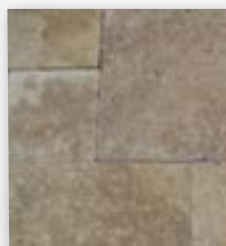

Tuscany



Walnut





TRAVERTINE ACCESSORIES

PAVERS

TRAVERTINE

PRODUCT SPECS

- a) Travertine Mini Slabs – 38" x 48" x 2"
- b) Travertine Coping – 16" x 72" x 2"
- c) Travertine Bullnose Column Cap – 24" x 24" x 2"
- d) Travertine Remodeling Coping – 4" x 9" x 1.25"



a



b



c



d

PACKAGING INFO

PRODUCT	UNITS PER CUBE	WEIGHT PER CUBE	NON-STOCK COLORS AVAILABLE
Travertine Mini Slabs 36" x 48" x 2"	10	3100	Classic Ivory, Noche, Tuscany, Walnut
Travertine Coping 12" x 24" x 1.25"	66	2100	Classic Ivory, Greige, Noche, Silver, Tuscany, Walnut
Travertine Coping 16" x 24" x 1.25"	66	2100	Classic Ivory, Greige, Noche, Silver, Tuscany, Walnut
Travertine Coping 12" x 24" x 2"	40	2100	Classic Ivory, Greige, Noche, Silver, Tuscany, Walnut
Travertine Coping 12" x 48" x 2"	40	4100	Classic Ivory, Greige, Noche, Silver, Tuscany, Walnut
Travertine Coping 12" x 72" x 2"	20	3100	Classic Ivory, Greige, Noche, Silver, Tuscany, Walnut
Travertine Coping 16" x 24" x 2"	40	2800	Classic Ivory, Greige, Noche, Silver, Tuscany, Walnut
Travertine Coping 16" x 48" x 2"	20	2800	Classic Ivory, Greige, Noche, Silver, Tuscany, Walnut
Travertine Coping 16" x 72" x 2"	20	4100	Classic Ivory, Greige, Noche, Silver, Tuscany, Walnut
Travertine Bullnose Column Cap 24" x 24" x 2"	20	2100	Classic Ivory, Noche, Silver, Tuscany, Walnut
Travertine Remodeling Coping 4" x 9" x 1.25"	112	2400	Classic Ivory, Greige, Noche, Silver, Tuscany, Walnut
Travertine Remodeling Coping 12" x 12" x 1.25"	80	1500	Classic Ivory, Greige, Noche, Silver, Tuscany, Walnut
Travertine Split Face Veneer Wall Stone 4" Tall with Random Lengths	84 bundles of 2.7sq. ft.	3200	Classic Ivory, Noche, Silver, Tuscany, Walnut
Travertine Split Face Veneer Corners			Classic Ivory, Noche, Silver, Tuscany, Walnut
Fire Place Kit			
Waterfall Kit			

Note: Due to variations in printing, color selections should always be chosen from actual product samples. Do not use a plate compactor on Banas Stones. Install Banas over a 411 base.

NON-STOCK COLORS AVAILABLE

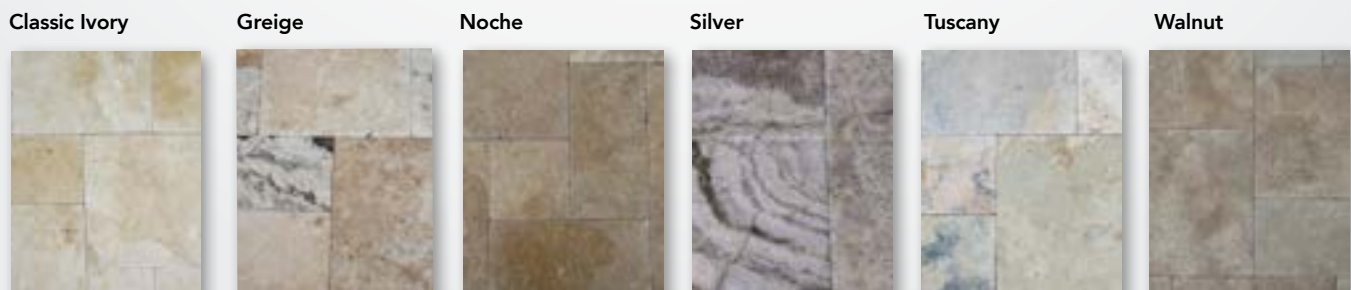



IRONWOOD PORCELAIN

PRODUCT SPECS

- a) Ironwood Rectangle – 9" x 36"
- b) Ironwood Large Square – 24" x 24"

Ironwood pavers are 20mm thick
 A 4 mm or 5 mm joint is required on all porcelain applications.

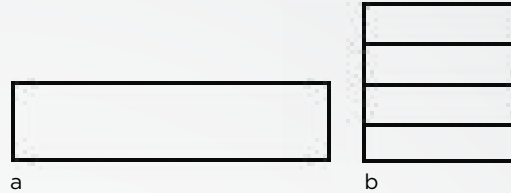

APPLICATIONS

Pedestrian traffic, patios, borders, swimming pool decks, overlays and rooftop applications.

PAVERS

PORCELAIN

PACKAGING INFO

PRODUCT	UNITS PER BOX	UNITS PER CUBE	BOXES PER CUBE	SQ. FT. PER UNIT	SQ. FT. PER BOX	TOTAL SQ. FT. PER CUBE	WEIGHT PER BOX	WEIGHT PER CUBE	COLORS STOCKED
Ironwood 9" x 36"	2	84	42	2.25	4.5	189	41.4	1800	Abeto, Ebano, Fresno, Olivo
Ironwood 24" x 24"	2	60	30	4	8	240	75	2309	Abeto, Ebano, Fresno, Olivo

Note: Due to variations in printing, color selections should always be chosen from actual product samples.
 Do not use a plate compactor on porcelain pavers.
 Install over a 411 and 89 base.

COLORS

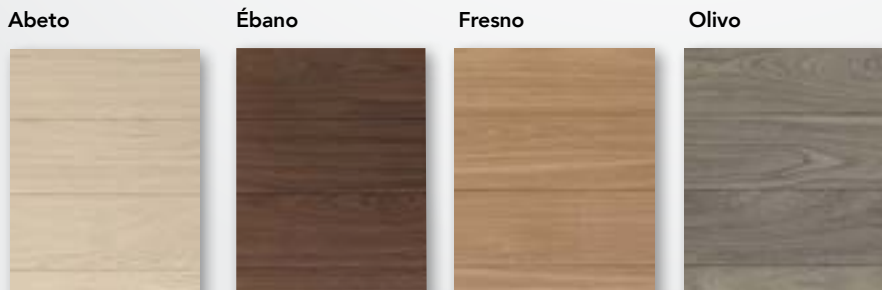

QUARCITY PORCELAIN



PAVERS

PRODUCT SPECS

a) **Quarcity Large Square** – 24" x 24"

Quarcity pavers are 20mm thick

A 4 mm or 5 mm joint is required on all porcelain applications.



a

APPLICATIONS

Pedestrian traffic, patios, borders, swimming pool decks, overlays and rooftop applications.

DesignPAVE®

PACKAGING INFO

PRODUCT	UNITS PER BOX	UNITS PER CUBE	BOXES PER CUBE	SQ. FT. PER UNIT	SQ. FT. PER BOX	TOTAL SQ. FT. PER CUBE	WEIGHT PER BOX	WEIGHT PER CUBE	COLORS STOCKED
Quarcity 24"x24"	2	60	30	4	8	240	75	2309	Beige, Grafito, Gris, Midnight

Note: Due to variations in printing, color selections should always be chosen from actual product samples. Do not use a plate compactor on porcelain pavers. Install over a 411 and 89 base.

COLORS

Beige



Grafito



Gris



Midnight



SILEX PORCELAIN



PRODUCT SPECS

a) **Silex Large Square** – 24" x 24"

Silex pavers are 20mm thick

A 4 mm or 5 mm joint is required on all porcelain applications.



a

APPLICATIONS

Pedestrian traffic, patios, borders, swimming pool decks, overlays and rooftop applications.

PACKAGING INFO

PRODUCT	UNITS PER BOX	UNITS PER CUBE	BOXES PER CUBE	SQ. FT. PER UNIT	SQ. FT. PER BOX	TOTAL SQ. FT. PER CUBE	WEIGHT PER BOX	WEIGHT PER CUBE	COLORS STOCKED
Silex 24"x24"	2	60	30	4	8	240	75	2309	Gris, Tabaco

Note: Due to variations in printing, color selections should always be chosen from actual product samples. Do not use a plate compactor on porcelain pavers. Install over a 411 and 89 base.

COLORS

Gris

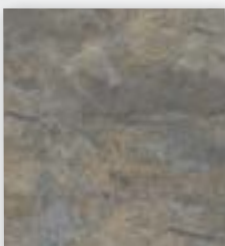

Tabaco

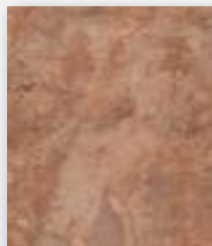

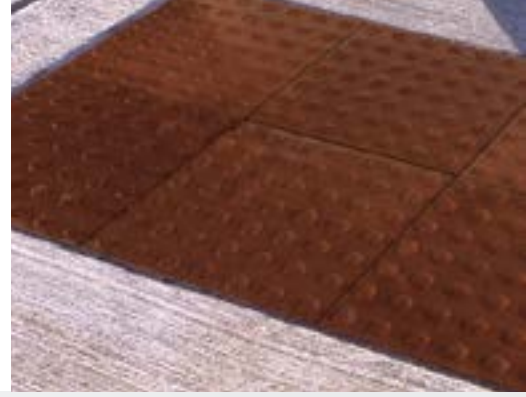

ADA PAVERS

PRODUCT SPECS

a) ADA Pavers – 11⁷/₁₆" x 11⁷/₁₆" x 2³/₈"

Non-stocking, special order product.

APPLICATIONS

Sidewalk or curb applications where a detectable warning surface is desired.

Our ADA Detectable Warning Pavers are manufactured in accordance to Section 705 Detectable Warnings of the Department of Justice's 2010 "ADA Standards for Accessible Design."

According to ADA guidelines:

A detectable warning is a standardized surface feature, built in or applied to, walking surfaces or other elements to warn of hazards on a circulation path.

The color of the detectable warning surface shall contrast visually with adjacent walking surfaces, either light on dark, or dark on light.

ADA Paver Characteristics

- Meets ADA requirements for slip resistance
- Meets ASTM C936 and ACI 530 specifications
- Truncated dome pattern is produced in parallel alignment
- Paver surface can be sandblasted for an alternative surface texture
- Size decreases installation time
- Little or no maintenance required
- Cleaning and sealing information available upon request



a

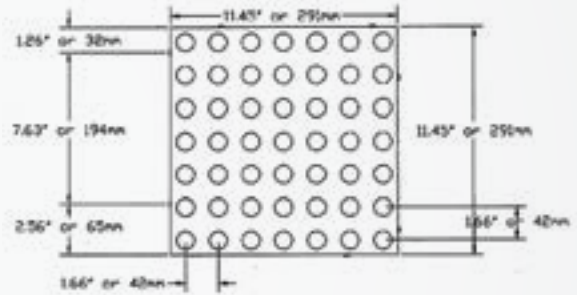
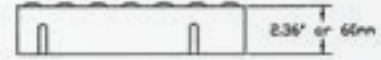
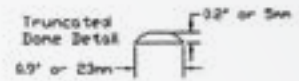

Note: Due to variations in printing, color selections should always be chosen from actual product samples. Textured paver and patio stone surfaces require a buffer between the plate compactor and the paver surface to prevent scuffing.

SPECIAL ORDER COLORS

Charcoal



Red



WALK BLOCKS



PRODUCT SPECS

- a) **Brick Face** – 18" x 18"
- b) **Brick Face** – 24" x 24"
- c) **Round Patio Stone** – 12" x 12"
- d) **Round Patio Stone** – 18" x 18"
- e) **Square Patio Stone** – 18" x 18"



All walk blocks are 2" thick, and sides have a slight taper.

APPLICATIONS

For exterior walks and landscape accents.

Dense Concrete Walk Blocks



12" x 12"
99 per Pallet

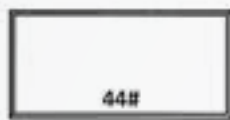

12" x 24"
48 per Pallet



18" x 18"
48 per Pallet



24" x 24"
24 per Pallet



30" x 30"
12 per Pallet



36" x 36"
12 per Pallet



12" Round
99 per Pallet



18" Round
48 per Pallet



24" Round
24 per Pallet

Available Finishes:

- Exposed Aggregate #1: Gray, crushed limestone, 3/8" top size.
- Exposed Aggregate #2: Pea Gravel, 1/2" top size.
- Smooth As-Cast Surfaces: Natural, concrete color

Machine-Made Walk Blocks



18" x 18"
48 per Pallet



18" x 18" Brick Face
48 per Pallet



24" x 24"
24 per Pallet

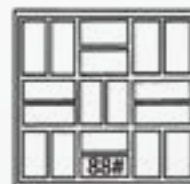

24" x 24" Brick Face
48 per Pallet



12" Round
99 per Pallet



18" Round
48 per Pallet

Available Finishes:

- Fine slip-resistant texture imparted by standard manufacturing process.
- Simulated brick pattern is provided on top surface of certain units as indicated.
- Stock colors are Natural Gray, Red, and Earth Blend
Limited Quantities Available.



TURFSTONE

ECO PAVERS

PRODUCT SPECS

a) Turfstone® Permeable Paver – 15⁵/₈" x 23⁵/₈" x 3¹/₈"

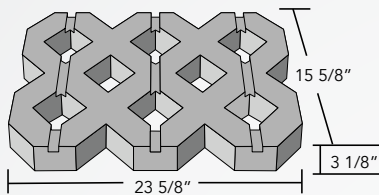

2.667 sq. ft.
70 lbs.
41% open (approx.)
Apertures
3 7/8" x 3 7/8"

Cross Section Typical Residential Installation

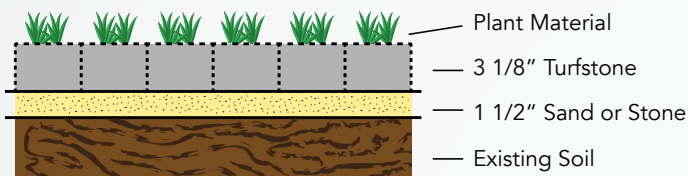

Turfstone and 1 1/2" leveling course after compaction
4000 lbs. per sq. ft. water runoff "C" factor equal 0.25

Cross Section Typical Residential Installation

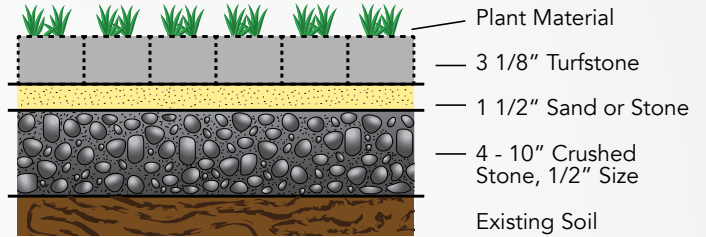

4" thick crushed stone will support 80 lbs. per sq. in.
6" thick crushed stone will support 120 lbs. per sq. in.
10" thick crushed stone will support 160 lbs. per sq. in.

Cross Section Typical Embankment Erosion Control

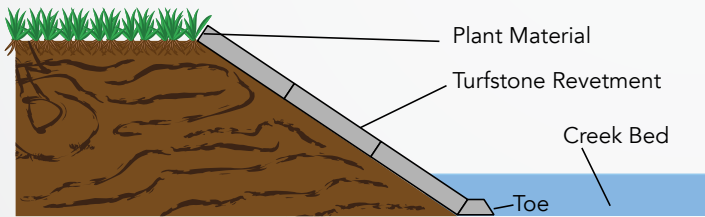

PACKAGING INFO

PRODUCT	WEIGHT PER SQ. FT.	UNITS PER SQ. FT.	UNITS PER BAND	UNITS PER CUBE	WEIGHT PER CUBE	SQ. FT. PER UNIT	SQ. FT. PER BAND	SQ. FT. PER CUBE	COLORS STOCKED
Turfstone® Grass Paver	27.6	0.37	N/A	48	2784	2.667	N/A	128	Gray

RENEWABLE



ECO PAVERS

PRODUCT SPECS

a) **Renewable Paver** – 8⁵/₈" x 8⁵/₈" x 3¹/₈"

APPLICATIONS

Sidewalks, Commercial Parking Lots, Patios, Residential Streets, Courtyards, Driveways and Heavy Vehicular Travel Areas

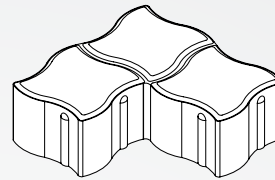

Sandset

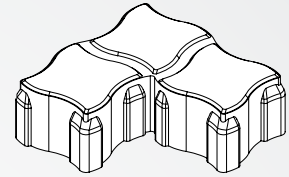

Permeable

CROSS SECTION TYPICAL PERMEABLE PAVER SYSTEM

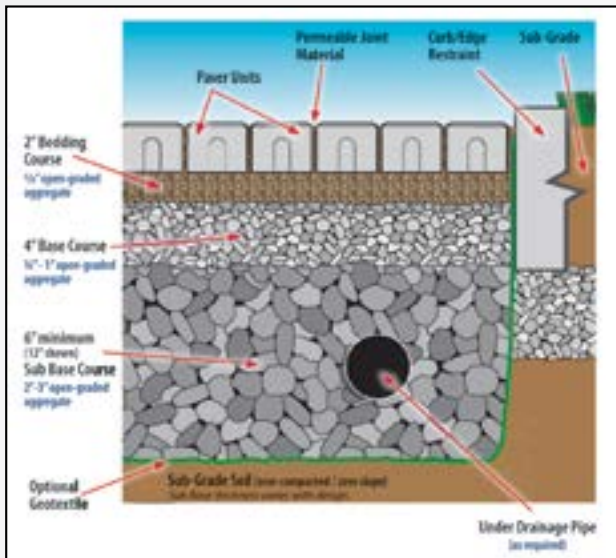

LAYER CONFIGURATION:

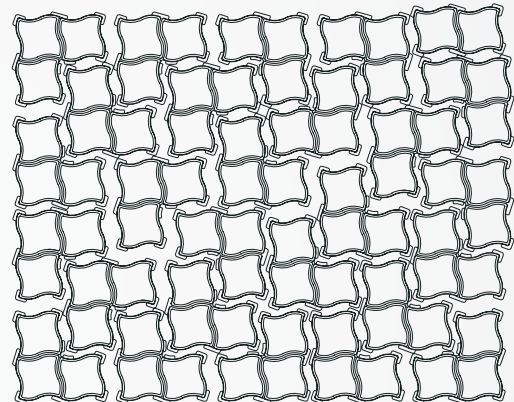

PACKAGING INFO

PRODUCT	SF PER LAYER	LAYERS PER CUBE	WT PER CUBE	SF PER CUBE	COLORS STOCKED
Sandset & Permeable	10	8	2750	80	Non-Stock

Palletized to accommodate mechanical equipment for machine laid applications.

Note: Due to variations in printing, color selections should always be chosen from actual product samples. Textured pavers require a buffer between the plate compactor and paver surface to prevent scuffing.

SPECIAL ORDER SOLID COLORS

Dream



Homecoming



Reflection



Reunion



Traditions



Vision



SPECIAL ORDER BLENDED COLORS

Haven



Oasis



Serenity



Timeless





H₂O Pro

ECO PAVERS

PRODUCT SPECS

- a) **H2O Pro-A** - 4" x 8" x 3/8"
- b) **H2O Pro-B** - 8" x 8" x 3/8"
- c) **H2O Pro-C** - 8" x 16" x 3/8"

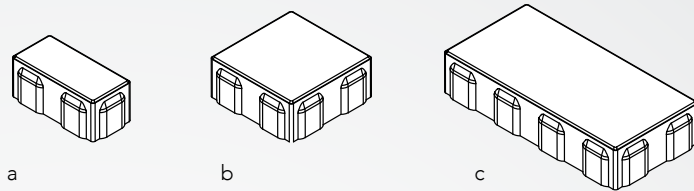

APPLICATIONS

Driveways, patios, residential streets, parking lots, sidewalks, office plazas, traffic calming features, tree planting areas, subdivision roads, outdoor seating areas, parking bays or lanes, redevelopment sites, public spaces and parks

LAYER CONFIGURATION: Pro-A 4" x 8"

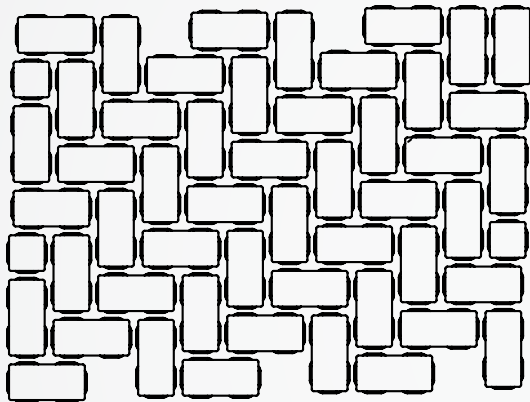

CROSS SECTION TYPICAL PERMEABLE PAVER SYSTEM

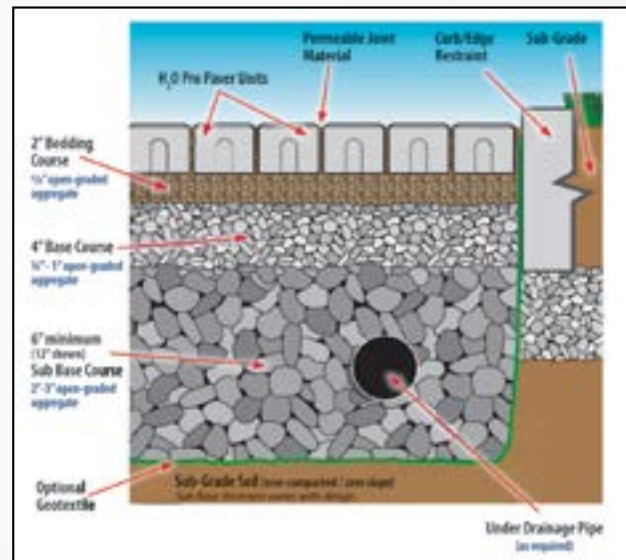

PACKAGING INFO

PRODUCT	SF PER LAYER	LAYERS PER CUBE	WT PER CUBE	SF PER CUBE	COLORS STOCKED
H2O Pro-A	11	8	3395	88	Non-Stock
H2O Pro-B	13.2	8	4070	105.60	Non-Stock
H2O Pro-C	13.2	8	4120	105.60	Non-Stock

H2O Pro-A palletized to accommodate mechanical equipment for machine laid applications.

Note: Due to variations in printing, color selections should always be chosen from actual product samples. Textured pavers require a buffer between the plate compactor and paver surface to prevent scuffing.

SPECIAL ORDER H2O PRO BLENDED

Haven

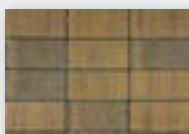

Oasis

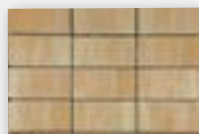

Serenity



Timeless

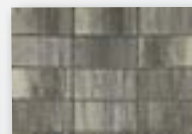

SPECIAL ORDER H2O PRO SOLIDS

Reflection



Vision

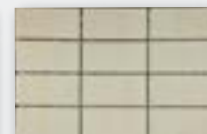

ROSETTA BELVEDERE®



PRODUCT SPECS

Rosetta® Belvedere –

Wall blocks come in different sizes to create a double sided wall

Rosetta® Belvedere also available in corners and copings.

See Belvedere Firepit Kit, Page 45.



Wall Pallet



Corner Pallet



Alternate courses with 6" and 3" blocks. 27" x 27" x 2.25" Column caps also available. Sold separately.

Coping Pallet



APPLICATIONS

Walls or freestanding columns proportionately scaled for residential applications.

INSTALLATION PATTERNS

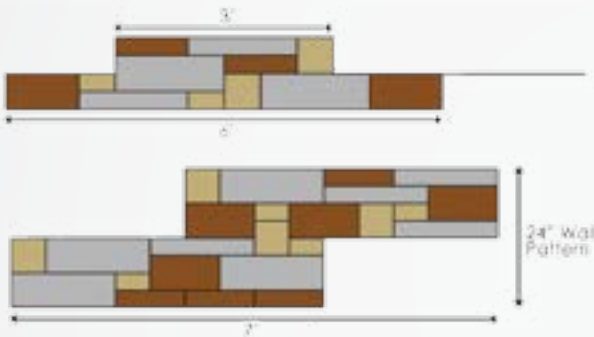

//

BLOCK DETAILS

	STONE & BUNDLING	Unit Dimensions L"xW"xH"	Units/Cube	Weight/Stone lbs.
Wall Pallet	Block 1	6"x9"x3"	12	10±
	Block 2	12"x9"x3"	12	20±
	Block 3	18"x9"x3"	12	36±
	Block 4	6"x9"x6"	12	21±
	Block 5	12"x9"x6"	12	42±
	Block 6	18"x9"x6"	12	67±
Corner Pallet	Block 7	15"x9"x3"	16	30±
	Block 8	15"x9"x6"	16	58±
Coping Pallet	Block 9	6"x10.25"x2.25"	24	10±
	Block 10	12"x10.25"x2.25"	24	20±
	Block 11	18"x10.25"x2.25"	12	30±
	Block 12	18"x10.25"x2.25" (Left End)	6	30±
	Block 13	18"x10.25"x2.25" (Right End)	6	30±
	Belvedere Column Cap	27"x27"x2.25"	10	150±

PACKAGING INFO

PRODUCT	WEIGHT PER SQ. FT.	UNITS PER SQ. FT.	UNITS PER BAND	UNITS PER CUBE	WEIGHT PER CUBE	SQ. FT. PER UNIT	SQ. FT. PER BAND	SQ. FT. PER CUBE	COLORS STOCKED
Rosetta® Belvedere Walls	91.667	N/A	N/A	N/A	2475	N/A	N/A	27.00	Cuyahoga, Mahoning, Scioto
Rosetta® Belvedere Corners	63.33	N/A	N/A	N/A	1520	N/A	N/A	24.00	Cuyahoga, Mahoning, Scioto
Rosetta® Belvedere Coping	N/A	N/A	N/A	N/A	1550	N/A	N/A	66.00/LNFT	Cuyahoga, Mahoning, Scioto

Note: Due to variations in printing, color selections should always be chosen from actual product samples. Textured pavers require a buffer between the plate compactor and paver surface to prevent scuffing.

COLORS

Cuyahoga Blend

Mahoning Blend

Scioto Blend



Coping Pallet

- Pallet weight = ±1,550 lbs (incl. pallet weight)
- Coverage = 66 linear feet per Pallet
- Section = 11 linear feet per 1 layer

Coping blocks are provided in five basic sizes. There are three standard coping blocks which are finished on the front, back, and top faces. The standard coping blocks are tapered approximately 1" on each side from the front to the back of the block. There are also two end units which are finished on front, back, top, and one of the sides. The other side is tapered approximately 1" from the front to the back of the block. The end units are useful for constructing corners and ends. There are multiple face/texture patterns for each basic block size, providing a more random look for your finished project.

Dimensional Coping is also an option for capping the Belvedere Wall. Average block weights of the different face/texture patterns are shown. Weights of individual blocks may vary.



ROSETTA® DIMENSIONAL WALL

RETAINING WALLS

PRODUCT SPECS

- a) Dimensional Wall Straight Block – 12" x 8" x 4"
- b) Dimensional Wall Wedge Block – 12" x 8" x 4"

APPLICATIONS

Garden walls, freestanding walls, columns and edging.



Dimensional Straight Pallet

- 75 pieces / pallet
- 28# / piece
- 2100# / pallet

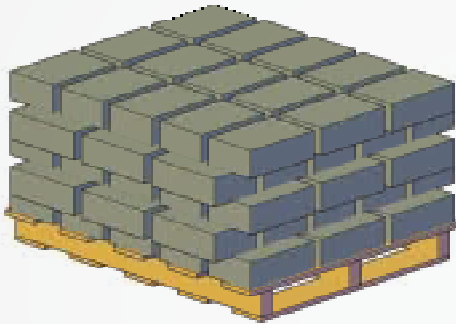

Dimensional Wedge Pallet

- 100 pieces / pallet
- 20# / piece
- 2000# / pallet

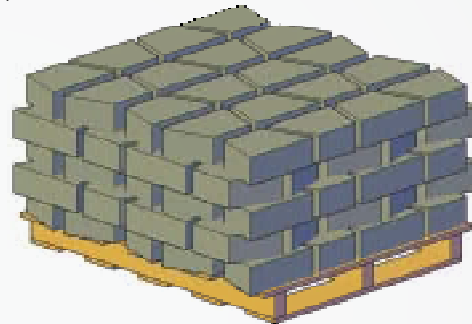

PACKAGING INFO

PRODUCT	WEIGHT PER SQ. FT.	UNITS PER SQ. FT.	UNITS PER BAND	UNITS PER CUBE	WEIGHT PER CUBE	SQ. FT. PER UNIT	SQ. FT. PER BAND	SQ. FT. PER CUBE	COLORS STOCKED
Rosetta® Dimensional Wall	84	3.00	N/A	75	2100	.333	N/A	25.00	Cuyahoga, Mahoning, Scioto
Rosetta® Dimensional Wedge	N/A	3.00	N/A	100	2000	.333	N/A	N/A	Cuyahoga, Mahoning, Scioto

Note: Due to variations in printing, color selections should always be chosen from actual product samples.

COLORS

Cuyahoga Blend



Mahoning Blend



Scioto Blend



ROSETTA® KODAH WALL



PRODUCT SPECS

- a) Kodah Wall – 12" x 10.5" x 6"
 - b) Kodah Wall – 21" x 10.5" x 6"
 - c) Kodah Wall – 30" x 10.5" x 6"
 - d) Kodah Wall – 42" x 10.5" x 6"
 - e) Kodah Wall Corner – 21" x 10.5" x 6"
- } Packaged together



APPLICATIONS

Garden walls, freestanding walls, columns and edging.

INSTALLATION

Engineered Retaining Wall

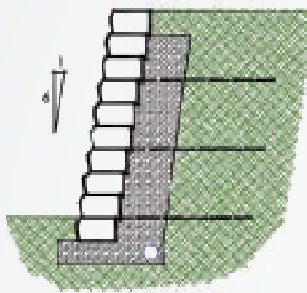

Freestanding Wall

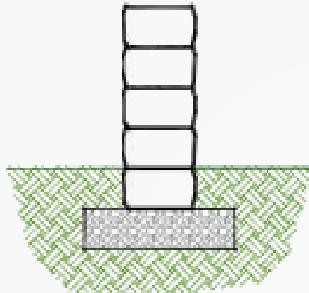

Kodah Freestanding Wall Blocks are provided in four basic sizes. The blocks are finished on both the front and back faces of the wall blocks and they are tapered on each side approximately 1 1/2" from the front to the back of the block. There are multiple texture patterns for each basic block size to provide a more random look for your finished project. Average block weights of the different texture patterns are shown. Weights of individual blocks may vary.

BLOCK DETAILS

STONE & BUNDLING Unit Dimensions L"xW"xH" Units/Cube Weight/Stone lbs.

STONE & BUNDLING	Unit Dimensions L"xW"xH"	Units/Cube	Weight/Stone lbs.	
Freestanding Wall Pallet	Block 1	42"x10.5"x6"	6	200±
	Block 2	30"x10.5"x6"	3	140±
	Block 3	21"x10.5"x6"	6	100±
	Block 4	12"x10.5"x6"	3	50±
Corner Pallet	Block 5	21"x10.5"x6"	16	100±

The Kodah Collection contains two corner blocks. These blocks are finished on three sides, and the fourth side is tapered to fit with the other retaining wall and freestanding wall blocks. The corner blocks can be used to construct columns, provide a finished end on a freestanding wall, and make 90° corners. There are multiple texture patterns for the faces of both corner blocks, thus providing a more random look for your finished project. Average block weights of the different texture patterns are shown. Weights of individual blocks may vary.

PACKAGING INFO

PRODUCT	WEIGHT PER SQ. FT.	UNITS PER SQ. FT.	UNITS PER BAND	UNITS PER CUBE	WEIGHT PER CUBE	SQ. FT. PER UNIT	SQ. FT. PER LAYER	SQ. FT. PER CUBE	COLORS STOCKED
Rosetta® Wall Pallet	N/A	N/A	N/A	18	2400	N/A	N/A	21.00	Cuyahoga, Mahoning, Scioto
Rosetta® Corner Pallet	N/A	N/A	N/A	16	1600	1.3	N/A	21.00	Cuyahoga, Mahoning, Scioto

Note: Due to variations in printing, color selections should always be chosen from actual product samples.

COLORS

Cuyahoga Blend



Mahoning Blend



Scioto Blend



ROSETTA® DIMENSIONAL COPING



RETAINING WALLS

PRODUCT SPECS

- a) **Standard Coping** – 18" x 12.5" x 2.5"
 - b) **Finished End Coping** – 19" x 12.5" x 2.5"
 - c) **Long Coping** – 24" x 12.5" x 2.5"
- } Packaged together

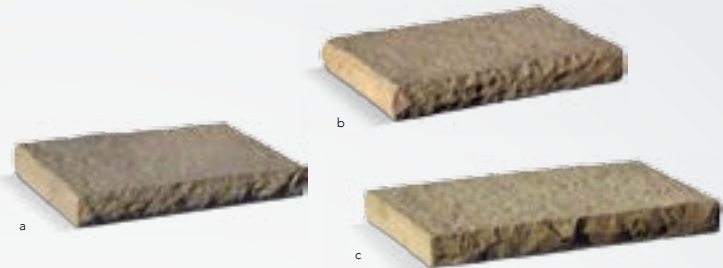

APPLICATIONS

Wall applications.

BLOCK DETAILS

STONE & BUNDLING Unit Dimensions L"xW"xH" Units Bundle Weight/Stone lbs.

Dimensional Coping Pallet	Standard	18"x12.5"x2.5"	12	46±
	Finished End	19"x12.5"x2.5"	6	48±
	Long	24"x12.5"x2.5"	18	61±

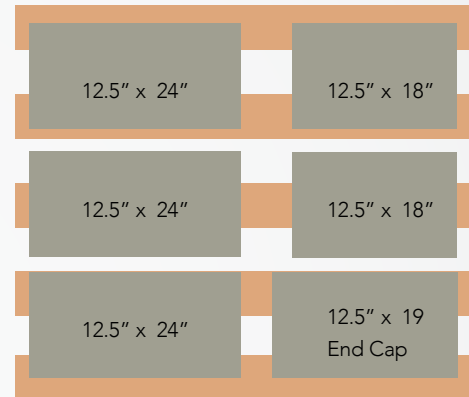

Dimensional Coping Pallet Overview

- 6 layers per pallet
- 63 LF/pallet
- Section = 10.5 LF per 1 layer.

PACKAGING INFO

PRODUCT	WEIGHT PER SQ. FT.	UNITS PER SQ. FT.	UNITS PER BAND	UNITS PER CUBE	WEIGHT PER CUBE	SQ. FT. PER UNIT	SQ. FT. PER BAND	SQ. FT. PER CUBE	COLORS STOCKED
Rosetta® Dimensional Coping	N/A	N/A	N/A	N/A	1950	N/A	N/A	63.00/LNFT	Cuyahoga, Mahoning, Scioto

COLORS

Cuyahoga Blend



Mahoning Blend



Scioto Blend



ROSETTA® OUTCROPPING



PRODUCT SPECS

- a) Rosetta® Outcropping Wall Stone – Recommended Ratio
2 A Pallets
2 B Pallets
1 C Pallet
- b) Rosetta® Outcropping Wall Stone Corner 6"
- c) Rosetta® Outcropping Wall Stone Corner 12"

APPLICATIONS

Residential or commercial engineered wall system.

PATTERNS

Pre-drawn patterns and custom layout software saves time in estimating and installation.

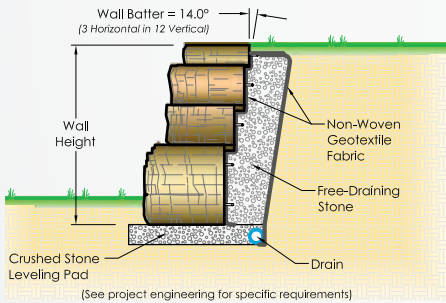
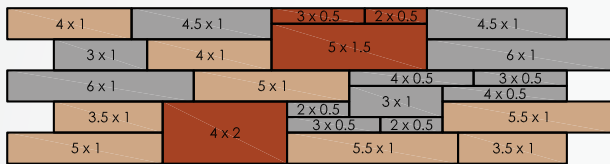

Pallet A: 18 s.f., 4,000 lbs



Pallet B: 18 s.f., 4,000 lbs



Pallet C: 18 s.f., 4,000 lbs



Corner Pallet 6": 4 units, 1920 lbs

Corner Pallet 12": 2 units, 2340 lbs

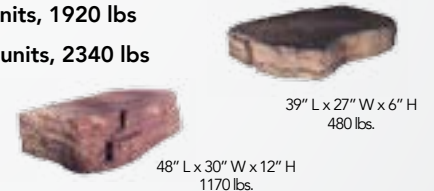

PACKAGING INFO

PRODUCT	WEIGHT PER SQ. FT.	UNITS PER SQ. FT.	UNITS PER BAND	UNITS PER CUBE	WEIGHT PER CUBE	SQ. FT. PER UNIT	SQ. FT. PER BAND	SQ. FT. PER CUBE	COLORS STOCKED
Rosetta® Outcropping	222.22	N/A	N/A	N/A	4000	N/A	N/A	18.00	Cuyahoga, Scioto

COLORS

Cuyahoga Blend



Scioto Blend



Note: Due to variations in printing, color selections should always be chosen from actual product samples.



OLENTANGY BLUFF TREAD

RETAINING
WALLS

PRODUCT SPECS

- a) **Olentangy Bluff Tread™** –
36" L x 16" D x 6" H (280 lbs.)
- b) **Olentangy Bluff Tread™** –
49.5" L x 16" D x 6" H (373 lbs.)
- c) **Olentangy Bluff Tread™** –
60" L x 16" D x 6" H (467 lbs.)
- d) **Olentangy Bluff Tread™** –
72" L x 16" D x 6" H (560 lbs.)



a



b



c



d

APPLICATIONS

Residential or commercial step applications.

PACKAGING INFO

PRODUCT	WEIGHT PER SQ. FT.	UNITS PER SQ. FT.	UNITS PER BAND	UNITS PER CUBE	WEIGHT PER CUBE	SQ. FT. PER UNIT	SQ. FT. PER BAND	SQ. FT. PER CUBE	COLORS STOCKED
Olentangy Bluff Tread 36"	N/A	N/A	N/A	8	2240	N/A	N/A	N/A	Cuyahoga, Hidden Pines, Mahoning, Scioto
Olentangy Bluff Tread 48"	N/A	N/A	N/A	8	2984	N/A	N/A	N/A	Cuyahoga, Hidden Pines, Mahoning, Scioto
Olentangy Bluff Tread 60"	N/A	N/A	N/A	6	2802	N/A	N/A	N/A	Cuyahoga, Hidden Pines, Mahoning, Scioto
Olentangy Bluff Tread 72"	N/A	N/A	N/A	4	2240	N/A	N/A	N/A	Cuyahoga, Hidden Pines, Mahoning, Scioto

COLORS

Cuyahoga Blend

Hidden Pines Blend

Mahoning Blend

Scioto Blend



Note: Due to variations in printing, color selections should always be chosen from actual product samples.

ROSETTA® STEPS



PRODUCT SPECS

a) Rosetta® Irregular Steps

- All irregular steps have 7" rise
- 42" L x 17" D x 7" H (349 lbs.)
 - 42" L x 26" D x 7" H (476 lbs.)
 - 54" L x 22" D x 7" H (458 lbs.)
 - 48" L x 24" D x 7" H (512 lbs.)
 - 48" L x 28" D x 7" H (567 lbs.)
 - 60" L x 24" D x 7" H (600 lbs.)

Packaged
Together

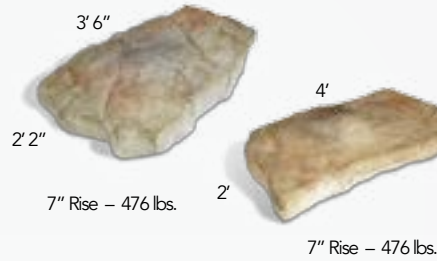
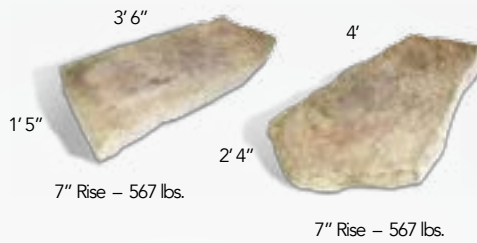

b)



- 36" x 18" x 7"
- 375 lbs/ea
- 6 ea/pallet



- 48" x 18" x 7"
- 455 lbs/ea
- 6 ea/pallet



- 72" x 30" x 7"
- 1320 lbs/ea
- 3 ea/pallet

b) Rosetta® Dimensional Steps

- All dimensional steps have 7" rise
- 36" L x 18" D x 7" H (375 lbs.)
 - 48" L x 18" D x 7" H (455 lbs.)
 - 72" L x 30" D x 7" H (1320 lbs.)

APPLICATIONS

Residential or commercial step applications.

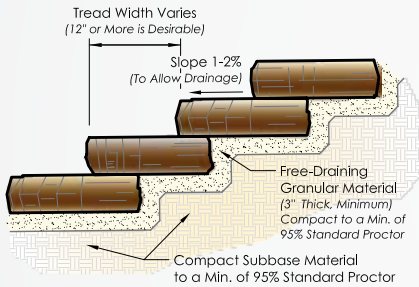

PACKAGING INFO

PRODUCT	WEIGHT PER SQ. FT.	UNITS PER SQ. FT.	UNITS PER BAND	UNITS PER CUBE	WEIGHT PER CUBE	SQ. FT. PER UNIT	SQ. FT. PER BAND	SQ. FT. PER CUBE	COLORS STOCKED
Rosetta® Irregular Steps*	N/A	N/A	N/A	6	3150	N/A	N/A	N/A	Cuyahoga, Hidden Pines, Mahoning, Scioto
Rosetta® Dimensional Steps 3'	N/A	N/A	N/A	6	2250	N/A	N/A	N/A	Cuyahoga, Hidden Pines, Mahoning, Scioto
Rosetta® Dimensional Steps 4'	N/A	N/A	N/A	6	2730	N/A	N/A	N/A	Cuyahoga, Hidden Pines, Mahoning, Scioto
Rosetta® Dimensional Steps 6'	N/A	N/A	N/A	3	3960	N/A	N/A	N/A	Cuyahoga, Hidden Pines, Mahoning, Scioto

COLORS

Cuyahoga Blend

Hidden Pines Blend

Mahoning Blend

Scioto Blend



Due to variations in printing, color selections should always be chosen from actual product samples.



EDINGTON WALL STONE®

RETAINING WALLS

PRODUCT SPECS

- a) Edington Wall Stone® – 12" x 8" x 4"
- b) Edington Wall Stone® Wedge – 12" x 8" x 4"



a



b

APPLICATIONS

Garden walls, freestanding walls, columns and edging with a 3' height maximum.

EDINGTON® FIRE PIT KIT

Build a fire pit in no time with our Edington® Fire Pit Kit. This kit has an outside diameter of 48" and a height of 12". Kit includes a steel metal ring. Optional precast caps are available for a different look at an additional cost. Great for small fires, roasting marshmallows and hot dogs.



PACKAGING INFO

PRODUCT	WEIGHT PER SQ. FT.	UNITS PER SQ. FT.	UNITS PER BAND	UNITS PER CUBE	WEIGHT PER CUBE	SQ. FT. PER UNIT	SQ. FT. PER BAND	SQ. FT. PER CUBE	COLORS STOCKED
Edington Wall Stone®	90	3.00	N/A	120	3600	0.333	N/A	40.00	Canyon Creek, Charcoal, Earth, Flagstone, Quarrystone
Edington Wall Stone® Wedge	75	3.00	N/A	96	2400	0.333	N/A	32.00	Canyon Creek, Charcoal, Earth, Flagstone, Quarrystone

COLORS

Canyon Creek Blend

Earth Blend

Flagstone Blend

Quarrystone

BANDING AND ACCENTS

Charcoal



NON-WEATHERED VERSA-LOK®



RETAINING WALLS

PRODUCT SPECS

- a) **Versa-Lok®** – 16" (face) x 14" (rear) x 12" D x 6" H
- b) **Smooth Top Versa-Lok®** – 16" (face) x 14" (rear) x 12" D x 6" H
- c) **Rectangular Cap** – 16" (face) x 11⁵/₈" D x 3⁵/₈" H
- d) **Bullnose Cap** – 16" (face) x 11⁵/₈" D x 3⁵/₈" H
- e) **Solid Corner** – 7⁷/₈" (face) x 12" D x 6" H
- f) **Full Return Corner** – 16" (face) x 7⁷/₈" D x 6" H

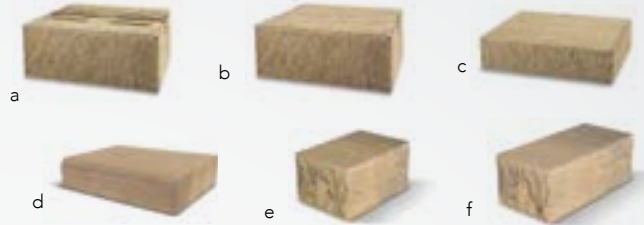

APPLICATIONS

Residential or commercial engineered retaining wall applications.

PACKAGING INFO

PRODUCT	WEIGHT PER SQ. FT.	UNITS PER SQ. FT.	UNITS PER BAND	UNITS PER CUBE	WEIGHT PER CUBE	SQ. FT. PER UNIT	SQ. FT. PER BAND	SQ. FT. PER CUBE	COLORS STOCKED
Non-Weathered Versa-Lok® Standard	123	1.50	N/A	36	2952	0.667	N/A	24.00	Antique, Canyon Creek, Charcoal, Chestnut, Desert Sand, Earth, Flagstone, Granite, Gray
Non-Weathered Versa-Lok® Smooth Top Standard	123	1.50	N/A	36	2952	0.667	N/A	24.00	Antique, Canyon Creek, Charcoal, Chestnut, Desert Sand, Earth, Flagstone, Granite, Gray
Non-Weathered Rectangular Retaining Wall Cap	51	N/A	N/A	60	2880	N/A	N/A	N/A	Antique, Canyon Creek, Charcoal, Chestnut, Desert Sand, Earth, Flagstone, Granite, Gray
Non-Weathered Versa-Lok® Bullnose Cap	51	N/A	N/A	60	2880	N/A	N/A	N/A	Antique, Canyon Creek, Charcoal, Chestnut, Desert Sand, Earth, Flagstone, Granite, Gray
Non-Weathered Versa-Lok® Solid Corner	41	3.00	N/A	72	2952	N/A	N/A	N/A	Antique, Canyon Creek, Charcoal, Chestnut, Desert Sand, Earth, Flagstone, Granite, Gray
Non-Weathered Versa-Lok® Full Return Corner	48	N/A	N/A	54	2592	N/A	N/A	N/A	Antique, Canyon Creek, Charcoal, Chestnut, Desert Sand, Earth, Flagstone, Granite, Gray

COLORS

Antique Blend



Canyon Creek Blend



Charcoal



Chestnut Blend



Desert Sand Blend



Earth Blend



Flagstone Blend



Granite Blend



Gray Blend



Due to variations in printing, color selections should always be chosen from actual product samples.



NON-WEATHERED VERSA-LOK® MOSAIC

RETAINING WALLS

PRODUCT SPECS

- a) **Versa-Lok® Non-Weathered Standard** – 16" (face) x 14" (rear) x 12" D x 6" H
- b) **Versa-Lok® Non-Weathered Cobble** – 8" (face) x 12" D x 6" H
- c) **Versa-Lok® Non-Weathered Accent** – 12" (face) x 12" D x 4" H
- d) **Rectangular Cap** – 16" (face) x 11⁵/₈" D x 3⁵/₈" H
- e) **Bullnose Cap** – 16" (face) x 11⁵/₈" D x 3⁵/₈" H
- f) **Solid Corner** – 7⁷/₈" (face) x 12" D x 6" H
- g) **Full Return Corner** – 16" (face) x 7⁷/₈" D x 6" H

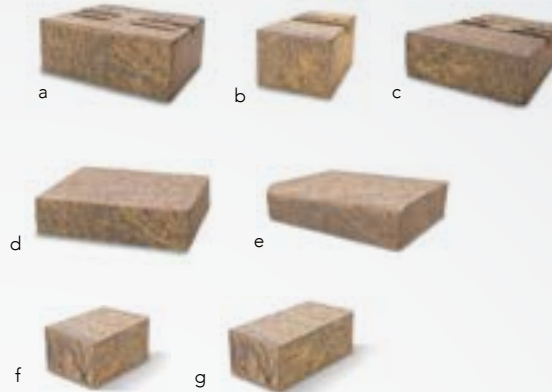

APPLICATIONS

Residential or commercial engineered retaining wall applications.

PACKAGING INFO

PRODUCT	WEIGHT PER SQ. FT.	UNITS PER SQ. FT.	UNITS PER BAND	UNITS PER CUBE	WEIGHT PER CUBE	SQ. FT. PER UNIT	SQ. FT. PER BAND	SQ. FT. PER CUBE	COLORS STOCKED
Non-Weathered Versa-Lok® Standard	123	1.50	N/A	36	2952	0.667	N/A	24.00	Canyon Creek, Earth, Flagstone
Non-Weathered Versa-Lok® Cobble	123	3.00	N/A	72	2952	0.333	N/A	24.00	Canyon Creek, Earth, Flagstone
Non-Weathered Versa-Lok® Accent	123	3.00	N/A	64	2583	0.333	N/A	21.00	Canyon Creek, Earth, Flagstone
Non-Weathered Rectangular Retaining Wall Cap	51	N/A	N/A	60	2880	N/A	N/A	N/A	Canyon Creek, Earth, Flagstone
Non-Weathered Versa-Lok® Bullnose Cap	51	N/A	N/A	60	2880	N/A	N/A	N/A	Canyon Creek, Earth, Flagstone
Non-Weathered Versa-Lok® Solid Corner	41	3.00	N/A	72	2952	N/A	N/A	N/A	Canyon Creek, Earth, Flagstone
Non-Weathered Versa-Lok® Full Return Corner	48	N/A	N/A	54	2592	N/A	N/A	N/A	Canyon Creek, Earth, Flagstone

COLORS

Canyon Creek Blend



Earth Blend



Flagstone Blend





WEATHERED VERSA-LOK® MOSAIC

PRODUCT SPECS

- a) **Versa-Lok® Weathered Standard** – 16" (face) x 14" (rear) x 12" D x 6" H
- b) **Versa-Lok® Weathered Cobble** – 8" (face) x 12" D x 6" H
- c) **Versa-Lok® Weathered Accent** – 12" (face) x 12" D x 4" H
- d) **Weathered Rectangular Cap** – 16" (face) x 11⁵/₈" D x 3⁵/₈" H
- e) **Weathered Bullnose Cap** – 16" (face) x 11⁵/₈" D x 3⁵/₈" H
- f) **Weathered Solid Corner** – 7⁷/₈" (face) x 12" D x 6" H
- g) **Weathered Full Return Corner** – 16" (face) x 7⁷/₈" D x 6" H

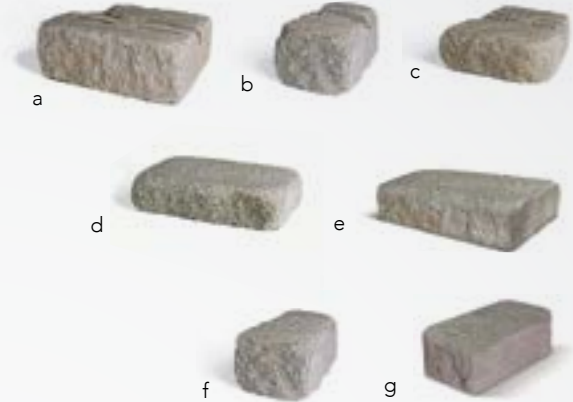

RETAINING WALLS

APPLICATIONS

Residential or commercial engineered retaining wall applications.

PACKAGING INFO

PRODUCT	WEIGHT PER SQ. FT.	UNITS PER SQ. FT.	UNITS PER BAND	UNITS PER CUBE	WEIGHT PER CUBE	SQ. FT. PER UNIT	SQ. FT. PER BAND	SQ. FT. PER CUBE	COLORS STOCKED
Weathered Versa-Lok® Standard	123	1.50	N/A	36	2952	0.667	N/A	24.00	Canyon Creek, Earth, Flagstone
Weathered Versa-Lok® Cobble	123	3.00	N/A	72	2952	0.333	N/A	24.00	Canyon Creek, Earth, Flagstone
Weathered Versa-Lok® Accent	123	3.00	N/A	64	2583	0.333	N/A	21.00	Canyon Creek, Earth, Flagstone
Weathered Rectangular Retaining Wall Cap	51	N/A	N/A	60	2880	N/A	N/A	N/A	Canyon Creek, Earth, Flagstone
Weathered Versa-Lok® Bullnose Cap	51	N/A	N/A	60	2880	N/A	N/A	N/A	Canyon Creek, Earth, Flagstone
Weathered Versa-Lok® Solid Corner	41	3.00	N/A	72	2952	N/A	N/A	N/A	Canyon Creek, Earth, Flagstone
Weathered Versa-Lok® Full Return Corner	48	N/A	N/A	54	2592	N/A	N/A	N/A	Canyon Creek, Earth, Flagstone

COLORS

Canyon Creek Blend



Earth Creek Blend



Flagstone Blend



Due to variations in printing, color selections should always be chosen from actual product samples.



VERSA-LOK® SQUARE FOOT

RETAINING WALLS

PRODUCT SPECS

- a) **Versa-Lok® Square Foot** – 18" (face) x 14" (rear) x 12"D x 8"H
- b) **Square Foot Corner** – 18" (face) x 9"D x 8"H
- c) **18" Retaining Wall Cap** – 18" (face) x 11⁵/₈"D x 3⁵/₈"H

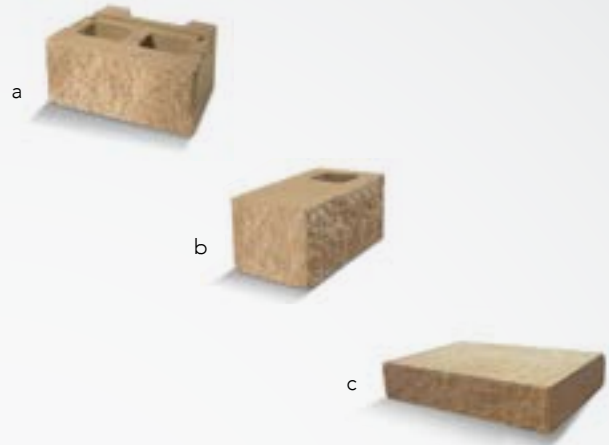

APPLICATIONS

Residential or Commercial,
engineered retaining wall applications

PACKAGING INFO

PRODUCT	WEIGHT PER SQ. FT.	UNITS PER SQ. FT.	UNITS PER BAND	UNITS PER CUBE	WEIGHT PER CUBE	SQ. FT. PER UNIT	SQ. FT. PER BAND	SQ. FT. PER CUBE	COLORS STOCKED
Versa-Lok® Square Foot	87	1.00	N/A	36	3132	1.00	N/A	36.00	Desert Sand, Gray
Square Foot Corner	85	1.00	N/A	36	3060	1.00	N/A	36.00	Desert Sand, Gray
18" Retaining Wall Cap	128	2.19	N/A	40	2336	0.456	N/A	18.24	Desert Sand, Gray

COLORS

Desert Sand



Gray



OMEGA RETAINING WALL SYSTEM™



PRODUCT SPECS

- a) Omega Retaining Wall Straight-Face Unit — 18" front x 12" D x 18" H
- b) Square Foot Corner — 18" (face) x 9"D x 8"H
- c) Omega Retaining Wall Cap — 18" (face) x 11⁵/₈"D x 3⁵/₈"H

APPLICATIONS

Residential or commercial engineered retaining wall applications.
 Omega Retaining Wall System is non-stock. Available in straight-face only.

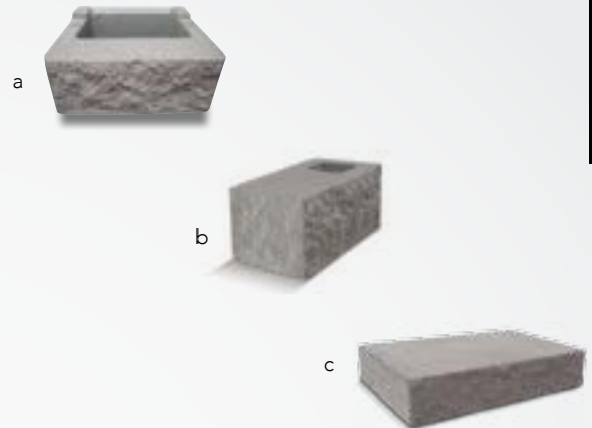

RETAINING WALLS

PACKAGING INFO

PRODUCT	WEIGHT PER SQ. FT.	UNITS PER SQ. FT.	UNITS PER BAND	UNITS PER CUBE	WEIGHT PER CUBE	SQ. FT. PER UNIT	SQ. FT. PER BAND	SQ. FT. PER CUBE	COLORS STOCKED
Omega Retaining Wall System® (Straight-Face)	78	1.00	N/A	32	2496	1.00	N/A	32.00	Non-Stock
Square Foot Corner	85	1.00	N/A	36	3060	1.00	N/A	36.00	Desert Sand, Gray
18" Retaining Wall Cap	128	2.19	N/A	40	2336	0.456	N/A	18.24	Desert Sand, Gray

NON-STOCK COLORS AVAILABLE

Canyon Creek Blend



Earth Blend



Flagstone Blend



Gray Blend

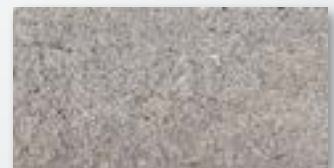

GARDEN-STACK™ WALL



RETAINING WALLS

PRODUCT SPECS

- a) Garden-Stack™ Wall –
12" front x 9" rear x 9"D x 4"H

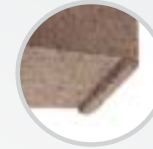

Rear lip for easy alignment and proper set back

APPLICATIONS

Garden walls and tree rings for residential applications.

PACKAGING INFO

PRODUCT	WEIGHT PER SQ. FT.	UNITS PER SQ. FT.	UNITS PER BAND	UNITS PER CUBE	WEIGHT PER CUBE	SQ. FT. PER UNIT	SQ. FT. PER BAND	SQ. FT. PER CUBE	COLORS STOCKED
Garden-Stack® Wall (Straight face)	90	3.00	N/A	96	2880	0.33	N/A	32.00	Antique, Earth, Flagstone

COLORS

Antique Blend



Earth Blend



Flagstone Blend



EDINGTON® FIRE PIT KIT



OVERALL DIMENSIONS

12" H x 48" Diameter

KIT COMPONENTS

- 39 Edington Wall Stone Wedge Units
- 3 - 10 oz. Tubes of Paver Bond
- Steel Ring
- Optional Grill Grate

Build a fire pit in no time with our Edington Fire Pit Kit. Place base units on 4-6" of prepared compacted base and adhere units as you construct. Great for small fires, roasting marshmallows and hot dogs.

RETAINING
WALLS



COLORS

Canyon Creek Blend



Earth Blend



Flagstone Blend



Quarry Stone Blend



PRECAST ROCKFACE CAP COLORS

Cuyahoga Blend



Mahoning Blend



Scioto Blend



Due to variations in printing, color selections should always be chosen from actual product samples.

BELVEDERE® FIREPIT KIT



KITS

OVERALL DIMENSIONS

14" H x 60" Diameter

The Belvedere Fire Pit creates a rustic sophistication all its own. The Belvedere Fire Pit has a diameter of approximately five feet and a height of fourteen inches, the proportions of the fire pit creates a perfect focal point for any occasion—from intimate gathers to larger events. The Belvedere Fire Pit blends seamlessly with the entire collection of attractive Rosetta® paver and wall lines. Kit includes steel metal ring.

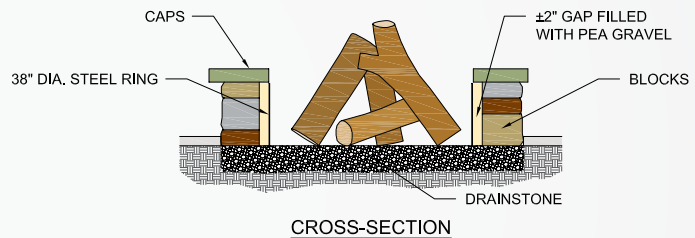
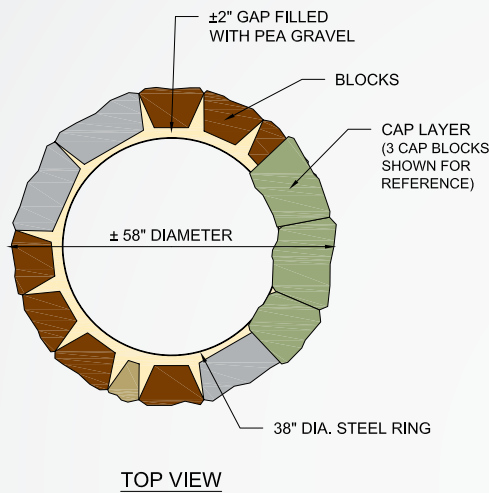

SAMPLE BLOCK LAYOUT PATTERN (OPTIONAL)

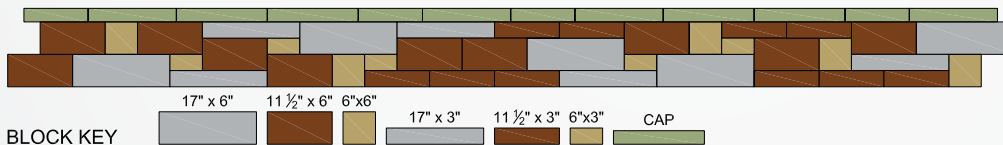

COLORS

Cuyahoga Blend



Mahoning Blend



Scioto Blend



EDINGTON® FIREPLACE KIT

OVERALL DIMENSIONS

98" H x 60" W x 52" D

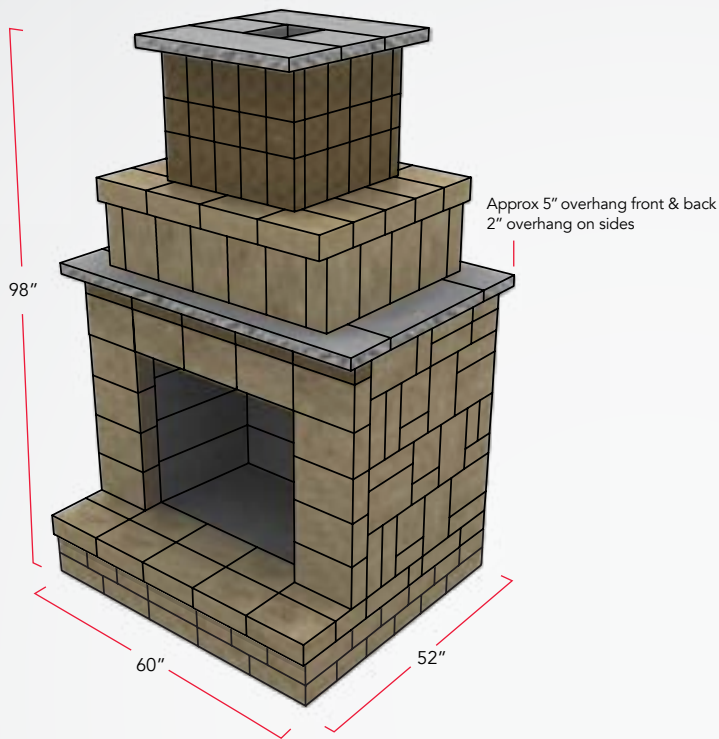

KITS

The Edington Fireplace Kit has everything you need to create a stunning focal point to your outdoor living space. With 3 color options that coordinate with the Washington pavers, your fireplace will be a cozy, beautiful addition to any hardscape.

COLOR OPTION 1



Canyon Creek Blend
Edingtons



Canyon Creek Blend
Vintage Washingtons



Cuyahoga Blend Mantle

COLOR OPTION 2



Earth Blend
Edingtons



Earth Blend
Vintage Washingtons



Cuyahoga Blend Mantle

COLOR OPTION 3



Flagstone Blend
Edingtons



Flagstone Blend
Vintage Washingtons



Scioto Blend Mantle

Due to variations in printing, color selections should always be chosen from actual product samples.

EDINGTON® PUB TABLE KIT



KITS

OVERALL HEIGHT
42"

KIT COMPONENTS

- 36 Edington Wall Stone pieces
- 1-42" Table Top with 2" hole
- 1-28" Foot Rest with 2" hole
 - Both pieces 3" thick
 - The 2" hole fits standard umbrella (not incl.)
- 2-10 oz. Tubes of Paver Bond
- Optional 42" Round Table Top with 2" hole (non stock)

Add additional entertaining space with our Pub Table Kit. The large table top allows plenty of room to enjoy drinks or a snack. The bottom foot rest is great for propping up your feet. We've chosen to stock 3 of our Edington Wall Stone colors to complement your outdoor living space!



COLORS

Canyon Creek Blend



Earth Blend



Flagstone Blend



Quarrystone Blend



PRECAST ROCKFACE CAP COLORS

Cuyahoga Blend



Mahoning Blend



Scioto Blend



EDINGTON® GRILL KIT



OVERALL DIMENSIONS

38" H x 102" W x 32" D

KIT COMPONENTS

- 1 Three-Burner Built-In Grill
- Grill Doors
- 190 Edington Wall Stone Units
- 1 Precast Counter Top
- 1 Case of Paver Bond
- 1 Steel Lintel 40"

Ideal for advanced installers that would like to create a professional outdoor grilling station. Constructed from our popular Edington Wall Stone units, this kit allows you to drop in the included grill, for a clean and professional grill station. The kit is large enough to both cook and entertain guests at.

PRECAST COUNTERTOP COLORS

Cuyahoga Blend



Mahoning Blend



Scioto Blend



COLORS

Canyon Creek Blend



Earth Blend



Flagstone Blend



Quarrystone Blend



Due to variations in printing, color selections should always be chosen from actual product samples.

EDINGTON® WATER FEATURE KIT



OVERALL DIMENSIONS

3' H x 8' W x 4'6" D

KIT COMPONENTS

- 149 Edington Standard Units
- 40 Edington Wedge Units
- 1-24" Colorfalls Kit
- 4-10 oz. Tubes of Paver Bond

Add the calming sound of water to your outdoor space by using the Edington Water Feature Kit. Flanked by two planter columns, the water feature is constructed from our Edington Wall Stone units to compliment your corresponding Edington walls.

COLORS

Canyon Creek Blend



Earth Blend



Flagstone Blend



Quarystone Blend



FIREROCK® FIREPLACES



QUICK INSTALLATION

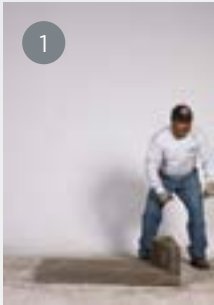

1
Set base plate on non-combustible foundation.



2
Place centerbacks along rear of base plate and build smoke chamber.



3
Install firebrick and fireplace is complete.

FireRock® is a simple way to build a high-end, all masonry outdoor fireplace and chimney. This smartly designed system installs in a matter of hours for less than half the cost of a traditional brick and mortar fireplace. And it enhances the value of any outdoor living space.

Model	Overall Height	Overall Depth	Overall Width	Overall Diameter	Firebox Opening Height	Smoke Chamber Height	Weight in Pounds
30" Outdoor Fireplace	76.63"	28.5"	38"	n/a	29.38"	23"	1900
36" Outdoor Fireplace	84.75"	28.5"	44"	n/a	38"	23"	2100
42" Outdoor Fireplace	106.13"	28.5"	50"	n/a	38"	32.5"	2600
36" Arched Front Outdoor Fireplace	84.75"	28.5"	44"	n/a	34"*	23"	2160
42" Arched Front Outdoor Fireplace	106.13"	28.5"	50"	n/a	34"*	32.5"	2670

*Measurement at top of arch.

** Height Extension Kit adds 6 inches to overall height. The kit also adds 320-1512 lbs depending on the width of the FireRock.

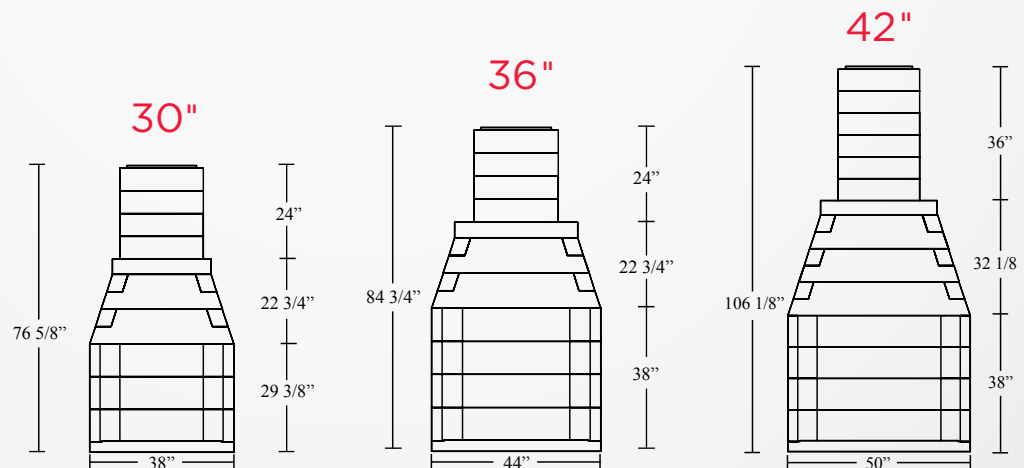

STRATFORD STONE[®]

VENEER STONE

LIMESTONE COLORS

Arizona



Chateau



Delaware



Navajo



Add the instant warmth of stone to your interior or exterior space with our Stratford Stone.[®] This manufactured stone is crafted from molds that replicate the nuances of natural stone. The natural color palette exudes a warmth and richness to any project. Each style of stone conveys a distinct shape, color and style suitable for any application. Ideal for commercial applications, house facades, interior accent walls, fireplaces, outdoor kitchens and pizza ovens.

RUSTIC LEDGESTONE COLORS

Arizona



Chateau



Navajo



STACKED STONE COLORS

Arizona



Chateau

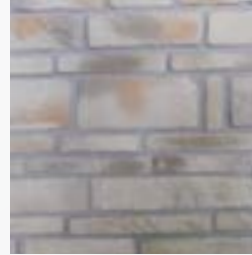

Navajo



MONROE[®] PAVERS & UNITY PAVERS

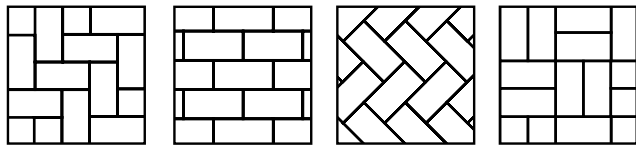

90° Herringbone Running Bond 45° Herringbone Basketweave

WASHINGTON[®] & VINTAGE WASHINGTON PAVERS

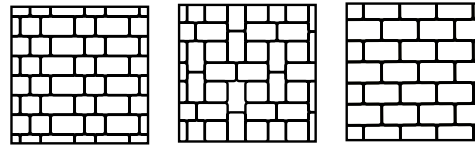

Muster D
40% Wash. 14
60% Wash. 21

Muster K
28% Wash. 14
72% Wash. 21

Running Bond
10, 14, or 21

VINTAGE BELHAVEN[®] PAVERS

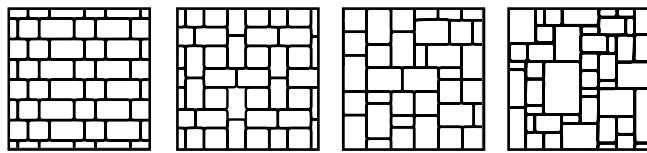

Muster D
40% Small Sq.
60% Standard Rec.

Muster K
28% Small Sq.
72% Standard Rec.

3 Piece Random*
51% Standard Rec.
11% Small Rec.
38% Small Sq.

6 Piece Random*
29% Jumbo Rec.
17% Large Rec.
18% Standard Rec.
7% Small Rec.
18% Large Sq.
11% Small Sq.

TRANQUILITY PAVERS



Pattern 1 Pattern 2

GRAND MILESTONE PAVERS

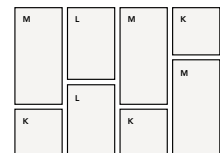

Pattern 1

GRAND LIFESTYLE PAVERS

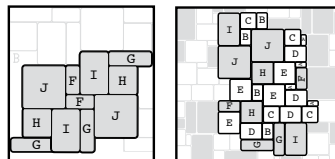

Pattern 1

Pattern 2
Combination Lifestyle
& Grand Lifestyle

DESTINATION PAVERS

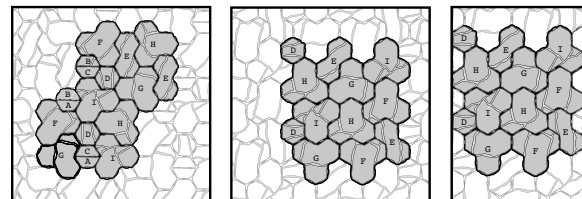

Pattern 1 Pattern 2 Sidewalk Pattern

FLINT RIDGE[®] & VINTAGE FLINT RIDGE PAVERS

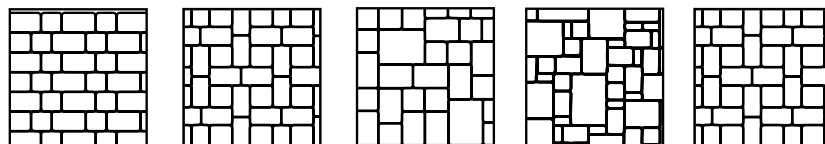

Muster D
40% Small Sq.
60% Standard Rec.

Muster K
28% Small Sq.
72% Standard Rec.

3 Piece Random*
21% Large Rec.
46% Standard Rec.
33% Small Sq.

6 Piece Random*
30% Jumbo Rec.
18% Large Rec.
20% Standard Rec.
19% Large Sq.
13% Small Sq.

Jumbo Muster K
28% Large Sq.
72% Jumbo Rec.

BANAS STONES[®] PAVERS

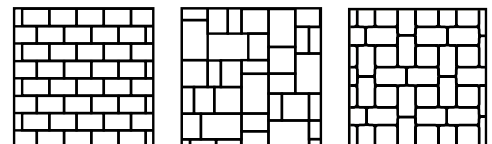

Running Bond
11.81" x 23.62",
17.72" x 23.62", or
23.62" x 35.43"

4 Piece Random
25% 11.81" x
23.62"
30% 17.72" x
23.62"
25% 23.62" x
35.43"
20% 23.62" x
23.62"

Jumbo Muster K
28% Large Sq.
72% Jumbo Rec.

* All random lays are not a pattern. Random lays can consist of any grouping of the pavers.

WASHINGTON CIRCLE[®] PAVERS DIAGRAM

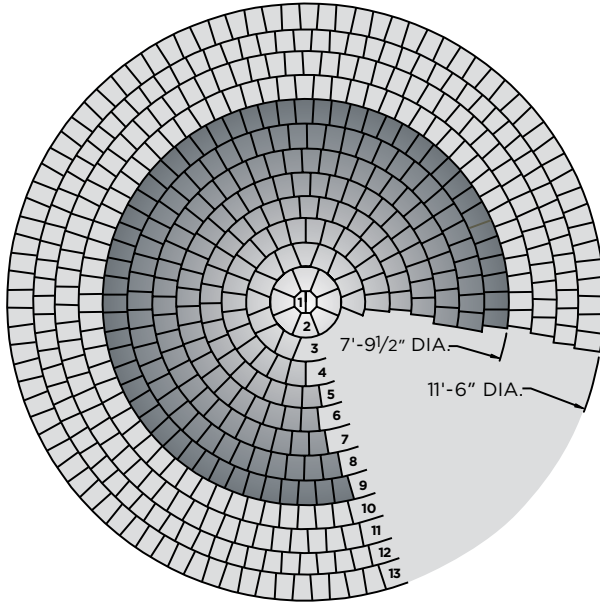

	Row	Circle Dia.	Installation Pattern	Paver Description - Washington [®] Series
First Circle Pack	1	5 1/2"	Single	2-Washington Circle Center
	2	16 1/2"	Single	8-Washington Large Circle
	3	27 1/2"	Alternate	8-Washington Large Circle & 8-Washington
	4	38 1/2"	Single	26-Washington Small Circle
	5	49 1/2"	Single	33-Washington Small Circle
	6	60 1/2"	Single	42-Washington Small Circle
	7	71 1/2"	Alternate	25-Washington Small Circle & 25-Washington 10
	8	82 1/2"	Alternate	29-Washington Small Circle & 29-Washington 10
	9	93 1/2"	Alternate	34-Washington Small Circle & 34-Washington 10
Second Circle Pack	10	104 1/2"	Alternate	38-Washington Small Circle & 38-Washington 10
	11	115 1/2"	Alternate	42-Washington Small Circle & 42-Washington 10
	12	127"	Alternate	46-Washington Small Circle & 46-Washington 10
	13	138"	Alternate	50-Washington Small Circle & 50-Washington 10
Additional Pieces	14 & Up		Single	(As Needed) Washington 10 (81 pcs or 12.78 ft ² per pallet band)
Notes	Outside row may require additional Washington 10's, depending on how it is installed. Number of units per row is an approximate based on installation. Due to the complex shapes of the pieces in a circle, there will be some extra pieces not used for standard installation. As shown above, additional pieces may be needed for diameters large than 8' Oberfields Edington Wedge Firepit Kits fits at 5th row, for installation, omit rows 1-5			

BELHAVEN CIRCLE[®] PAVERS DIAGRAM (SPECIAL ORDER ONLY)

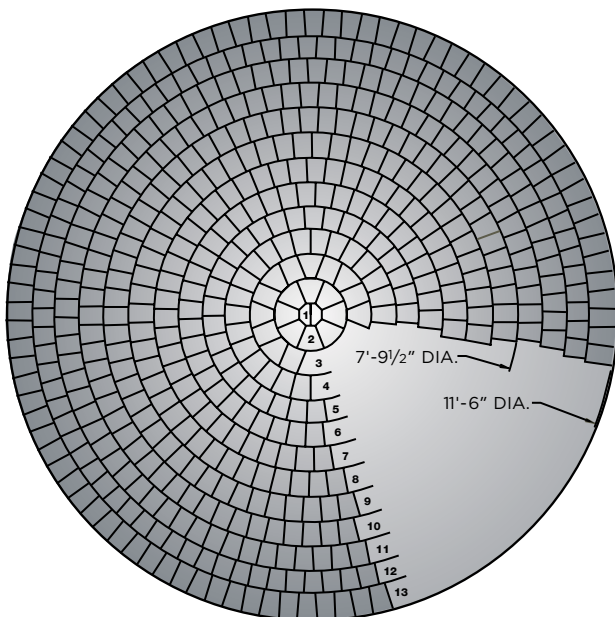

	Row	Circle Dia.	Installation Pattern	Paver Description - Belhaven [®] Series
Circle Pack	1	5 1/2"	Single	1-Belhaven Circle Center
	2	16 1/2"	Single	8-Belhaven Large Circle
	3	27 1/2"	Alternate	8-Belhaven Large Circle & 8-Belhaven Rectangle Paver
	4	38 1/2"	Single	26-Belhaven Small Circle
	5	49 1/2"	Single	33-Belhaven Small Circle
	6	60 1/2"	Single	42-Belhaven Small Circle
	7	71 1/2"	Alternate	25-Belhaven Small Circle & 25-Belhaven Rectangle Paver
	8	82 1/2"	Alternate	29-Belhaven Small Circle & 29-Belhaven Rectangle Paver
	9	93 1/2"	Alternate	34-Belhaven Small Circle & 34-Belhaven Rectangle Paver
	10	104 1/2"	Alternate	38-Belhaven Small Circle & 38-Belhaven Rectangle Paver
	11	115 1/2"	Alternate	42-Belhaven Small Circle & 42-Belhaven Rectangle Paver
	12	127"	Alternate	46-Belhaven Small Circle & 46-Belhaven Rectangle Paver
	13	138"	Alternate	50-Belhaven Small Circle & 50-Belhaven Rectangle Paver
Additional Pieces	14 & Up		Single	(As Needed) Belhaven Small Square Paver
Notes	Number of units per row is approximate based on installation. Due to the complex shapes of the pieces in a circle, there will be some extra pieces not used for standard installation. Oberfields Edington Wedge Firepit Kit fits at 5th row, for installation, omit rows 1-5. To reach the dimension of 11'6" diameter, some of the required pieces are going to come from the first circle pack.			

MONROE



Antique Blend

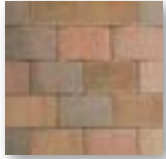

Autumn Blend

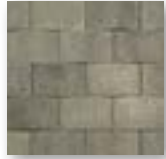

Granite Blend

WASHINGTON



Antique Blend

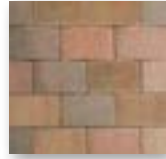

Autumn Blend

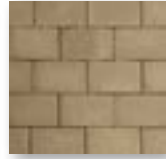

Desert Sand (14's only)

WASHINGTON CIRCLE

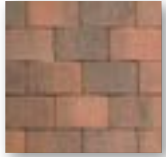

Antique Blend

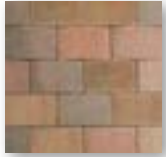

Autumn Blend

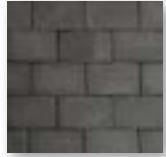

Charcoal

VINTAGE WASHINGTON



Vintage Antique Blend



Vintage Charcoal (14's only)



Vintage Desert Sand Blend (14's only)



Vintage Granite Blend

VINTAGE BELHAVEN CIRCLE



Vintage Canyon Creek Blend



Vintage Earth Blend



Vintage Flagstone Blend

TRAVERTINE

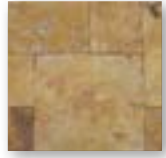

Gold



Greige



Silver

SILEX



Arena



Grafito

IRONWOOD



Bambú



Ciprés

ROSETTA GRAND FLAGSTONE



Hidden Pines Blend



Mahoning Blend

ROSETTA DIMENSIONAL FLAGSTONE

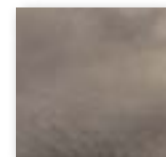

Hidden Pines Blend

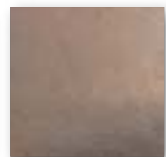

Mahoning Blend

UNITY smooth solid



Dream

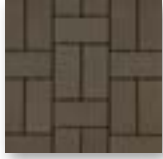

Homecoming



Reflection



Reunion



Traditions



Vision

UNITY smooth blended

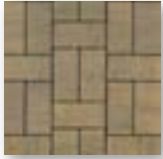

Haven

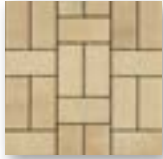

Oasis



Serenity

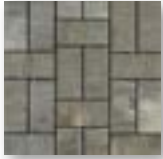

Timeless

UNITY tumbled solid



Dream-Tumbled



Homecoming-Tumbled



Reflection-Tumbled



Reunion-Tumbled



Traditions-Tumbled



Vision-Tumbled

UNITY tumbled blended



Haven-Tumbled



Oasis-Tumbled



Serenity-Tumbled



Timeless-Tumbled

UNITY hammered



Dream-Hammered

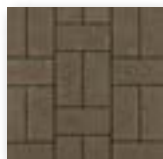

Homecoming-Hammered



Reflection-Hammered



Reunion-Hammered



Vision-Hammered

RENEWABLE solids



Dream Homecoming Reflection Reunion



Traditions Vision

RENEWABLE blended



Haven Oasis Serenity Timeless

H2O PRO solids

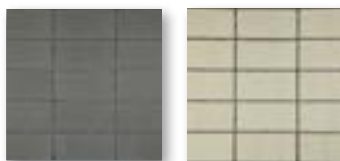

Reflection Vision

H2O PRO blended



Haven Oasis Serenity Timeless

EDINGTON WALL STONE



Autumn Fieldstone Sierrastone

**NON-WEATHERED
VERSA-LOK**



Brown

**NON-WEATHERED
VERSA-LOK MOSAIC**



Chestnut Blend Granite Blend

**WEATHERED
VERSA-LOK MOSAIC**



Chestnut Blend Granite Blend

**BELVEDERE/DIMENSIONAL WALL/
KODAH / DIMENSIONAL COPING**

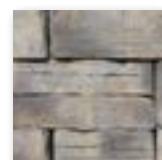

Hidden Pines
Blend

OUTCROPPING

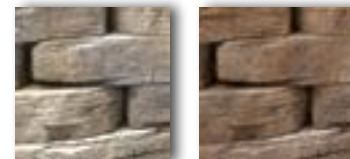

Hidden Pines
Blend Mahoning
Blend



OBERFIELDS SALES - CORPORATE OFFICE

Masonry, Landscape & Precast

528 London Road
P.O. Box 362
Delaware, Ohio 43015-0362
614-252-0955
740-369-7644
800-845-7644
Fax 740-363-7644

SALES AND MANUFACTURING

Landscape & Precast

1165 Alum Creek Drive
Columbus, Ohio 43209
614-252-0955
Fax 614-252-5858

Masonry & Landscape

10075 Sheehan Road
Centerville, OH 45458
937-885-3711
Fax 937-885-4355

