



WHAT OUTDOOR LIVING SHOULD BE

oberfields.com





INSPIRATION

What Outdoor Living Should Be® 2-3

PAVERS

Flat Top Washington® 6-7
 Vintage Flat Top Washington® 8-9
 Lexington® 10-11
 Lexington Circle® 12-13
 Plymouth® 14-15
 Malibu® 16-17
 Ozark® 18-19
 Manhattan® 20-21
 Newport® 22-23
 Jamestown® 24-25
 Bullnose 26-27
 Rosetta® Grand Flagstone 28-29
 Rosetta® Dimensional Flagstone 30-31
 Natural Stone 32-33
 Natural Stone Accessories..... 34-35
 Travertine 36-37
 Porcelain..... 38-39
 Rosetta® Superior Steppers 40-41

RETAINING WALLS

Rosetta® Belvedere..... 44-45
 Rosetta® Dimensional 46-47
 Rosetta® Kodah..... 48-49
 Rosetta® Dimensional Coping 50-51
 Rosetta® Outcropping 52-53
 Olentangy Bluff Tread™ 54-55
 Rosetta® Steps..... 56-57
 Edington Wall Stone®..... 58-59
 Non-Weathered Versa-Lok® 60-61
 Non-Weathered Versa-Lok® Mosaic® 62-63
 Weathered Versa-Lok® Mosaic® 64-65

GENERAL INFORMATION

Kits 66-68
 Special Order Colors..... 69
 FireRock® Fireplaces 70
 Dura Denz® Sealer..... 71
 Column Caps 72
 Fireplaces & Fire Pits..... 73
 Kichler. Lighting..... 74
 Berlin Gardens' Structures & Furniture..... 75
 Paver Patterns 76-77
 Packaging Reference Guide..... 78-81
 Warranty 82-83



NEW ALL-IN-ONE SEALER

How do you go about keeping your new paver project looking its absolute best? By sealing it with a Dura Denz All-In-One Penetrating Sealer, uniquely formulated in conjunction with the Americana Collection pavers to enhance, protect, and stabilize your paver project for years to come. Visit page 71 and learn more about the new Dura Denz difference maker!

SEE THE DIFFERENCE.
FEEL THE DIFFERENCE.
DESIGN TO BE DIFFERENT.

Dura Denz represents a dramatic break-through in concrete casting technology. Our new world-class manufacturing process results in exceptional products that are infused with Dura Denz Technology. A specially formulated dense top layer creates a smooth, extra-hard surface that resists chipping, scratching and fading. The result is products that are not only beautiful, but extremely durable. Exceed your clients expectations when you feature products manufactured with Dura Denz Technology. Quite frankly, it's unlike anything you'll find on the market.



AMERICANA



COLLECTION

INTRODUCING



Standard concrete pavers are coarse with visible aggregate on surface. They are manufactured to exceed all ASTM standards for quality and strength.

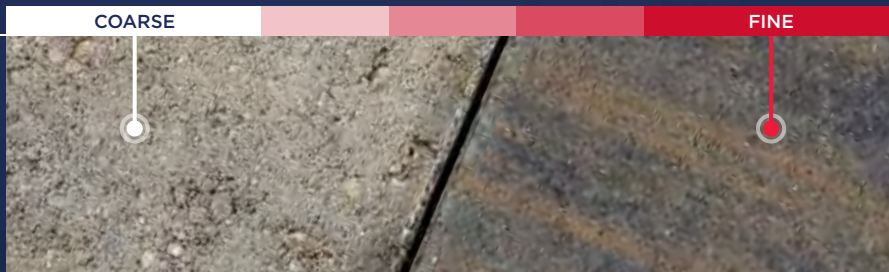

Dura Denz Technology provides an exceptional paver with color infused throughout and a top layer that's colorfast and resilient to wear and tear. ASTM compliant.



EXTREMELY DURABLE
RESISTS DAILY WEAR AND TEAR



TINTED THROUGHOUT
(INDUSTRY EXCLUSIVE)



COLOR FADE RESISTANT



DENSE TOP-LAYER
(NO COARSE AGGREGATE)



EXCEEDS ASTM STANDARDS
ENHANCED QUALITY AND STRENGTH



AMERICAN OWNED AND MADE



WHAT OUTDOOR LIVING SHOULD BE[®]

Let us be your one-stop
source for outdoor living.

PAVERS
WALLS
LIGHTING
SEALERS



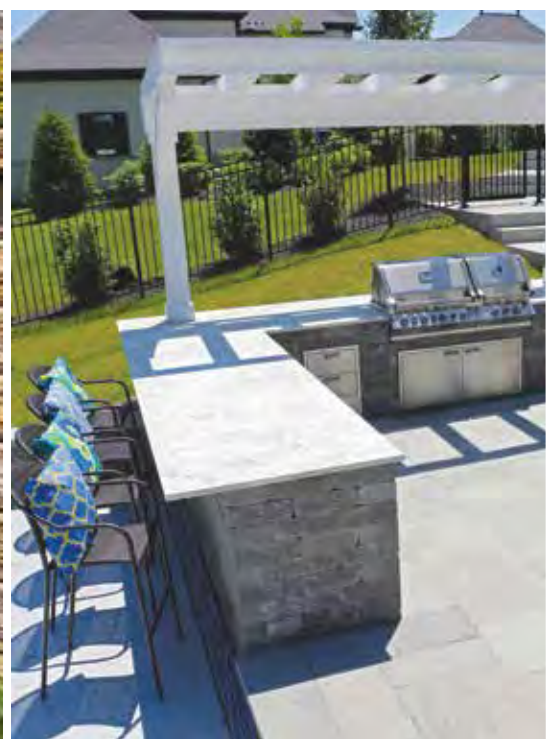



LASTING MEMORIES
HAPPEN HERE.



FLAT TOP WASHINGTON®
VINTAGE FLAT TOP WASHINGTON®

LEXINGTON®
LEXINGTON CIRCLE®
PLYMOUTH®
MALIBU®
OZARK®
MANHATTAN®
NEWPORT®
JAMESTOWN®

AMERICANA COLLECTION®

BULLNOSE
ROSETTA® GRAND FLAGSTONE
ROSETTA® DIMENSIONAL FLAGSTONE
NATURAL STONE
NATURAL STONE ACCESSORIES
TRAVERTINE
PORCELAIN
ROSETTA® SUPERIOR STEPPERS



FLAT TOP WASHINGTON®

Our Flat Top Washington® pavers are just that...flat top, with squared off corners of both square and rectangle units. Similar in size to our old Washington pavers, these Flat Top Washington's have no "pillowtop" appearance. They are a cleaner, more modern look on one of our classic pavers. Flat Top Washington's do not feature Dura Denz Technology.



PRODUCT SPECS

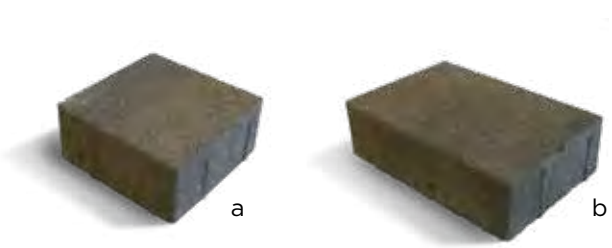

- a) Flat Top Washington® 14 - $5\frac{1}{2}'' \times 5\frac{1}{2}'' \times 2\frac{3}{8}''$
- b) Flat Top Washington® 21 - $5\frac{1}{2}'' \times 8\frac{1}{4}'' \times 2\frac{3}{8}''$

COLORS



Canyon Creek Blend



Charcoal



Desert Sand (21's only)



Earth Blend



Flagstone Blend



Granite Blend



VINTAGE FLAT TOP WASHINGTON®

Like your favorite broken in jeans, our Vintage Flat Top Washington® pavers capture a time-worn appearance. This collection of tumbled pavers are a spin-off of our Flat Top Washington's, reflecting a more muted color palette with tumbled corners to create a more rustic, weathered look. Vintage Flat Top Washington's do not feature Dura Denz® technology.

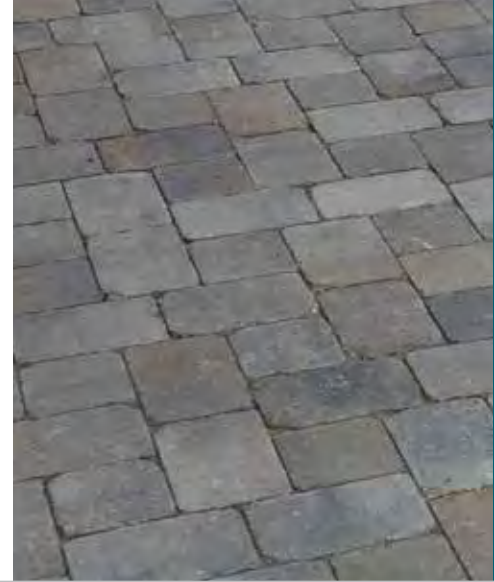

PRODUCT SPECS



- a) **Vintage Flat Top Washington® 14** - $5\frac{1}{2}'' \times 5\frac{1}{2}'' \times 2\frac{3}{8}''$
- b) **Vintage Flat Top Washington® 21** - $5\frac{1}{2}'' \times 8\frac{1}{4}'' \times 2\frac{3}{8}''$

COLORS



Vintage Canyon
Creek Blend



Vintage Charcoal



Vintage Desert Sand
(21's only)



Vintage Earth Blend



Vintage Flagstone Blend



Vintage Granite Blend



LEXINGTON[®]



Classic cobblestone patterns with squares and rectangles, convey the southern charm that make our Lexington pavers a beautiful, simple statement to any outdoor space. Incorporate a Lexington Circle to define seating areas or fire pits.

PRODUCT SPECS

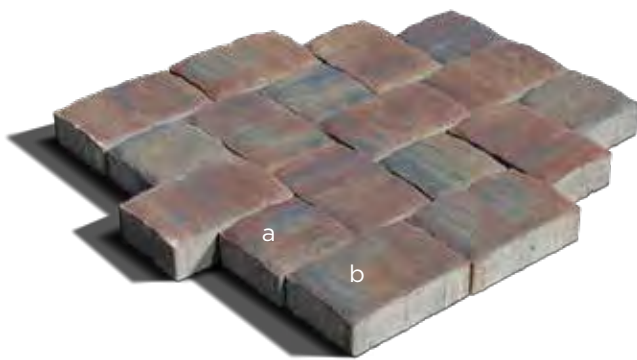

- Lexington 10:** $4 \frac{1}{8}'' \times 5 \frac{1}{2}'' \times 2 \frac{3}{8}''$
- a) **Lexington 14:** $5 \frac{1}{2}'' \times 5 \frac{1}{2}'' \times 2 \frac{3}{8}''$
- b) **Lexington 21:** $5 \frac{1}{2}'' \times 8 \frac{1}{4}'' \times 2 \frac{3}{8}''$



COLORS



Canyon Creek Blend

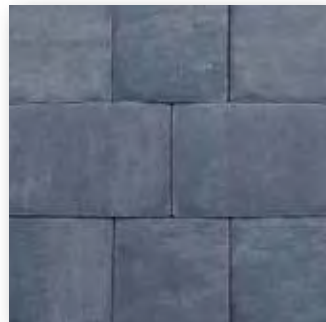

Charcoal



Desert Sand



Earth Blend

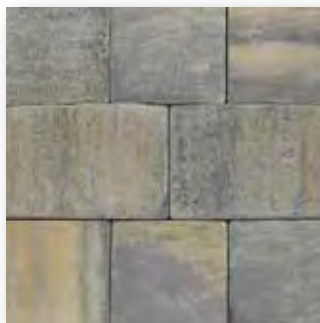

Flagstone Blend

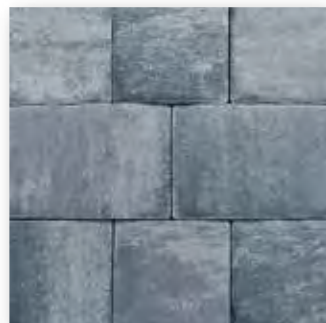

Granite Blend



LEXINGTON CIRCLE[®]



Define a seating area or fire pit with our Lexington Circle. Made to compliment our Lexington pavers, the circle kit adds style and design to make for a more interesting outdoor space.



PRODUCT SPECS

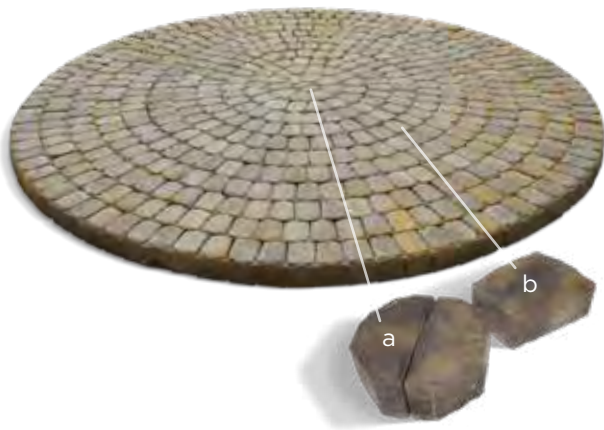

a) **Lexington Circle** - Circle center, small circle paver, large circle paver, Lexington 10's

b) **Lexington 10** - $4 \frac{1}{8}'' \times 5 \frac{1}{2}'' \times 2 \frac{3}{8}''$

Must add layer of Lexington 10s to fill out a 11'6" circle.

COLORS



Canyon Creek Blend



Desert Sand



Earth Blend



Flagstone Blend



Granite Blend



PLYMOUTH[®]



A different take on your classic brick shape appearance. Our Plymouth paver size adds contrast to various field pavers. Ideal for bordering, it's often used in a contrasting color or as an inlay detail.



PRODUCT SPECS



a) **Plymouth** - 4" x 8" x 2 ³/₈"

*All Plymouth pavers sold by the layer or cube, not by the piece.



COLORS



Canyon Creek Blend



Charcoal



Cream



Desert Sand



Earth Blend



Flagstone Blend



Granite Blend



MALIBU®



Rugged and textured, the Malibu system is a smaller three-piece system that's reminiscent of Mosaic tiles with various joint lines that create interesting patterns and visual interest.



PRODUCT SPECS

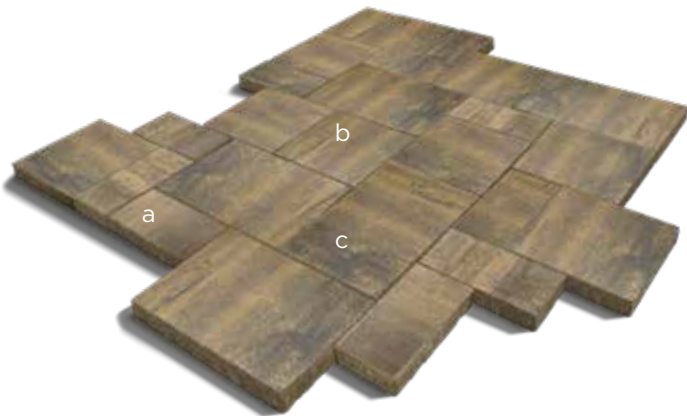

- a) **Malibu Small Rectangle** - $4\frac{3}{4}'' \times 9\frac{3}{8}'' \times 2\frac{3}{8}''$
- b) **Malibu Square** - $9\frac{3}{8}'' \times 9\frac{3}{8}'' \times 2\frac{3}{8}''$
- c) **Malibu Large Rectangle** - $9\frac{3}{8}'' \times 14\frac{1}{8}'' \times 2\frac{3}{8}''$

*All Malibu pavers sold by the layer or cube, not by piece.

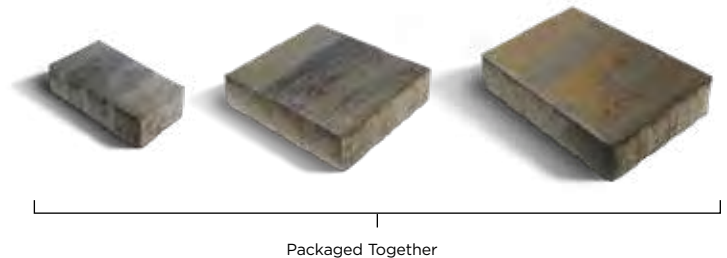

Packaged Together

COLORS



Canyon Creek Blend



Earth Blend



Flagstone Blend



Granite Blend

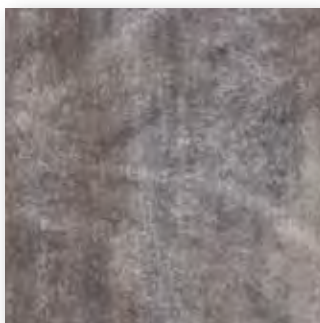

Storm Blend



OZARK®



Reminiscent of a mountainous region, our Ozark pavers feature earth tone colors blends and a slight slate top texture to add depth of color. This over-sized three-piece system gives visual interest to the space with a combination of square units alongside small and large rectangles.

PRODUCT SPECS



- a) **Ozark Small Rectangle** - $7 \frac{1}{8}'' \times 14 \frac{1}{8}'' \times 2 \frac{3}{8}''$
- b) **Ozark Square** - $14 \frac{1}{8}'' \times 14 \frac{1}{8}'' \times 2 \frac{3}{8}''$
- c) **Ozark Large Rectangle** - $14 \frac{1}{8}'' \times 21 \frac{1}{4}'' \times 2 \frac{3}{8}''$

*All Ozark pavers sold by the layer or cube, not by piece.

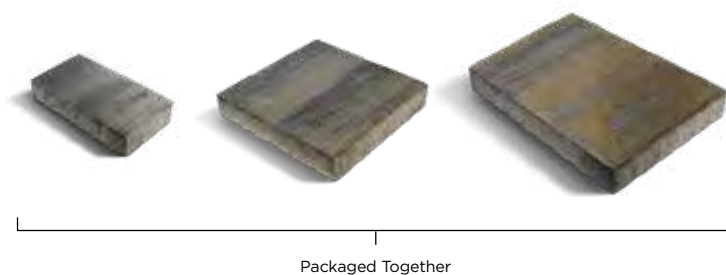

COLORS



Canyon Creek Blend



Earth Blend



Flagstone Blend



Granite Blend

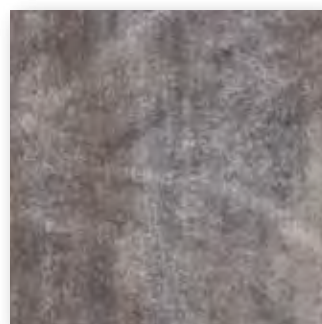

Storm Blend

Due to variations in printing, color selections should always be chosen from actual product samples. Americana Collection pavers require a buffer between the plate compactor and the paver surface to prevent scuffing.



MANHATTAN[®]



Smooth and modern, our Manhattan pavers consist of a three-piece system that mimics the industrial skyline of Manhattan. The same sizes as our Ozark system, the Manhattan is the smooth equivalent. Either installation pattern accounts for various joints that give way to a smooth, clean appearance.

PRODUCT SPECS

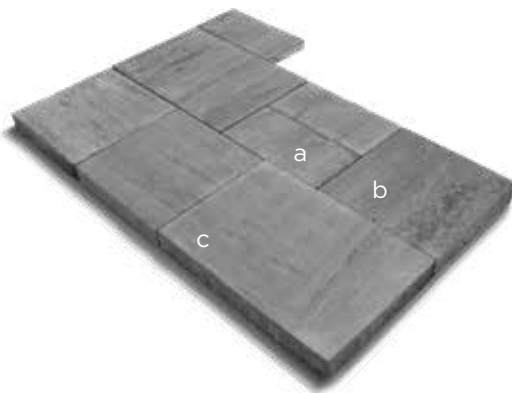

- a) **Manhattan Small Rectangle** - $7 \frac{1}{8}'' \times 14 \frac{1}{8}'' \times 2 \frac{3}{8}''$
- b) **Manhattan Square** - $14 \frac{1}{8}'' \times 14 \frac{1}{8}'' \times 2 \frac{3}{8}''$
- c) **Manhattan Large Rectangle** - $14 \frac{1}{8}'' \times 21 \frac{1}{4}'' \times 2 \frac{3}{8}''$

*All Manhattan pavers sold by the layer or cube, not by piece.

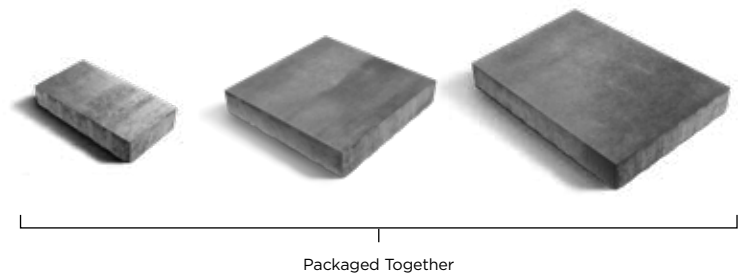

COLORS



Canyon Creek Blend



Earth Blend



Flagstone Blend



Granite Blend



Storm Blend

Due to variations in printing, color selections should always be chosen from actual product samples. Americana Collection pavers require a buffer between the plate compactor and the paver surface to prevent scuffing.



NEWPORT



Smooth and linear, the Newport is a larger scaled system that creates longer, cleaner lines, less joints and a modern appearance.



PRODUCT SPECS

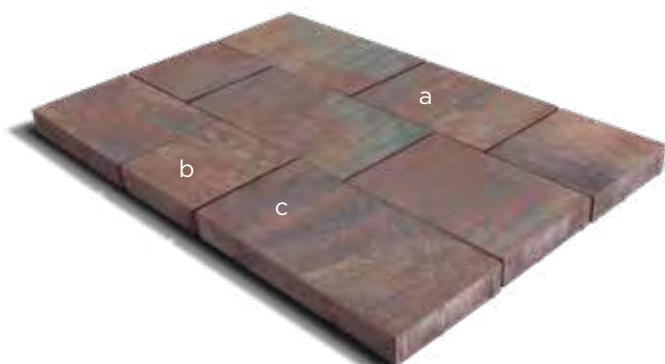

- a) **Newport Small Rectangle** - $11 \frac{3}{4}'' \times 17 \frac{3}{4}'' \times 2 \frac{3}{8}''$
- b) **Newport Square** - $11 \frac{3}{4}'' \times 11 \frac{3}{4}'' \times 2 \frac{3}{8}''$
- c) **Newport Large Rectangle** - $11 \frac{3}{4}'' \times 23 \frac{5}{8}'' \times 2 \frac{3}{8}''$

*All Newport pavers sold by the layer or cube, not by piece.



Packaged Together

COLORS



Canyon Creek Blend



Earth Blend

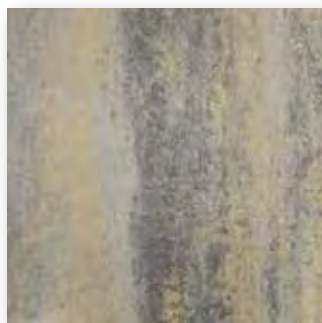

Flagstone Blend



Granite Blend



Storm Blend



JAMESTOWN®



Our Jamestown paver is an ideal paver for bordering and inlays. Perfect for lining sidewalks, outlying entertaining spaces, or creating decorative inlays. Available in both textured and smooth.



PRODUCT SPECS

a) **Jamestown** - $2 \frac{5}{8}'' \times 7 \frac{7}{8}'' \times 2 \frac{3}{8}''$

*All Jamestown pavers sold by the layer or cube, not by the piece.



Textured



Smooth

COLORS



Charcoal Textured



Charcoal Smooth



BULLNOSE

Bullnose pavers give added dimension to any wall, step or patio application when an overhang is desired. The bullnose edge provides a smooth rounded edge that creates a slight shadow line that is the finishing detail in many applications.



PRODUCT SPECS



a



b



c



d

- a) **Single Bullnose** - 6" x 12" x 2 ³/₈"
- b) **Vintage Single Bullnose** - 6" x 12" x 2 ³/₈"
- c) **Double Bullnose** - 6" x 12" x 2 ³/₄"
- d) **Vintage Double Bullnose** - 6" x 12" x 2 ³/₄"

COLORS



Canyon Creek Blend



Charcoal



Dark Chocolate



Desert Sand



Earth Blend



Flagstone Blend



ROSETTA® GRAND FLAGSTONE*

Large natural flagstones have been a highly sought-after material for patios and walkways for generations. Rosetta® Grand Flagstone maintains the attractive texture and scale of large natural flagstone, but compared to natural flagstone, can be laid in an easy-to-install pattern. Additionally, the unit thicknesses are consistent, making for a comfortable, quality finished installation.



PRODUCT SPECS

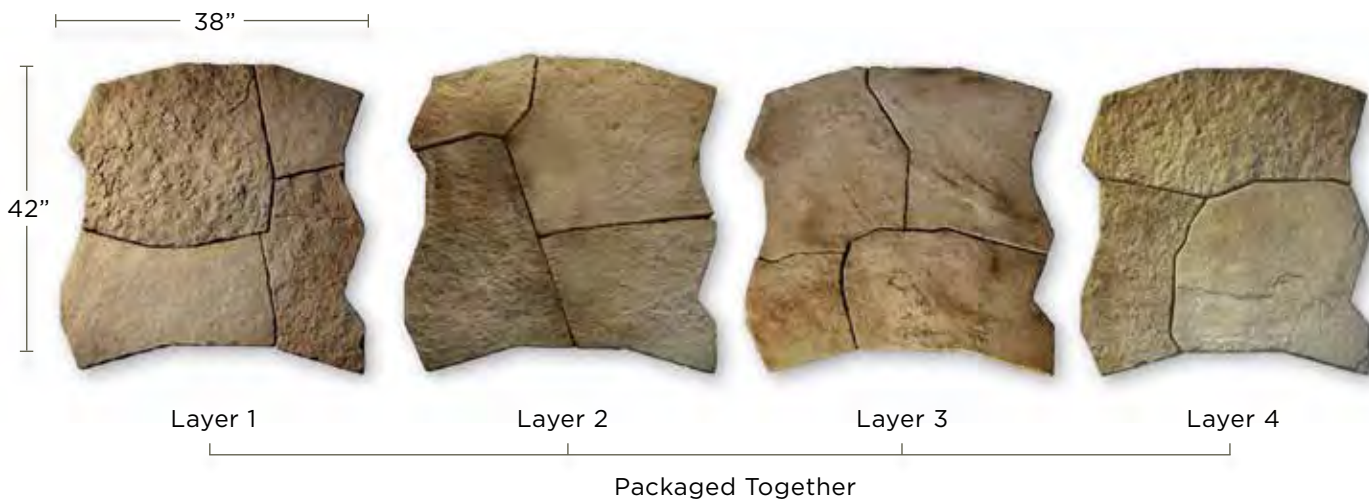

Rosetta® Grand Flagstone*

Dimensions - All Grand Flagstone are 1³/₄" thick

All Grand Flagstone sold by layer or cube, not by piece.

COLORS



Cuyahoga Blend



Scioto Blend

Due to variations in printing, color selections should always be chosen from actual product samples. Textured pavers require a buffer between the plate compactor and paver surface to prevent scuffing.

* Not available in MI.

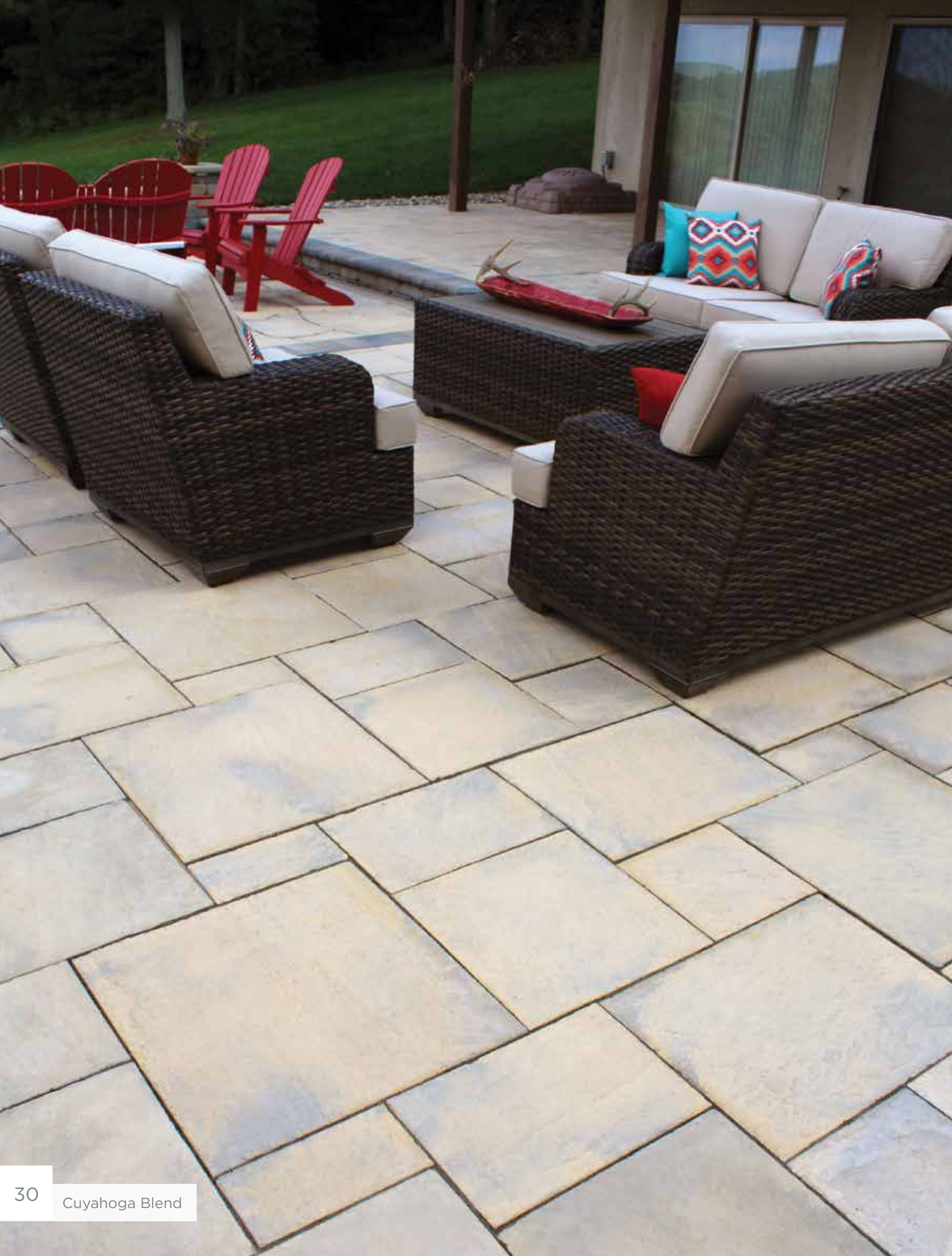

ROSETTA® DIMENSIONAL FLAGSTONE*

Rosetta® Dimensional Flagstone mimics an authentic, tile texture using six unique shapes and various stone textures. It's the perfect choice for walkways and elegant patios that require consistent dimensions and a more formal, sophisticated look.

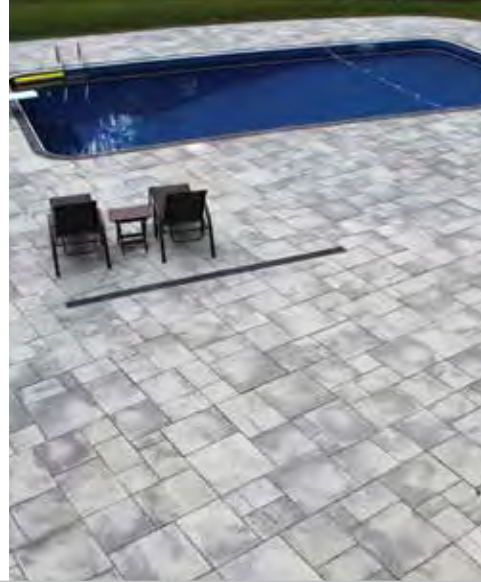

PRODUCT SPECS

- a) **Rosetta® Dimensional Flagstone*** - 6" x 12" x 2"
- b) **Rosetta® Dimensional Flagstone*** - 12" x 12" x 2"
- c) **Rosetta® Dimensional Flagstone*** - 12" x 18" x 2"
- d) **Rosetta® Dimensional Flagstone*** - 18" x 18" x 2"
- e) **Rosetta® Dimensional Flagstone*** - 18" x 24" x 2"
- f) **Rosetta® Dimensional Flagstone*** - 24" x 24" x 2"

All Dimensional Flagstone sold by layer or cube, not by piece

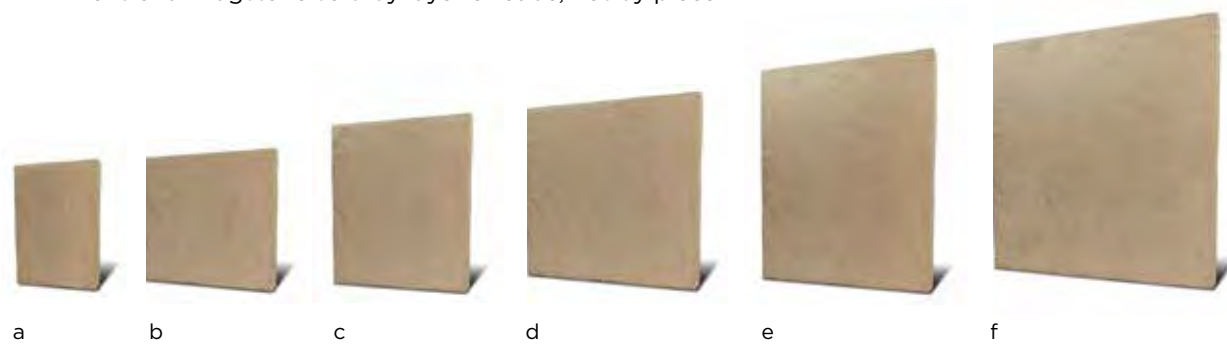

a

b

c

d

e

f

_____ Packaged Together _____

COLORS



Cuyahoga Blend



Scioto Blend

Due to variations in printing, color selections should always be chosen from actual product samples. Textured pavers require a buffer between the plate compactor and paver surface to prevent scuffing.
* Not available in MI.



NATURAL STONE

Add a sense of class with authentic stone products. Best suited for the most exquisite designs where a random and square cut appearance is desired. Add a clean limestone border that is generally smooth in appearance with occasional raven patches to help complete the design.



PRODUCT SPECS

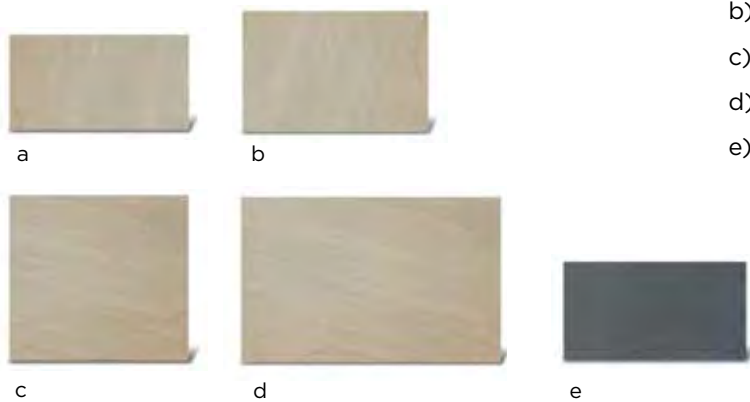

- a) **Natural Stone** - 11.81" x 23.62" x 1"
- b) **Natural Stone** - 17.72" x 23.62" x 1"
- c) **Natural Stone** - 23.62" x 23.62" x 1"
- d) **Natural Stone** - 23.62" x 35.43" x 1"
- e) **Natural Stone Limestone** - 11.81" x 23.62" x 1"

NATURAL STONE COLORS



Bronte Dove Grey Flint Fossil Slate Grey

LIMESTONE COLORS



Kota Black Silver Grey

Due to variations in printing, color selections should always be chosen from actual product samples. Do not use a plate compactor on Natural Stone.



NATURAL STONE ACCESSORIES

Complete your natural stone paver project with accessories that add that final touch. Pool and wall copings, steps, curbs, pier caps and jumbo slabs are all available to complete your natural stone project.

Natural stone accessories are special order products.

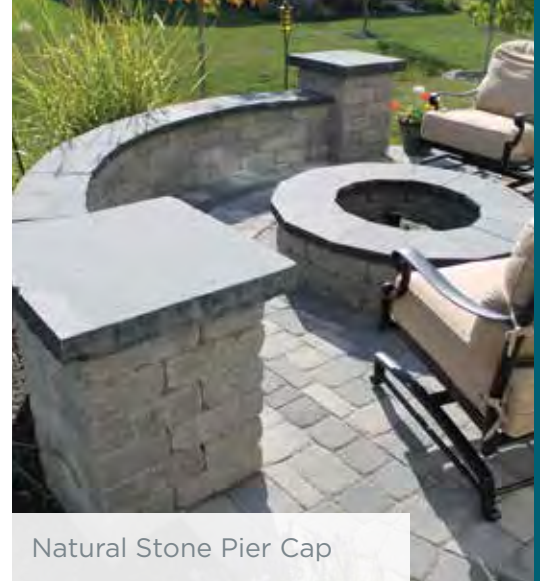

Natural Stone Pier Cap



Natural Stone Pool Coping



Natural Stone Slab



Natural Stone Steps



Natural Stone Wall Stone



TRAVERTINE

Our select-cut travertine offers an upscale appearance that instantly welcomes and defines your space. These multi-shape tiles give you a random pattern that adds visual interest. Border with a contrasting travertine or tumbled paver to add additional dimension to the space. Select-cut travertine is perfect for climates that experience freeze-thaw cycles.

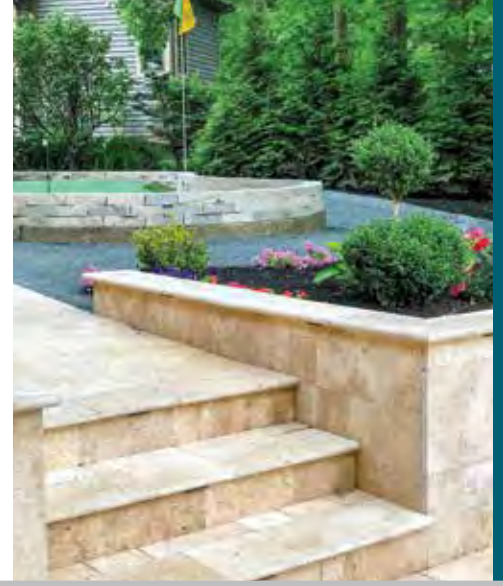

PRODUCT SPECS



- a) **Travertine Small Square** - 8" x 8" x 1¹/₄"
- b) **Travertine Small Rectangle** - 8" x 16" x 1¹/₄"
- c) **Travertine Large Square** - 16" x 16" x 1¹/₄"
- d) **Travertine Large Rectangle** - 16" x 24" x 1¹/₄"
- e) **Travertine Bullnose** - 12" x 24" x 1¹/₄"

COLORS



Blue Marble



Classic Ivory

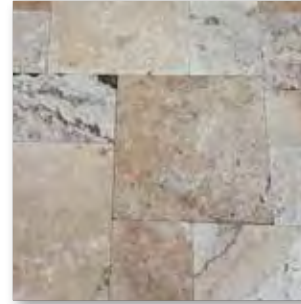

Greige

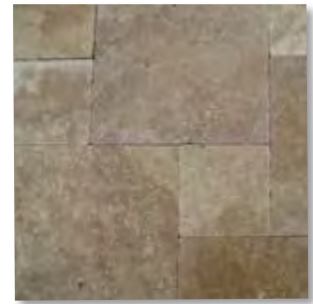

Noche



Tuscan



Walnut

Due to variations in printing, color selections should always be chosen from actual product samples. Do not use a plate compactor on Travertine.



PORCELAIN

Our Porcelain pavers are a collection of colored body porcelain tile surfaces of 20 mm thickness that are ideal outdoor solutions for commercial and residential applications.



PRODUCT SPECS



a) **Porcelain** - 24" x 24"

Select non-stock items available in 18"x36" and 12"x 48".

a

COLORS

BLUESTONE LOOK



Full Color



Blue Select



V4

CONCRETE LOOK



Warm Sand

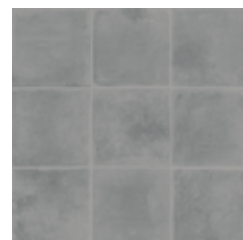

Simply Grey



V1

LIMESTONE LOOK



Limestone



V2

QUARTZ LOOK



Barge Gold

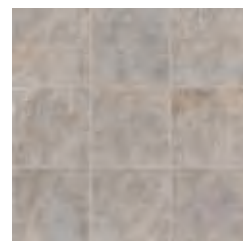

Silver Quartz



V3

SLATE LOOK



Multicolor Gold

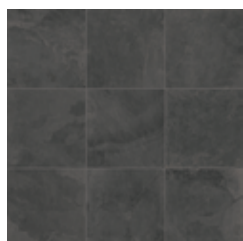

Vintage Slab



V2

WOOD LOOK



Natural Design Walnut

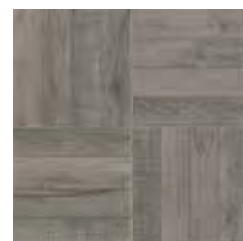

Natural Design Pepper



V3

Due to variations in printing, color selections should always be chosen from actual product samples. Do not use a plate compactor on porcelain pavers.



ROSETTA[®] SUPERIOR STEPPERS

Create a meandering pathway or connect two outdoor spaces together using our Rosetta Superior Steppers. Made from the same high-quality materials as our Rosetta line of products, our Superior Steppers compliment all paver and wall products and provide a nice alternative to traditional walk blocks or patio stones.

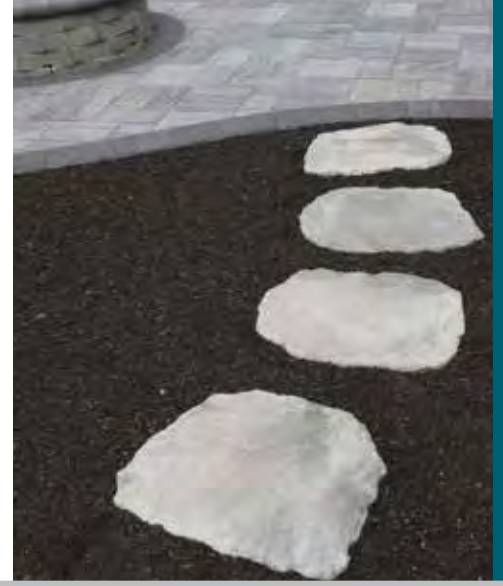

PRODUCT SPECS



a) **Superior Stepper** - 21" x 27" x 2"
Eight different shapes on a cube.



All Superior Steppers are sold by the piece.

COLORS



Cuyahoga Blend



Scioto Blend

Due to variations in printing, color selections should always be chosen from actual product samples. Do not use a plate compactor on Superior Steppers.



INSPIRING SPACES

ROSETTA® BELVEDERE

ROSETTA® DIMENSIONAL

ROSETTA® KODAH

ROSETTA® DIMENSIONAL COPING

ROSETTA® OUTCROPPING

OLENTANGY BLUFF TREAD™

ROSETTA® STEPS

EDINGTON WALL STONE®

NON-WEATHERED VERSA-LOK®

NON-WEATHERED VERSA-LOK® MOSAIC®

WEATHERED VERSA-LOK® MOSAIC®



ROSETTA® BELVEDERE*

Enhance your landscape with the look of natural stone without the waste or expense. Belvedere incorporates the classic look of stone with a natural texture on both its front and back, making it a perfect choice for free-standing walls or columns.



PRODUCT SPECS



Rosetta® Belvedere® Wall, Corner and Coping -

Wall blocks come in different sizes to create a double sided wall

Rosetta® Belvedere also available in corners and copings.

COLORS



Cuyahoga Blend



Scioto Blend

BELVEDERE FIREPIT

The Belvedere Fire Pit creates a rustic sophistication all its own. The Belvedere Fire Pit has an outside diameter of five feet and a height of fourteen inches. The proportions of the fire pit creates a perfect focal point for any occasion—from intimate gatherings to larger events. The Belvedere Fire Pit blends seamlessly with the entire collection of attractive Rosetta® paver and wall lines.



Rosetta® Belvedere Firepit Pallet -

Each pallet contains all of the 3" and 6" tall pieces and the coping needed to create the fire pit shown above. Outside dimension 58". Fire pit includes black steel ring.



ROSETTA® DIMENSIONAL*

The hand-dressed, chiseled texture of Dimensional Wall will truly give your landscape an understated elegance. Garden walls, freestanding walls, columns, and edging are just a few of the many possibilities. Discerning homeowners and design experts are attracted to the formal, yet natural appearance of Dimensional Wall.



PRODUCT SPECS



a

a) Rosetta® Dimensional Wall Straight Block* - 12" x 8" x 4"



b

b) Rosetta® Dimensional Wall Wedge Block* - 12" x 8" x 4"

COLORS



Cuyahoga Blend



Scioto Blend



ROSETTA[®] KODAH^{*}

The Rosetta[®] Kodah Wall is the perfect mix of rustic and modern. The wall boasts large scale wall units with linear proportions. Its freshly quarried stone texture compliments a variety of applications.



PRODUCT SPECS

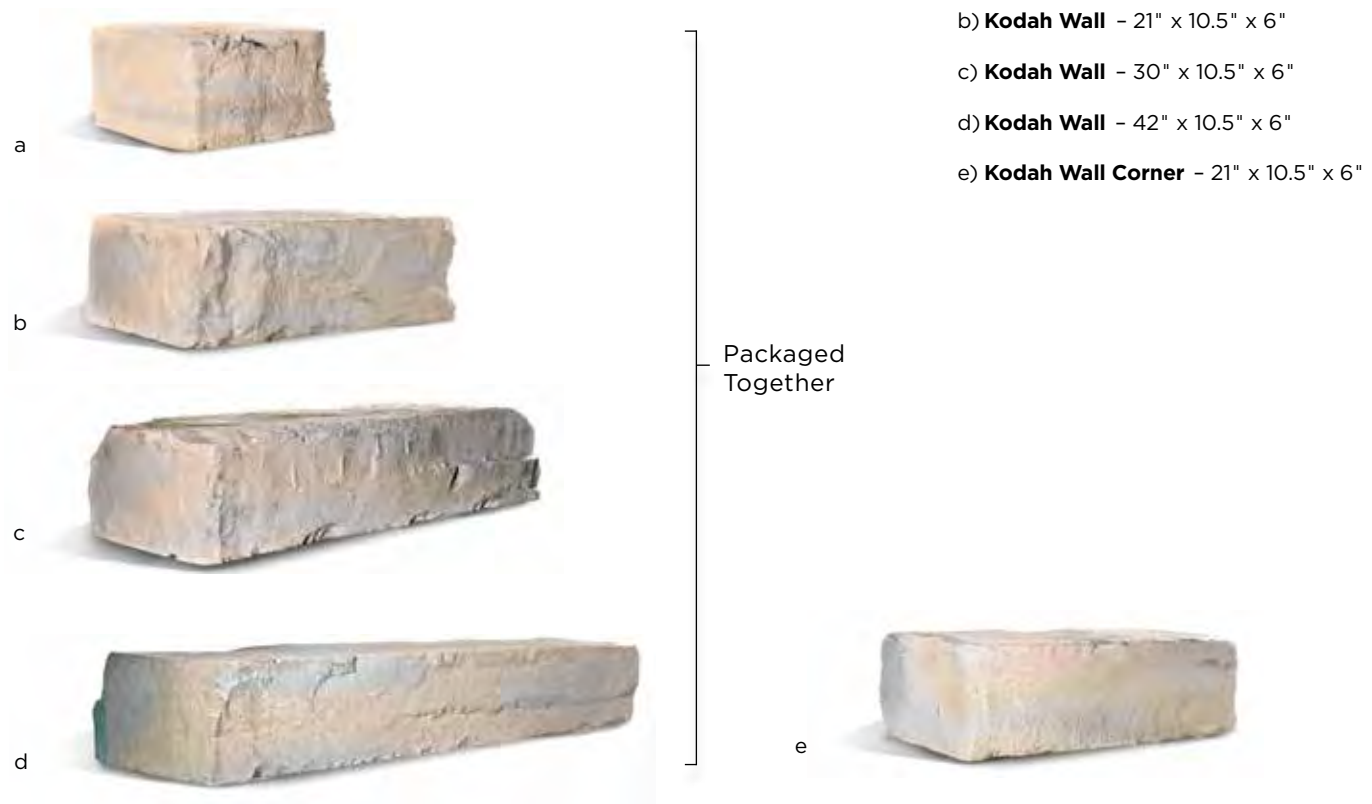

COLORS



Cuyahoga Blend



Scioto Blend



ROSETTA[®] DIMENSIONAL COPING*

Finish off your wall system with a chiseled, natural stone textured coping. Rosetta[®] Dimensional Coping complements all wall systems and adds the finishing touch to your natural-looking wall.



PRODUCT SPECS



a

a) **Standard Coping*** - 18" x 12.5" x 2.5"

b) **Finished End Coping*** - 19" x 12.5" x 2.5"

c) **Long Coping*** - 24" x 12.5" x 2.5"

Packaged Together



b



c

COLORS



Cuyahoga Blend



Scioto Blend

Due to variations in printing, color selections should always be chosen from actual product samples.

* Not available in MI.



ROSETTA® OUTCROPPING*

Unlock the beauty and nuance of nature itself in your outdoor setting with the Rosetta® Outcropping Wall Collection. Incorporate the classic look of weather-hewn stone and steps in a variety of natural sculpted faces. Each piece is made of architectural-grade, precast concrete of the finest quality, the integrity of which will not be compromised by weather's unpredictable elements.



PRODUCT SPECS



a

a) **Rosetta® Outcropping Wall Stone*** - 12" H x 42" L
(unit shown is one of a 12 piece modular system)

b) **Rosetta® Outcropping Wall Stone*** - 12" H x 54" L
(unit shown is one of a 12 piece modular system)

Rosetta® Outcropping Wall Stone Corner 6" - 6" H x 39" L x 27" D

Rosetta® Outcropping Wall Stone Corner 12" - 12" H x 48" L x 30" D



b

COLORS



Cuyahoga Blend



Scioto Blend

Due to variations in printing, color selections should always be chosen from actual product samples.

* Not available in MI.



OLENTANGY BLUFF TREAD™

Combine the character of natural stone with the proven durability of concrete. Our Olentangy Bluff Tread features a smooth-top and random face texture to ensure a natural and unique appearance.



PRODUCT SPECS

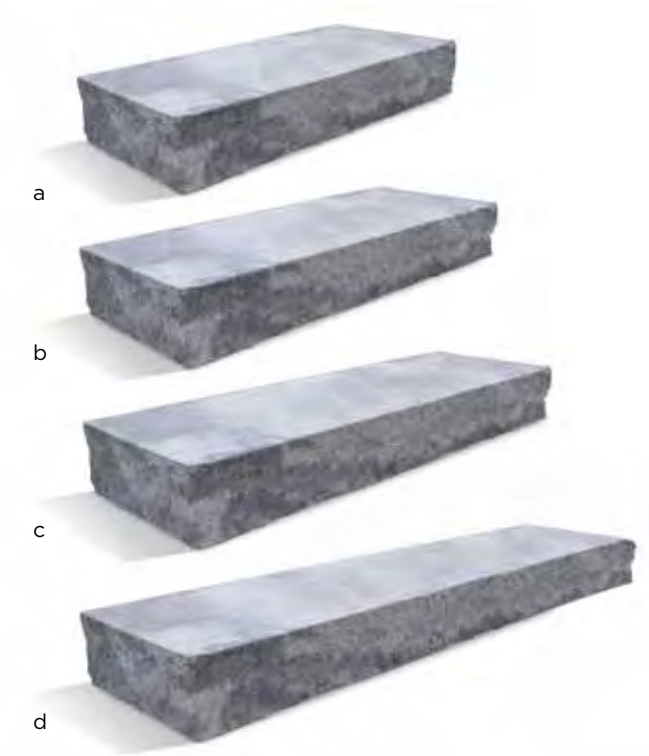

- a) **Olentangy Bluff Tread™** - 36" L x 16" D x 6" H
- b) **Olentangy Bluff Tread™** - 48" L x 16" D x 6" H
- c) **Olentangy Bluff Tread™** - 60" L x 16" D x 6" H
- d) **Olentangy Bluff Tread™** - 72" L x 16" D x 6" H

COLORS



Cuyahoga Blend



Scioto Blend



ROSETTA® STEPS

The Rosetta® Step Collection gives you the rugged attractiveness of natural stone but combines it with the safety and comfort of a uniform rise. Rosetta's® Irregular Step is perfect for free-flowing, natural staircases, while Rosetta's® Dimensional Step is ideal for more formal, sophisticated settings.



PRODUCT SPECS



a) Rosetta® Irregular Steps*

All irregular steps have 7" rise

42" L x 17" D x 7" H

42" L x 26" D x 7" H

54" L x 22" D x 7" H

48" L x 24" D x 7" H

48" L x 28" D x 7" H

60" L x 24" D x 7" H

b) Rosetta® Dimensional Steps*

All dimensional steps have 7" rise

36" L x 18" D x 7" H

48" L x 18" D x 7" H

72" L x 30" D x 7" H

Packaged Together

COLORS



Cuyahoga Blend



Scioto Blend

Due to variations in printing, color selections should always be chosen from actual product samples.

* Not available in MI.



EDINGTON WALL STONE®

Perfect for the homeowner doing a small decorative wall, or a party-friendly seat wall, our Edington Wall Stone® is an attractive and practical improvement upon nature's finest. Edington Wall Stone® requires no mortar and can be used in curved or straight walls, planters, columns and as steps. Available in both tumbled and non-tumbled.

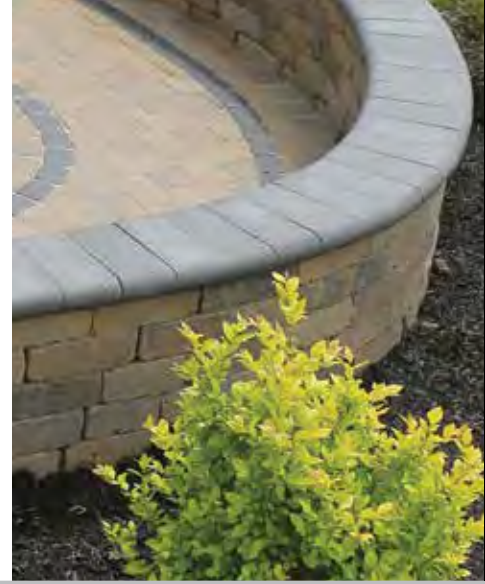

PRODUCT SPECS

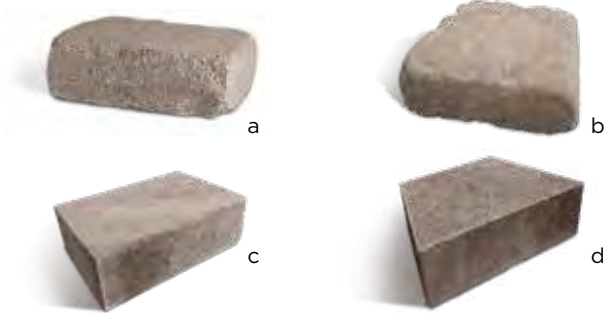

- a) **Edington Wall Stone®** - 12" x 8" x 4"
- b) **Edington Wall Stone® Wedge** - 12" x 8" x 4"
- c) **Non-Tumbled Edington Wall Stone®** - 12" x 8" x 4"
- d) **Non-Tumbled Edington Wall Stone® Wedge** - 12" x 8" x 4"

COLORS (Shown in tumbled)



Canyon Creek Blend

Desert Sand

Earth Blend



Flagstone Blend

Limestone

Quarrystone Blend

BANDING AND ACCENTS



Charcoal

EDINGTON® FIRE PIT KIT

Build a fire pit in no time with our Edington® Fire Pit Kit. This kit has an outside diameter of 48" and a height of 12". Kit includes a steel metal ring. Optional precast caps are available for a different look at an additional cost. Great for small fires, roasting marshmallows and hot dogs.



Outside dimension 48"



NON-WEATHERED VERSA-LOK®

When looking for a retaining wall unit that is engineered to retain heavy loads, Versa-Lok's® solid unit durability is the perfect fit. Versa-Lok® is the only solid, true top to bottom pinned system on the market. It's durable, design friendly, and virtually maintenance free attributes handle the harshest conditions.



PRODUCT SPECS

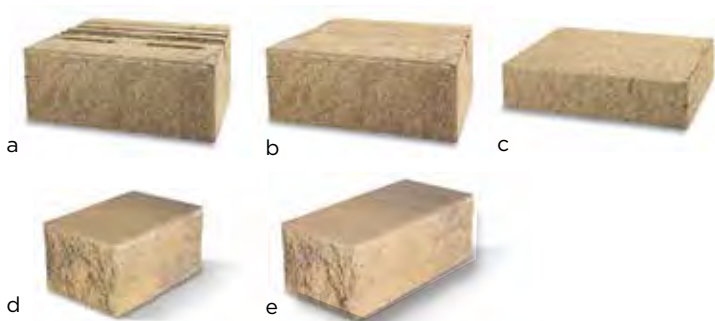

- a) **Versa-Lok®** - 16" (face) x 14" (rear) x 12" D x 6" H
- b) **Smooth Top Versa-Lok®** - 16" (face) x 14" (rear) x 12" D x 6" H
- c) **Rectangular Cap** - 16" (face) x 11⁵/₈" D x 3⁵/₈" H
- d) **Solid Corner** - 7⁷/₈" (face) x 12" D x 6" H
- e) **Full Return Corner** - 16" (face) x 7⁷/₈" D x 6" H

COLORS



Antique Blend



Canyon Creek Blend



Charcoal



Chestnut Blend



Desert Sand Blend



Earth Blend



Flagstone Blend



Granite Blend



Gray Blend



NON-WEATHERED VERSA-LOK[®] MOSAIC[®]

Four different segmental retaining wall options: Standard, Accent, Cobble and Mosaic[®]. Our Non-Weathered Versa-Lok[®] Mosaic[®] Retaining walls can create everything from small, four-foot backyard walls to 40-foot serpentine walls. Use the three sizes together to form the Mosaic[®] System or separate for three unique walls.



PRODUCT SPECS

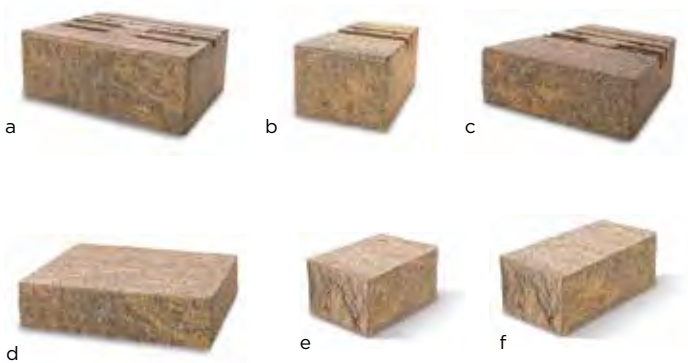

- a) **Versa-Lok[®] Non-Weathered Standard** - 16" (face) x 14" (rear) x 12" D x 6" H
- b) **Versa-Lok[®] Non-Weathered Cobble** - 8" (face) x 12" D x 6" H
- c) **Versa-Lok[®] Non-Weathered Accent** - 12" (face) x 12" D x 4" H
- d) **Rectangular Cap** - 16" (face) x 11⁵/₈" D x 3⁵/₈" H
- e) **Solid Corner** - 7⁷/₈" (face) x 12" D x 6" H
- f) **Full Return Corner** - 16" (face) x 7⁷/₈" D x 6" H

COLORS



Canyon Creek Blend



Earth Blend



Flagstone Blend

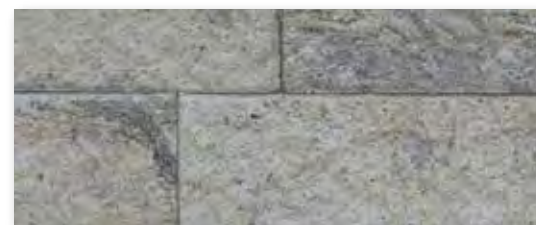

Granite Blend



WEATHERED VERSA-LOK® MOSAIC®

Recreate the intimate setting of a quaint European countryside right in your own backyard using Weathered Versa-Lok® Mosaic® Retaining Walls. Marvel at the age-old craftsmanship each and every random-patterned Mosaic® wall exudes. Three unique Versa-Lok® units- Standard, Cobble, and Accent-combine to form a Mosaic® wall that's redolent of another age.



PRODUCT SPECS



a



b



c



d



e



f

a) **Versa-Lok® Weathered Standard** - 16" (face) x 14" (rear) x 12" D x 6" H

b) **Weathered Cobble** - 8" (face) x 12" D x 6" H

c) **Weathered Accent** - 12" (face) x 12" D x 4" H

d) **Rectangular Cap** - 16" (face) x 11⁵/₈" D x 3⁵/₈" H

e) **Solid Corner Unit** - 7⁷/₈" (face) x 12" D x 6" H

f) **Full Return Corner** - 16" (face) x 7⁷/₈" D x 6" H

COLORS



Canyon Creek Blend



Earth Blend



Flagstone Blend



Granite Blend

EDINGTON®

Build a fire pit in no time with our Edington Fire Pit Kit. Place base units on 4-6 inches of prepared compacted base and adhere units as you construct. Great for small fires, roasting marshmallows and hot dogs. Available in both tumbled and non-tumbled Edington's.



Optional
Precast Caps



OVERALL DIMENSIONS
12" H x 48" Diameter

KIT COMPONENTS

- 39 Edington Wall Stone Wedge Units
- 3 - 10 oz. Tubes of Adhesive
- Steel Ring
- Optional Grill Grate
- Optional Precast Rockface Caps

EDINGTON COLORS



Canyon Creek Blend

Charcoal

Desert Sand

Earth Blend



Flagstone Blend

Limestone

Quarrystone Blend

PRECAST CAP COLORS



Cuyahoga Blend

Scioto Blend

BELVEDERE FIRE PIT KIT*

The Belvedere Fire Pit creates a rustic sophistication all its own. The Belvedere Fire Pit has a diameter of approximately five feet and a height of fourteen inches, the proportions of the fire pit creates a perfect focal point for any occasion—from intimate gathers to larger events. The Belvedere Fire Pit blends seamlessly with the entire collection of attractive Rosetta® paver and wall lines. Kit includes steel metal ring.

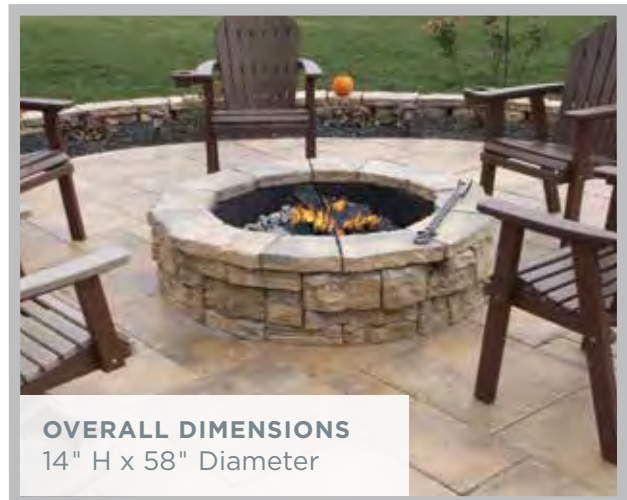

OVERALL DIMENSIONS
14" H x 58" Diameter

BELVEDERE COLORS



Cuyahoga Blend



Scioto Blend

KIT COMPONENTS

- 52 Rosetta® Belvedere Units
- 3 - 10 oz. Tubes of Adhesive
- Steel Ring
- Optional Grill Grate

Due to variations in printing, color selections should always be chosen from actual product samples. * Not available in MI.

ROSETTA® DIMENSIONAL FIRE KIT

The Dimensional Wall Fire Pit Kit features hand-hewn stone texture with consistent dimensions to create a natural looking square fire pit.



OVERALL DIMENSIONS

12" H x 44" W x 44" D

KIT COMPONENTS

- 36 Rosetta® Dimensional Units
- 3 - 10 oz. Tubes of Adhesive
- Steel Liner

COLORS



Cuyahoga Blend



Scioto Blend

ROSETTA® KODAH FIRE KIT

The Dimensional Wall Fire Pit Kit features hand-hewn stone texture with consistent dimensions to create a natural looking square fire pit.



OVERALL DIMENSIONS

12" H x 48" Diameter

KIT COMPONENTS

- 21 Rosetta® Kodah Wall Units
- 3 - 10 oz. Tubes of Adhesive
- Steel Liner
- Optional Grill Grate

COLORS



Cuyahoga Blend



Scioto Blend

EDINGTON® PUB TABLE KIT

Add additional entertaining space with our Pub Table Kit. The large table top allows plenty of room to enjoy drinks or a snack. The bottom foot rest is great for propping up your feet. Available in both tumbled and non-tumbled Edington's.



OVERALL DIMENSIONS

42" H × 48" W × 48" D

KIT COMPONENTS

- 36 Edington Wall Stone pieces - stocked kit colors below
- 1-42" Table Top with 2" hole
- 1-28" Foot Rest with 2" hole - Both pieces 3" thick - The 2" hole fits standard umbrella (not included)
- 2-10 oz. Tubes of Adhesive
- Optional 42" Round Table Top with 2" hole (non stock)

EDINGTON COLORS

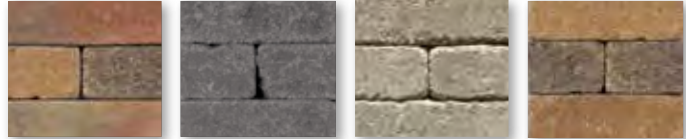

Canyon Creek Blend

Charcoal

Desert Sand

Earth Blend



Flagstone Blend

Limestone Blend

Quarrystone Blend

PRECAST CAP COLORS



Cuyahoga Blend

Scioto Blend

EDINGTON® GRILL KIT

Ideal for advanced installers that would like to create a professional outdoor grilling station. Constructed from our popular Edington Wall Stone units, this kit allows you to drop in the included grill, for a clean and professional grill station. The kit is large enough to both cook at or entertain guests at. Available in both tumbled and non-tumbled Edington's.



OVERALL DIMENSIONS

38" H × 102" W × 32" D

KIT COMPONENTS

- 1 Three-Burner Built-In Grill
- Grill Doors
- 190 Edington Wall Stone Units
- 1 Precast Counter Top
- 1 Case of Adhesive
- 1 Steel Lintel 40"

EDINGTON COLORS



Canyon Creek Blend

Charcoal

Desert Sand

Earth Blend



Flagstone Blend

Limestone Blend

Quarrystone Blend

PRECAST COUNTERTOP COLORS



Cuyahoga Blend

Scioto Blend

SPECIAL ORDER COLORS

VINTAGE FLAT TOP WASHINGTON®



Vintage Antique Blend

Vintage Desert Sand Blend (14's only)

EDINGTON WALL STONE



Autumn

Fieldstone

Sierrastone

PORCELAIN (18" x 36")

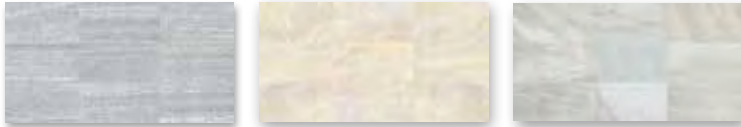

Pietra di Bagnolo

Pietra di Barge

Point Silver



Sight Antracite

Sight Grey

Source Beige

NON-WEATHERED VERSA-LOK®



Brown

NON-WEATHERED VERSA-LOK® MOSAIC



Chestnut Blend

PORCELAIN (12" x 48")

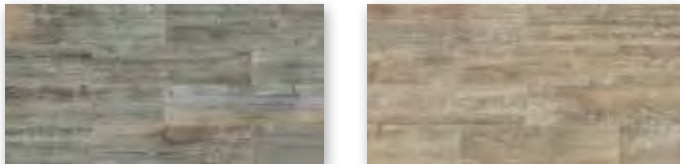

Soul Grey

Soul Walnut

WEATHERED VERSA-LOK® MOSAIC



Chestnut Blend

TRAVERTINE



Gold

Silver

Due to variations in printing, color selections should always be chosen from actual product samples. Textured pavers require a buffer between the plate compactor and paver surface to prevent scuffing.



FIREROCK® FIREPLACES

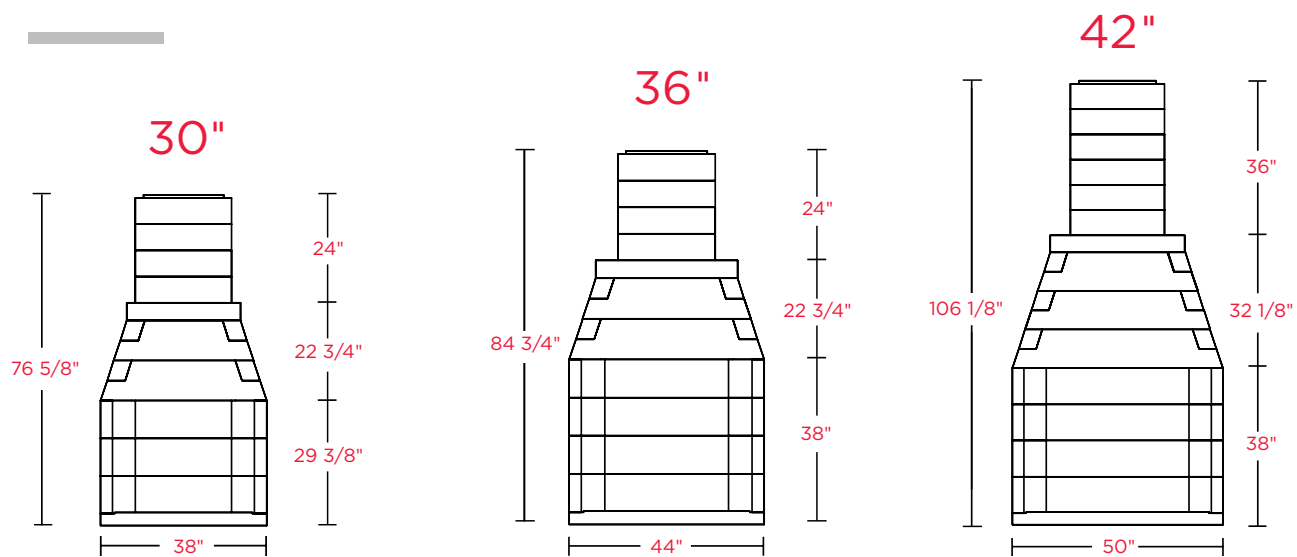

Model	Overall Height	Overall Depth	Overall Width	Overall Diameter	Firebox Opening Height	Smoke Chamber Height	Weight in Pounds
30" Outdoor Fireplace	76.63"	28.5"	38"	n/a	29.38"	23"	1900
36" Outdoor Fireplace	84.75"	28.5"	44"	n/a	38"	23"	2100
42" Outdoor Fireplace	106.13"	28.5"	50"	n/a	38"	32.5"	2600
36" Arched Front Outdoor Fireplace	84.75"	28.5"	44"	n/a	34"	23"	2160
42" Arched Front Outdoor Fireplace	106.13"	28.5"	50"	n/a	34"	32.5"	2670

*Measurement at top of arch. ** Height Extension Kit adds 6 inches to overall height. The kit also adds 320-1512 lbs depending on the width of the FireRock.



OUR **NEW** ALL-IN-ONE SEALER IS THE DIFFERENCE MAKER.

How many reasons do you need?

Our new Dura Denz All-In-One penetrating sealer enhances color and texture, stabilizes joint sand, and protects against mold, moss and algae. Formulated to resist UV rays, Dura Denz Sealers help to retain the pavers original color while also repelling water and stains. It can be applied immediately after installation on a clean, dry installation and is rain safe in 60 minutes.

Dura Denz Sealers are formulated to give maximum coverage for up to 5-6 years. Although formulated in conjunction with the Americana Collection pavers, Dura-Denz Sealers may also be applied to any type of concrete paver, clay paver, flat and stamped concrete, and masonry surfaces such as concrete walls, exposed aggregate and retaining walls.

Make sure you ask your contractor about this very important last step to a professional grade finish. By committing to an easy maintenance plan, you can keep stains from penetrating your hardscape surface and make a world of difference to the look and longevity of your paver project!



Dura Denz penetrating sealers are offered in both water based and solvent based formulas. Each formula offers two finishes—a wet look and a matte look. Either finish adds enhancement and protection for years, with minimal maintenance. Both are environmentally friendly.

SOLVENT BASED
-WET LOOK
-MATTE

WATER BASED
-WET LOOK
-MATTE



COLUMN CAPS

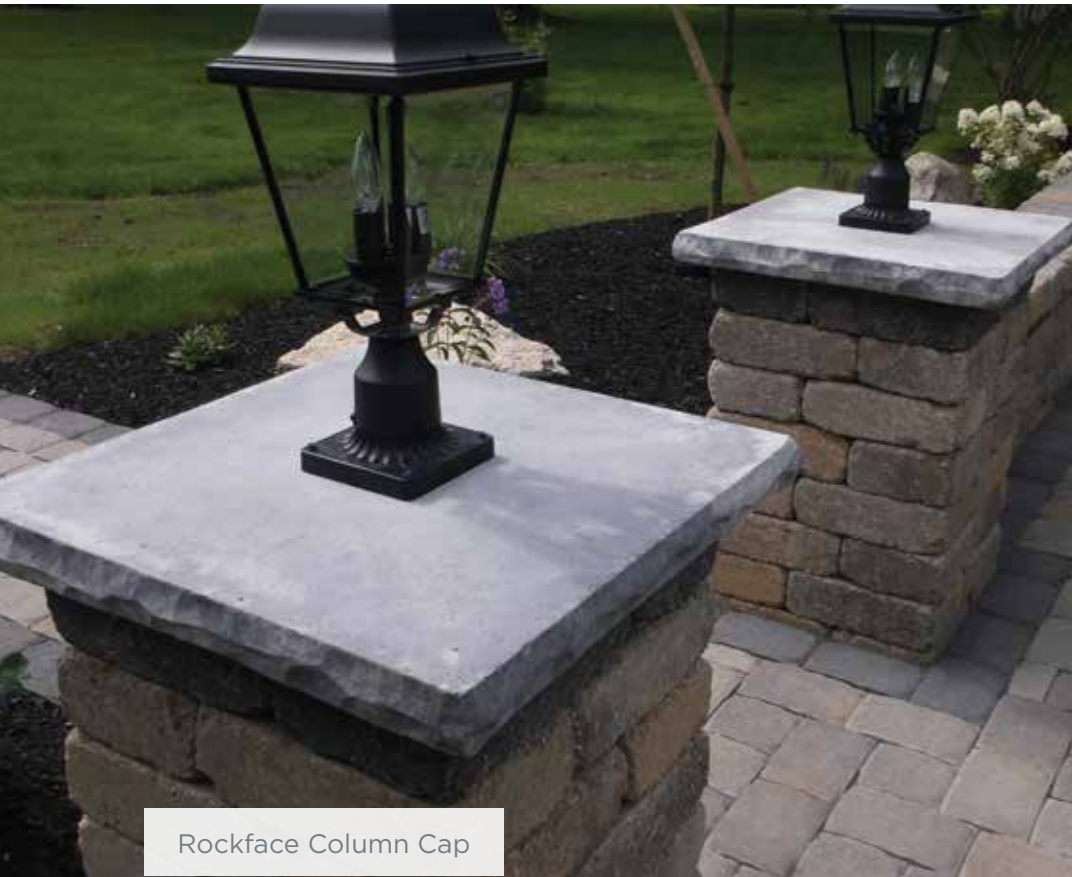

Rockface Column Cap



Rosetta® Belvedere Column Cap

STOCKED ROCKFACE CAP SIZES

- 24" x 24" x 2"
- 24" x 24" x 3"
- 28" x 28" x 2"
- 28" x 28" x 3"



Natural Stone Pier Cap & Coping

PRECAST CAP COLORS



Cuyahoga Blend



Scioto Blend



Bullnose Column Cap

FIREPLACES & FIRE PITS

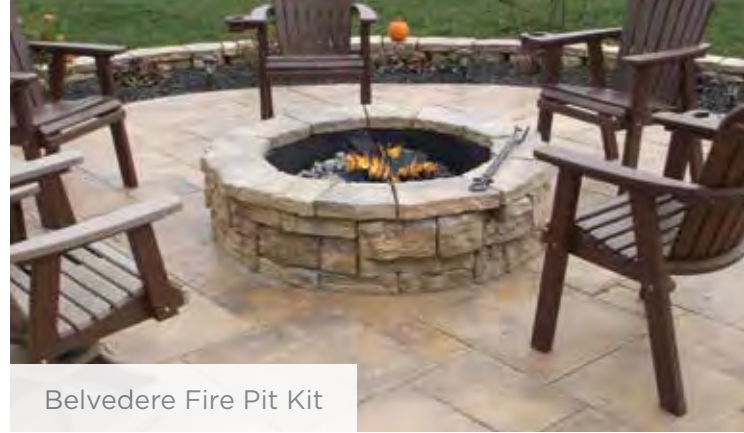

Belvedere Fire Pit Kit



Edington Fireplace

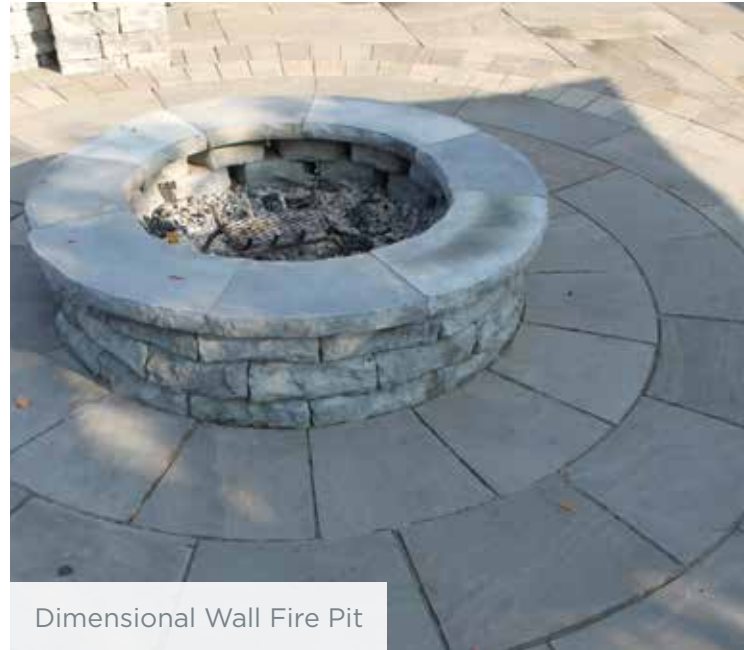

Dimensional Wall Fire Pit



Kodah Fire Pit



Edington Fire Pit



Custom Belvedere Fire Pit



KICHLER® LIGHTING

Let your landscape lighting illuminate every occasion and invite people into your home safely and beautifully highlighting walkways, architectural elements, gathering spaces, water features and more. A landscape lighting professional can show you all of the possibilities to deliver the best, most efficient lighting to bring your home to life.

Kichler® Landscape Lighting offers some of the most technologically advanced products available. They are engineered and tested to perform under extreme environmental conditions and are backed by Kichler's industry-leading 15 year warranty.



ENJOY THE OUTDOORS UNDER A SHADE

PAVILIONS

Pavilions can be an extension of your home, or a freestanding structure providing shade and visual interest to your yard.

PERGOLAS

If you want to immerse yourself in the outdoors, but enjoy some sun protection, pergolas are a perfect fit.

GAZEBOS

Gazebos allow you to enjoy the outdoors while being comfortable and sheltered.



Pavilion with Shingle Roof



Pavilion with Metal Roof



Vinyl Gazebo



Vinyl Pergola



Cedar Pergola

PAVER PATTERNS

LEXINGTON

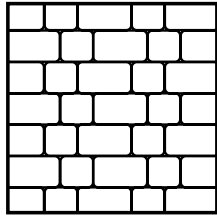

Muster D
40% Lexington 14
60% Lexington 21

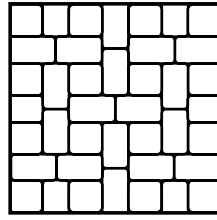

Muster K
28% Lexington 14
72% Lexington 21

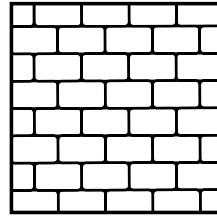

Running Bond
10, 14, or 21

PLYMOUTH

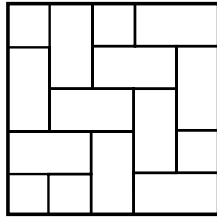

90° Herringbone

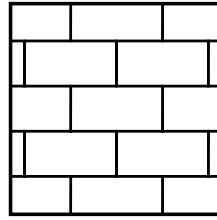

Running Bond

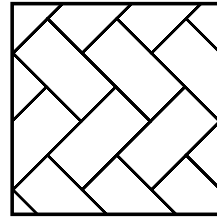

45° Herringbone

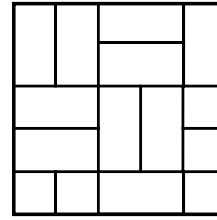

Basketweave

JAMESTOWN

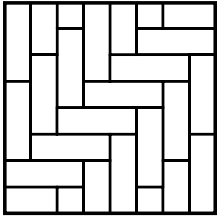

90° Herringbone

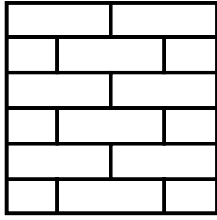

Running Bond

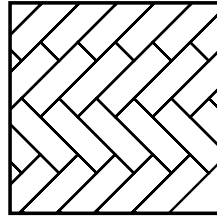

45° Herringbone

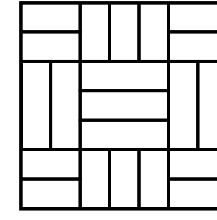

Pattern A

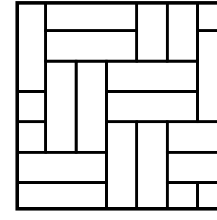

Pattern B

MALIBU

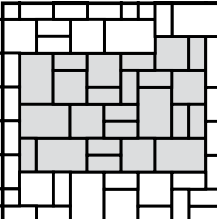

Pattern A

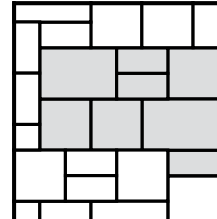

Pattern A

OZARK & MANHATTAN

NEWPORT

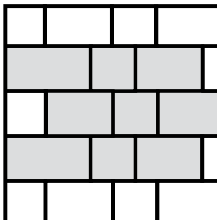

Pattern A

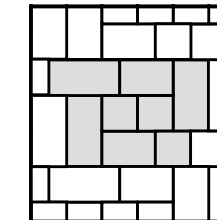

Pattern B

FLAT TOP WASHINGTON® & VINTAGE FLAT TOP WASHINGTON® PAVERS

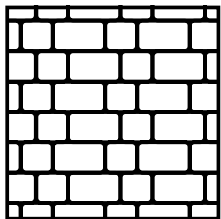

Muster D
40% Wash. 14
60% Wash. 21

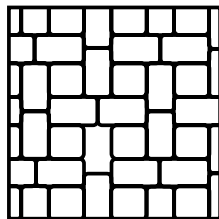

Muster K
28% Wash. 14
72% Wash. 21

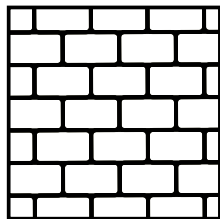

Running Bond
10, 14, or 21

NATURAL STONE PAVERS

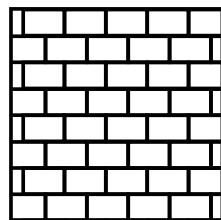

Running Bond
11.81" x 23.62",
17.72" x 23.62", or
23.62" x 35.43"

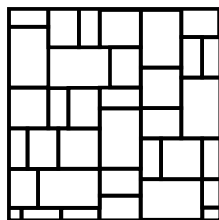

4 Piece Random
25% 11.81" x 23.62"
30% 17.72" x 23.62"
25% 23.62" x 35.43"
20% 23.62" x 23.62"

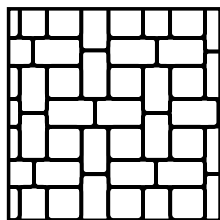

Jumbo Muster K
28% Large Sq.
72% Jumbo Rec.

TRAVERTINE PAVERS

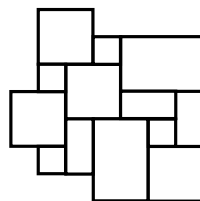

French Pattern

LEXINGTON CIRCLE® PAVER

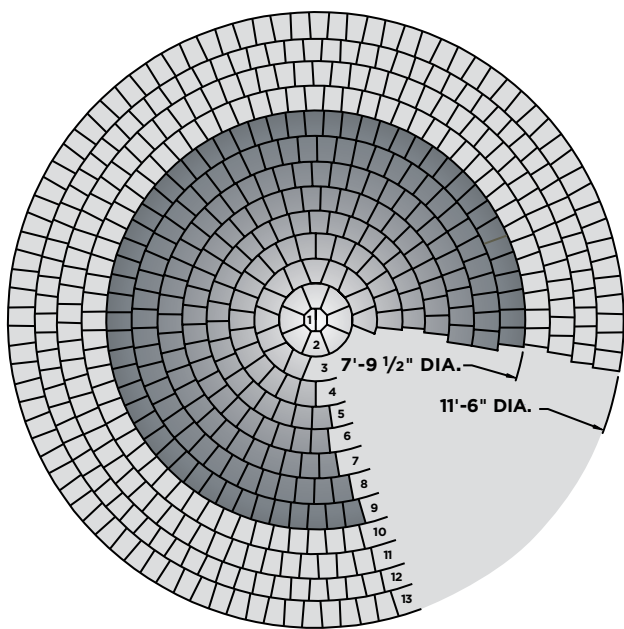

	Row	Circle Dia.	Installation Pattern	Paver Description Series
First Circle Pack	1	5 1/2"	Single	2 Half Circle Pieces
	2	16 1/2"	Single	8 Large Wedges
	3	27 1/2"	Alternate	8 Large Wedges, 8 Lex. 10's
	4	38 1/2"	Single	26 Small Wedges
	5	49 1/2"	Single	33 Small Wedges
	6	60 1/2"	Single	42 Small Wedges
	7	71 1/2"	Alternate	25 Small Wedges, 25 Lex. 10's
	8	82 1/2"	Alternate	29 Small Wedges, 29 Lex. 10's
	9	93 1/2"	Alternate	34 Small Wedges, 34 Lex. 10's
Second Circle Pack	10	104 1/2"	Alternate	38 Small Wedges, 38 Lex. 10's
	11	115 1/2"	Alternate	42 Small Wedges, 42 Lex. 10's
	12	127"	Alternate	46 Small Wedges, 46 Lex. 10's
	13	138"	Alternate	50 Small Wedges, 50 Lex. 10's
Additional Pieces	14 & Up		Single	As needed
Notes	Due to the complex shapes of the pieces in a circle, there will be some extra pieces not used for standard installation.			

Half Circle Pieces = +6 units waste

Large Wedge Pieces = 0 units waste

Small Wedge Pieces = +3 units waste

Lexington 10 Pieces = you will need to add 6 extra 10's to complete layer 12, and 50 extra 10's to complete layer 13.

PACKAGING REFERENCE GUIDE

PAVER PRODUCTS		STOCKED	NOMINAL DIMENSIONS	DIMENSIONS	WEIGHT PER SQ. FT	
Flat Top Washington* 14		X	5 1/2" x 5 1/2" x 2 3/8"	140 mm x 140 mm x 60 mm	29	
Flat Top Washington* 21		X	5 1/2" x 8 1/4" x 2 3/8"	140 mm x 210 mm x 60 mm	29	
Vintage Flat Top Washington* 14		X	5 1/2" x 5 1/2" x 2 3/8"	140 mm x 140 mm x 60 mm	29	
Vintage Flat Top Washington* 21		X	5 1/2" x 8 1/4" x 2 3/8"	140 mm x 210 mm x 60 mm	29	
Lexington* 10		X	4 1/8" x 5 1/2" x 2 3/8"	105 mm x 140 mm x 60 mm	29	
Lexington* 14		X	5 1/2" x 5 1/2" x 2 3/8"	140 mm x 140 mm x 60 mm	29	
Lexington* 21		X	4 1/8" x 8 1/4" x 2 3/8"	140 mm x 210 mm x 60 mm	29	
Lexington Circle* <small>Requires one layer of Lexington 10s to assemble 11.6" diameter circle</small>		X	N/A	N/A	29	
Plymouth*		X	4" x 8" x 2 3/8"	100 mm x 200 mm x 60 mm	29	
Malibu* Small Rectangle		PACKAGED LAYER	X	4 3/4" x 9 3/8" x 2 3/8"	120 mm x 240 mm x 60 mm	29
Malibu* Square			X	9 3/8" x 9 3/8" x 2 3/8"	240 mm x 240 mm x 60 mm	29
Malibu* Large Rectangle			X	9 3/8" x 14 1/8" x 2 3/8"	240 mm x 360 mm x 60 mm	29
Ozark* Small Rectangle		PACKAGED LAYER	X	7 1/8" x 14 1/8" x 2 3/8"	180 mm x 360 mm x 60 mm	29
Ozark* Square			X	14 1/8" x 14 1/8" x 2 3/8"	360 mm x 360 mm x 60 mm	29
Ozark* Large Rectangle			X	14 1/8" x 21 1/4" x 2 3/8"	360 mm x 540 mm x 60 mm	29
Manhattan* Small Rectangle		PACKAGED LAYER	X	7 1/8" x 14 1/8" x 2 3/8"	180 mm x 360 mm x 60 mm	29
Manhattan* Square			X	14 1/8" x 14 1/8" x 2 3/8"	360 mm x 360 mm x 60 mm	29
Manhattan* Large Rectangle			X	14 1/8" x 21 1/4" x 2 3/8"	360 mm x 540 mm x 60 mm	29
Newport* Small Rectangle		PACKAGED LAYER	X	11 3/4" x 17 3/4" x 2 3/8"	300 mm x 300 mm x 60 mm	29
Newport* Square			X	11 3/4" x 11 3/4" x 2 3/8"	300 mm x 450 mm x 60 mm	29
Newport* Large Rectangle			X	11 3/4" x 23 5/8" x 2 3/8"	300 mm x 600 mm x 60 mm	29
Jamestown* Smooth and Textured		X	2 5/8" x 7 7/8" x 2 3/8"	67 mm x 200 mm x 60 mm	29	
Single Bullnose Paver		X	6" x 12" x 2 3/8"	152 mm x 305 mm x 60 mm	30.0	
Vintage Single Bullnose Paver		X	6" x 12" x 2 3/8"	152 mm x 305 mm x 60 mm	30.0	
Double Bullnose Paver		X	6" x 12" x 2 3/4"	152 mm x 305 mm x 70 mm	30.0	
Vintage Double Bullnose Paver		X	6" x 12" x 2 3/4"	152 mm x 305 mm x 70 mm	30.0	
Rosetta* Grand Flagstone [‡]		X	15 unique shapes at 1 3/4" thickness, sold by layers	N/A	20.5	
Rosetta* Dimensional Flagstone [‡]		X	Random sizes available (See page 29 for dimensions)	N/A	24.0	
Rosetta* Superior Steppers [‡]		X	21" x 27" x 2" (Dimensions vary slightly by paver)	533 mm x 686 mm x 51 mm	N/A	

NATURAL STONE	STOCKED	NOMINAL DIMENSIONS	DIMENSIONS	WEIGHT PER SQ. FT
Natural Stone	X	11.81" x 23.62"	300mm x 600mm	13.2
Natural Stone	X	17.72" x 23.62"	450mm x 600mm	13.2
Natural Stone	X	23.62" x 23.62"	600mm x 600mm	13.2
Natural Stone	X	23.62" x 35.43"	600mm x 900mm	13.2
Natural Stone Limestone	X	11.81" x 23.62"	300mm x 600mm	16.5
Travertine	X	Random sizes available (See page 37 for dimensions)	Varies in size	15.0

PORCELAIN PRODUCTS	STOCKED	NOMINAL DIMENSIONS	DIMENSIONS	UNITS PER BOX	UNITS PER CUBE
Porcelain	X	24" x 24"	600 mm x 600 mm x 20 mm	2	60
Porcelain		18" x 36"	457 mm x 914 mm x 20 mm	2	54
Porcelain		12" x 48"	305 mm x 1219 mm x 20 mm	2	32

SPECIAL NOTES: * Asterisk denotes non-stocked shape or color
[‡] Not available in Michigan
[†] Also available in Weathered

Larger circles can be obtained by adding additional Lexington 10's
 Due to the complex size of the pieces in a circle, there will be some extra pieces.
 Weight per Cube does not include pallet weight.

AMERICANA COLLECTION

UNITS PER SQ. FT.	UNITS PER LAYER	LAYERS PER CUBE	UNITS PER CUBE	WEIGHT PER CUBE	SQ. FT. PER UNIT	SQ. FT. PER LAYER	SQ. FT. PER CUBE	COLOR STOCKED
4.76	56		504	3069	0.21	12.50	105.84	Canyon Creek, Charcoal, Earth, Flagstone, Granite
3.17	42		336	3074	0.32	17.00	106	Canyon Creek, Charcoal, Desert Sand, Earth, Flagstone, Granite
4.76	56		504	3069	0.21	12.50	105.84	Vintage: Canyon Creek, Charcoal, Earth, Flagstone, Granite
3.17	42		336	3074	0.32	17.00	106	Vintage: Canyon Creek, Charcoal, Desert Sand, Earth, Flagstone, Granite
6.34	72	9	648	2965	0.16	11.36	102.24	Canyon Creek, Charcoal, Desert Sand, Earth, Flagstone, Granite
4.76	56	9	504	3069	0.21	11.76	105.84	Canyon Creek, Charcoal, Desert Sand, Earth, Flagstone, Granite
3.17	42	8	336	3074	0.32	13.25	106	Canyon Creek, Charcoal, Desert Sand, Earth, Flagstone, Granite
N/A	76	9	608	3011	N/A	12.98	103.84	Canyon Creek, Desert Sand, Earth, Flagstone, Granite
4.7	54	9	486	2999	0.21	11.48	103.32	Canyon Creek, Charcoal, Cream, Desert Sand, Earth, Flagstone, Granite
3.23	13	8	104	2851	0.31	4.03	98.32	Canyon Creek, Earth, Flagstone, Granite, Storm
1.64	6	8	48	2851	0.61	3.66	98.32	Canyon Creek, Earth, Flagstone, Granite, Storm
1.09	5	8	40	2851	0.92	4.6	98.32	Canyon Creek, Earth, Flagstone, Granite, Storm
1.43	3	10	30	3024	0.70	2.1	104.3	Canyon Creek, Earth, Flagstone, Granite, Storm
0.72	3	10	30	3024	1.39	4.17	104.3	Canyon Creek, Earth, Flagstone, Granite, Storm
0.48	2	10	20	3024	2.08	4.16	104.3	Canyon Creek, Earth, Flagstone, Granite, Storm
1.43	3	10	30	3024	0.7	2.1	104.3	Canyon Creek, Earth, Flagstone, Granite, Storm
0.72	3	10	30	3024	1.39	4.17	104.3	Canyon Creek, Earth, Flagstone, Granite, Storm
0.48	2	10	20	3024	2.08	4.16	104.3	Canyon Creek, Earth, Flagstone, Granite, Storm
0.69	2	9	18	3020	1.45	2.9	104.13	Canyon Creek, Earth, Flagstone, Granite, Storm
1.04	3	9	27	3020	0.96	2.88	104.13	Canyon Creek, Earth, Flagstone, Granite, Storm
0.52	3	9	27	3020	1.93	5.79	104.13	Canyon Creek, Earth, Flagstone, Granite, Storm
7.14	78	5	390	1583	0.14	10.92	54.6	Charcoal
N/A	56	3	168	2318	N/A	N/A	84	Canyon Creek, Charcoal, Dark Chocolate, Desert Sand, Earth, Flagstone
N/A	56	3	168	2318	N/A	N/A	84	Canyon Creek, Charcoal, Dark Chocolate, Desert Sand, Earth, Flagstone
N/A	48	3	144	2160	N/A	N/A	72	Canyon Creek, Charcoal, Dark Chocolate, Desert Sand, Earth, Flagstone
N/A	48	3	144	2160	N/A	N/A	72	Canyon Creek, Charcoal, Dark Chocolate, Desert Sand, Earth, Flagstone
N/A	N/A		32	2160	N/A	N/A	88	Cuyahoga, Scioto
N/A	N/A		48	2350	N/A	12.25	98	Cuyahoga, Scioto
N/A	N/A		24	1950	N/A	N/A	N/A	Cuyahoga, Scioto

AMERICANA COLLECTION

UNITS PER SQ. FT.	UNITS PER BAND	UNITS PER CUBE	WEIGHT PER CUBE	SQ. FT. PER UNIT	SQ. FT. PER BAND	SQ. FT. PER CUBE	COLOR STOCKED
N/A	N/A	80	2000	N/A	N/A	160	Bronte, Dove Grey, Flint, Fossil, Slate Grey
N/A	N/A	80	2800	N/A	N/A	240	Bronte, Dove Grey, Flint, Fossil, Slate Grey
N/A	N/A	40	2000	N/A	N/A	160	Bronte, Dove Grey, Flint, Fossil, Slate Grey
N/A	N/A	40	2800	N/A	N/A	240	Bronte, Dove Grey, Flint, Fossil, Slate Grey
N/A	N/A	74	2100	N/A	N/A	148	Kota Black, Silver Grey
N/A	N/A	N/A	2640	N/A	N/A	176	Blue Marble, Classic Ivory, Griege, Noche, Tuscany, Walnut

BOXES PER CUBE	SQ. FT. PER UNIT	SQ. FT. PER BOX	TOTAL SQ. FT. PER CUBE	WEIGHT PER BOX	WEIGHT PER CUBE	COLOR STOCKED
30	3.875	7.75	233	73.20	2196	Bluestone, Concrete, Limestone, Quartz, Slate, Wood
27	4.36	8.72	235	82.31	2223	Non-Stock
16	3.875	7.75	124	73.16	1171	Non-Stock

Paver Color Blends: Canyon Creek= buff, charcoal, maroon; Desert Sand= buff; Earth=brown, buff, charcoal; Flagstone=buff, charcoal, gray; Granite=charcoal, gray; Storm=brown, light grey, black.

Due to color variations of pavers, it is advisable to remove them from multiple pallets to insure optimal color blending.

RETAINING WALL PACKAGING REFERENCE GUIDE

RETAINING WALL PRODUCTS	STOCKED	NOMINAL DIMENSIONS	DIMENSIONS	WEIGHT PER SQ. FT	
Rosetta* Belvedere Walls¥	X	Random sizes available	Varies in size	91.667	
Rosetta* Belvedere Corners¥	X	Random sizes available	Varies in size	63.33	
Rosetta* Belvedere Coping¥	X	Random sizes available	Varies in size	N/A	
Rosetta* Dimensional Wall¥	X	Random sizes available	Varies in size	84	
Rosetta* Dimensional Wedge¥	X	Random sizes available	Varies in size	N/A	
Rosetta* Kodah Wall	X	Random Sizes Available	Varies in size	N/A	
Rosetta* Kodah Wall Corner	X	21" front x 10.5" depth x 6" height	533 mm x 267 mm x 152 mm	N/A	
Rosetta* Dimensional Coping - Standard	PACKAGED LAYER	X	18" front x 12.5" depth x 2.5" height	Varies in Size	N/A
Rosetta* Dimensional Coping - Finished End		X	19" front x 12.5" depth x 2.5" height	Varies in Size	N/A
Rosetta* Dimensional Coping - Long		X	24" front x 12.5" depth x 2.5" height	Varies in Size	N/A
Rosetta* Outcropping¥		X	Wall, corner (6" & 12") available	Varies in size	222.22
Olentangy Bluff Tread™	X	36" front x 16" depth x 6" height	914 mm x 406 mm x 152 mm	N/A	
Olentangy Bluff Tread™ (Front width can vary up to 1.5")	X	48 1/2" front x 16" depth x 6" height	1257 mm x 406 mm x 152 mm	N/A	
Olentangy Bluff Tread™	X	60" front x 16" depth x 6" height	1524 mm x 406 mm x 152 mm	N/A	
Olentangy Bluff Tread™	X	72" front x 16" depth x 6" height	1829 mm x 406 mm x 152 mm	N/A	
Rosetta* Irregular Steps¥	X	42"- 60" front x 17"-28" depth x 7" height	Varies in size	N/A	
Rosetta* Dimensional Steps 3'¥	X	36" front x 18" depth x 7" height	914 mm x 457 mm x 178 mm	N/A	
Rosetta* Dimensional Steps 4'¥	X	48" front x 18" depth x 7" height	1219 mm x 457 mm x 178 mm	N/A	
Rosetta* Dimensional Steps 6'¥	X	72" front x 30" depth x 7" height	1829 mm x 762 mm x 178 mm	N/A	
Edington Wall Stone*	X	12" front x 8" depth x 4" height	300 mm x 200 mm x 100 mm	90	
Edington Wall Wedge	X	12" front x 8" depth x 4" height	300 mm x 200 mm x 100 mm	75	
Non-Tumbled Edington Wall Stone*	X	12" front x 8" depth x 4" height	300 mm x 200 mm x 100 mm	90	
Non-Tumbled Edington Wall Stone Wedge*	X	12" front x 8" depth x 4" height	300 mm x 200 mm x 100 mm	75	
Non-Weathered Versa-Lok* Standard	X	16" front x 12" depth x 6" height	406 mm x 305 mm x 152 mm	123	
Non-Weathered Versa-Lok* Smooth Top	X	16" front x 12" depth x 6" height	406 mm x 305 mm x 152 mm	123	
Non-Weathered Rectangular Retaining Wall Cap	X	16" front x 11 5/8" depth x 3 5/8" height	397 mm x 295 mm x 92 mm	51	
Non-Weathered Versa-Lok* Solid Corner†	X	7 7/8" front x 12" depth x 6" height	203 mm x 305 mm x 152 mm	41	
Non-Weathered Versa-Lok* Full Return Corner†	X	8" front x 16" depth x 6" height	203 mm x 406 mm x 152 mm	48	
Non-Weathered Versa-Lok* Cobble	X	8" front x 12" depth x 6" height	203 mm x 305 mm x 152 mm	123	
Non-Weathered Versa-Lok* Accent	X	12" front x 12" depth x 4" height	305 mm x 305 mm x 102 mm	123	
Weathered Versa-Lok* Standard	X	16" front x 12" depth x 6" height	406 mm x 305 mm x 152 mm	123	
Weathered Rectangular Retaining Wall Cap	X	16" front x 11 5/8" depth x 3 5/8" height	397 mm x 295 mm x 92 mm	51	
Weathered Versa-Lok* Solid Corner†	X	7 7/8" front x 12" depth x 6" height	203 mm x 305 mm x 152 mm	41	
Weathered Versa-Lok* Full Return Corner†	X	8" front x 16" depth x 6" height	203 mm x 406 mm x 152 mm	48	
Weathered Versa-Lok* Cobble	X	8" front x 12" depth x 6" height	203 mm x 305 mm x 152 mm	123	
Weathered Versa-Lok* Accent	X	12" front x 12" depth x 4" height	305 mm x 305 mm x 102 mm	123	

SPECIAL NOTES: * Asterisk denotes non-stocked shape or color
 ¥ Not available in Michigan
 † Also available in Weathered

UNITS PER SQ. FT.	UNITS PER BAND	UNITS PER CUBE	WEIGHT PER CUBE	SQ. FT. PER UNIT	SQ. FT. PER LAYER	SQ. FT. PER CUBE	COLOR STOCKED
N/A	N/A	N/A	2475	N/A	N/A	27.00	Cuyahoga, Scioto
N/A	N/A	N/A	1520	N/A	N/A	24.00	Cuyahoga, Scioto
N/A	N/A	N/A	1550	N/A	N/A	66.00/LNFT	Cuyahoga, Scioto
3.00	N/A	75	2100	N/A	N/A	25.00	Cuyahoga, Scioto
3.00	N/A	100	2000	N/A	N/A	N/A	Cuyahoga, Scioto
N/A	N/A	18	2400	N/A	N/A	21.00	Cuyahoga, Scioto
N/A	N/A	16	1600	N/A	N/A	21.00	Cuyahoga, Scioto
N/A	N/A	N/A	1950	N/A	N/A	63.00/LNFT	Cuyahoga, Scioto
N/A	N/A	N/A	1950	N/A	N/A	63.00/LNFT	Cuyahoga, Scioto
N/A	N/A	N/A	1950	N/A	N/A	63.00/LNFT	Cuyahoga, Scioto
N/A	N/A	N/A	4000	N/A	N/A	18.00	Cuyahoga, Scioto
N/A	N/A	8	2240	N/A	N/A	N/A	Cuyahoga, Scioto
N/A	N/A	8	2984	N/A	N/A	N/A	Cuyahoga, Scioto
N/A	N/A	6	2802	N/A	N/A	N/A	Cuyahoga, Scioto
N/A	N/A	4	2240	N/A	N/A	N/A	Cuyahoga, Scioto
N/A	N/A	6	3150	N/A	N/A	N/A	Cuyahoga, Scioto
N/A	N/A	6	2250	N/A	N/A	N/A	Cuyahoga, Scioto
N/A	N/A	6	2730	N/A	N/A	N/A	Cuyahoga, Scioto
N/A	N/A	3	3960	N/A	N/A	N/A	Cuyahoga, Scioto
3.00	N/A	100	2880	0.333	N/A	32.00	Canyon Creek, Charcoal, Desert Sand, Earth, Flagstone, Limestone, Quarrrystone
3.00	N/A	90	2400	0.333	N/A	30.00	Canyon Creek, Charcoal, Desert Sand, Earth, Flagstone, Limestone, Quarrrystone
3.00	N/A	132	2880	0.333	N/A	32.00	Canyon Creek, Charcoal, Desert Sand, Earth, Flagstone, Limestone, Quarrrystone
3.00	N/A	90	2400	0.333	N/A	30.00	Canyon Creek, Charcoal, Desert Sand, Earth, Flagstone, Limestone, Quarrrystone
1.50	N/A	32	2624	0.667	N/A	21.33	Antique, Canyon Creek, Charcoal, Chestnut, Desert Sand, Earth, Flagstone, Granite, Gray
1.50	N/A	32	2624	0.667	N/A	21.33	Antique, Canyon Creek, Charcoal, Chestnut, Desert Sand, Earth, Flagstone, Granite, Gray
N/A	N/A	48	2304	N/A	N/A	N/A	Antique, Canyon Creek, Charcoal, Chestnut, Desert Sand, Earth, Flagstone, Granite, Gray
3.00	N/A	64	2624	N/A	N/A	N/A	Antique, Canyon Creek, Charcoal, Chestnut, Desert Sand, Earth, Flagstone, Granite, Gray
N/A	N/A	48	2304	N/A	N/A	N/A	Antique, Canyon Creek, Charcoal, Chestnut, Desert Sand, Earth, Flagstone, Granite, Gray
3.00	N/A	64	2624	0.333	N/A	21.33	Canyon Creek, Earth, Flagstone, Granite
3.00	N/A	60	2422	0.333	N/A	20.00	Canyon Creek, Earth, Flagstone, Granite
1.50	N/A	32	2624	0.667	N/A	21.33	Canyon Creek, Earth, Flagstone, Granite
N/A	N/A	48	2304	N/A	N/A	N/A	Canyon Creek, Earth, Flagstone, Granite
3.00	N/A	64	2624	N/A	N/A	N/A	Canyon Creek, Earth, Flagstone, Granite
N/A	N/A	48	2304	N/A	N/A	N/A	Canyon Creek, Earth, Flagstone, Granite
3.00	N/A	64	2624	0.333	N/A	21.33	Canyon Creek, Earth, Flagstone, Granite
3.00	N/A	60	2422	0.333	N/A	20.00	Canyon Creek, Earth, Flagstone, Granite

Retaining Wall Color Blends: Antique+=black, red; Canyon Creek= buff, charcoal, maroon; Chestnut=buff, brown; Earth=brown, buff, charcoal; Flagstone=buff, charcoal, gray; Granite=charcoal, gray





WHAT OUTDOOR LIVING SHOULD BE[®]

OBERFIELDS CONCRETE PAVER & RETAINING WALLS WARRANTY

OBERFIELDS provides a limited lifetime warranty of its paver, slab, and dry cast wall products and Rosetta[®] family of precast products for residential applications against manufacturing defects. This Warranty is provided to the original purchaser only, with the original proof of purchase, and is non-transferable.

This Warranty is valid if the material is installed and maintained under industry standards or OBERFIELDS LLC guidelines. Color variances and the appearance of efflorescence do not substantiate a warranty claim. Any product deemed to be defective will be replaced at no charge; however, shipping costs or costs relating to the removal of defective material and replacement labor are not included in this warranty. Color matching cannot be guaranteed.

oberfields.com 800.845.7644



SALES - CORPORATE OFFICE

Masonry, Landscape & Precast

528 London Road
Delaware, Ohio 43015
614-252-0955
740-369-7644
800-845-7644
Fax 740-363-7644

SALES & MANUFACTURING

Masonry, Landscape & Precast

4033 Alum Creek Drive
Obetz, Ohio 43207
614-252-0955
Fax 614-252-5858

Masonry, Landscape & Precast

10075 Sheehan Road
Centerville, Ohio 45458
937-885-3711
Fax 937-885-4355



oberfields.com