

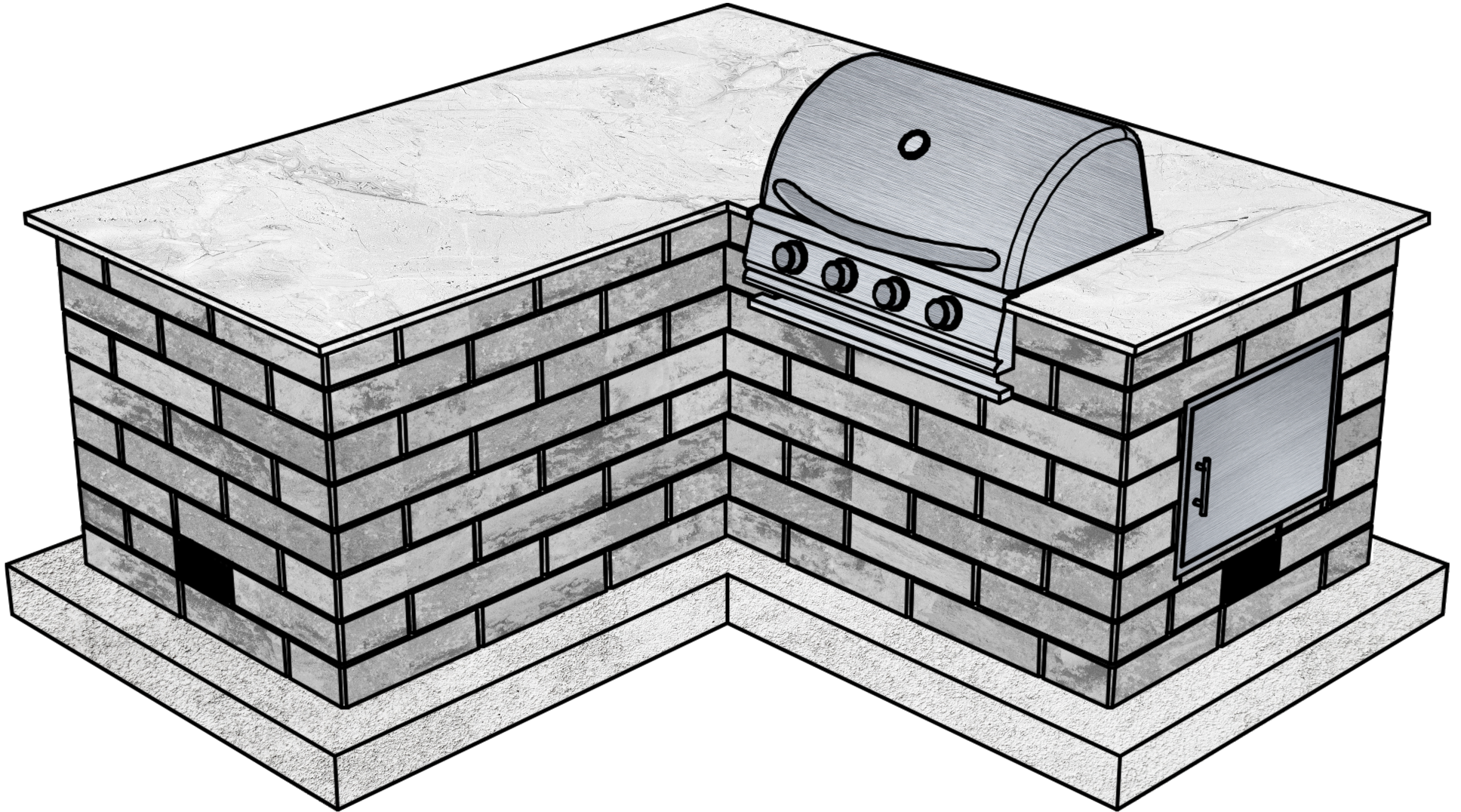

**oberfields**<sup>TM</sup>  
A QUIKRETE® COMPANY



# LENZA

45 X 99 L-SHAPE GRILL TOP - RIGHT DOOR DESIGN

# LENZA - 45 x 99 L-SHAPE GRILL TOP - RIGHT DOOR DESIGN

# OUTDOOR LIVING DESIGNS

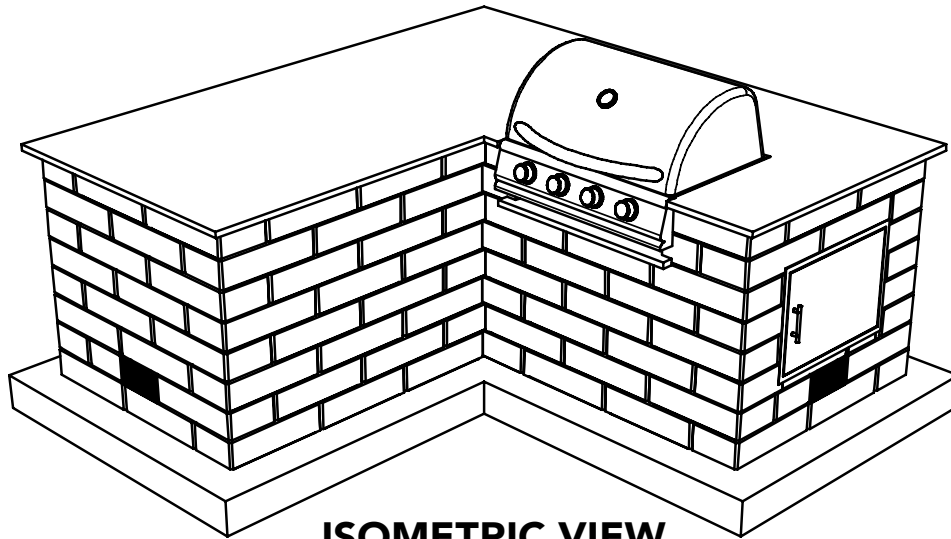

**ISOMETRIC VIEW**

**NOTE:**

1. WALL UNITS TO BE INSTALLED WITH CHANNEL ON THE BOTTOM SIDE IN ORDER TO GET THE PROPER CONTEMPORARY ESTHETIC LOOK. (WALL PRODUCT TO BE INVERTED 180 DEGREES FROM FINISHED PALLET WHEN INSTALLED).
2. SECURE EACH UNIT USING APPROVED ADHESIVE OR BONDING AGENT FOLLOWING APPLICATION DIRECTIONS PROVIDED BY PRODUCT SUPPLIER.
3. THIS DESIGN REQUIRES CUTTING UNITS TO PROPERLY FIT THE GRILL TOP AND ACCESS DOOR.
4. BUILT-IN GRILL INSERT AND ACCESS DOOR TO BE INSTALLED PER MANUFACTURES RECOMMENDATIONS.
5. STRUCTURAL SUPPORT FOR BLOCK UNITS OVER OPENINGS NOT SHOWN FOR VISUAL PURPOSES.
6. FOR PROPER INSTALLATION OF GAS GRILL REFER TO BLAZE OUTDOOR PRODUCTS - USE & CARE GUIDE GAS GRILLS BLZ-4LBM (NG/LP).

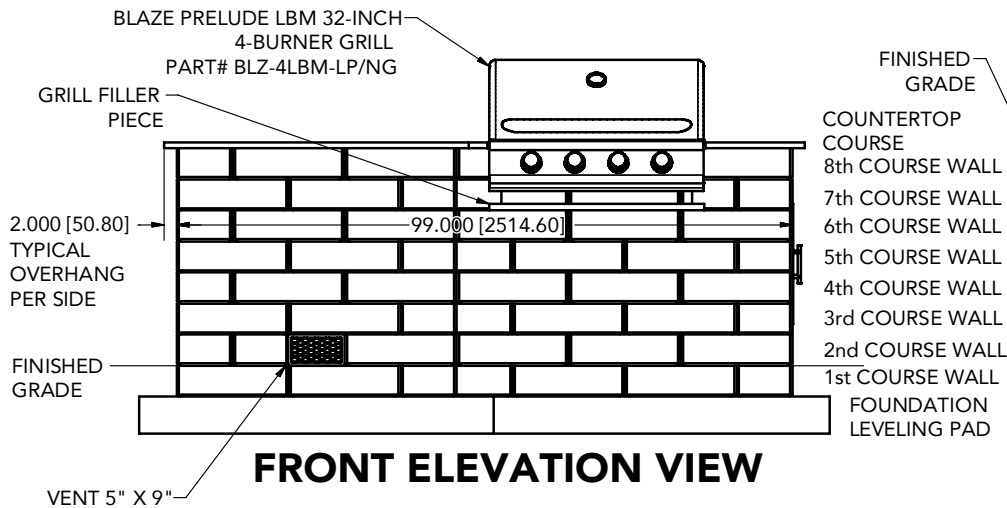

**FRONT ELEVATION VIEW**

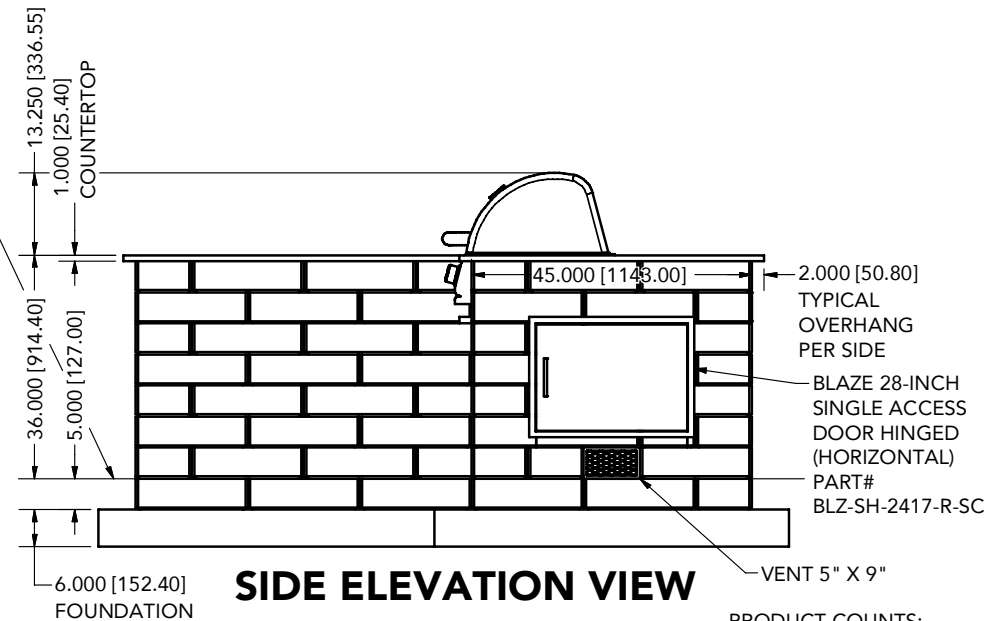

**SIDE ELEVATION VIEW**

**PRODUCT COUNTS:**  
(160) TOTAL WALL UNITS

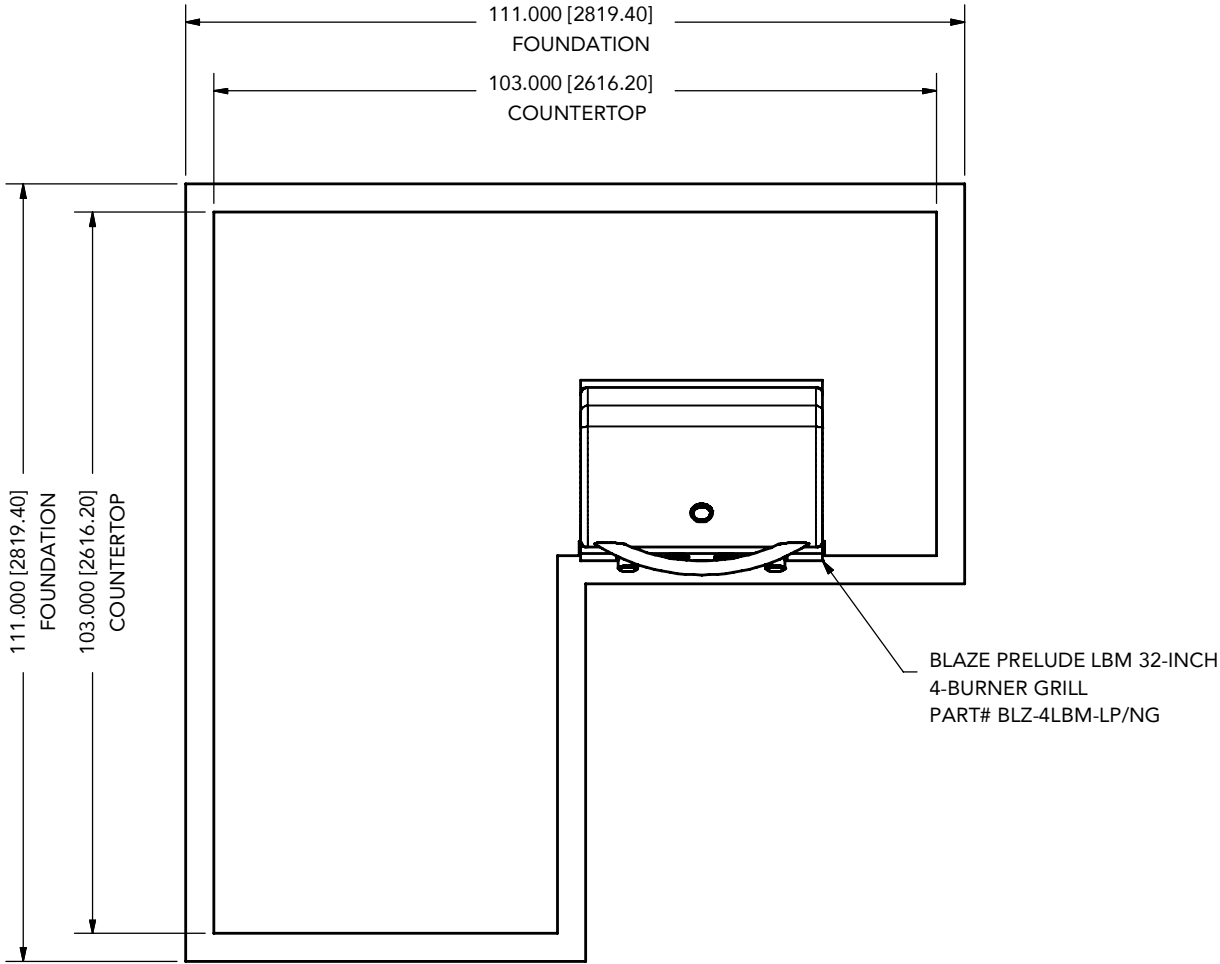

PLAN VIEW

LENZA - 45 x 99 L-SHAPE GRILL TOP - RIGHT DOOR DESIGN

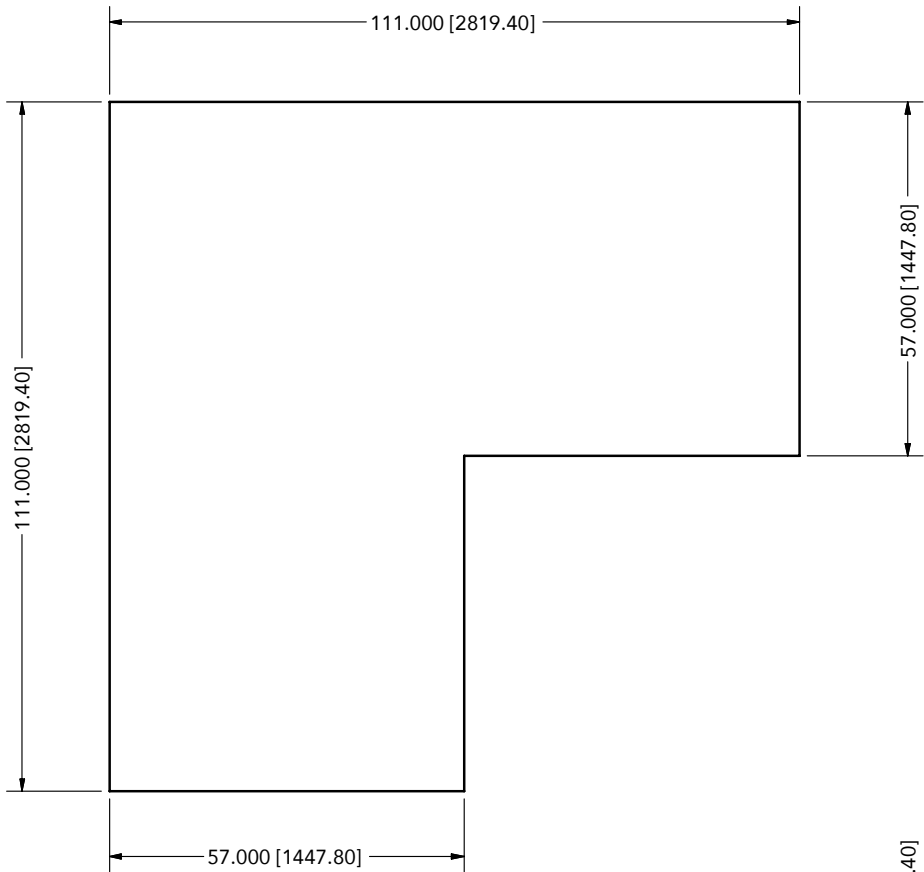

PLAN VIEW

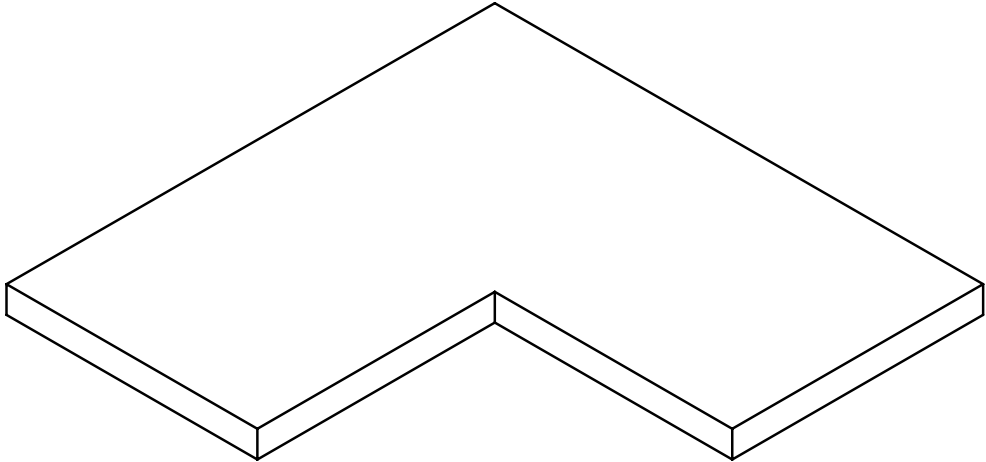

ISOMETRIC VIEW



FRONT ELEVATION VIEW



CRUSHED STONE  
OR REINFORCED  
CONCRETE  
LEVELING PAD

LENZA - 45 x 99 L-SHAPE GRILL TOP - RIGHT DOOR CUT DESIGN - FOUNDATION LEVELING PAD

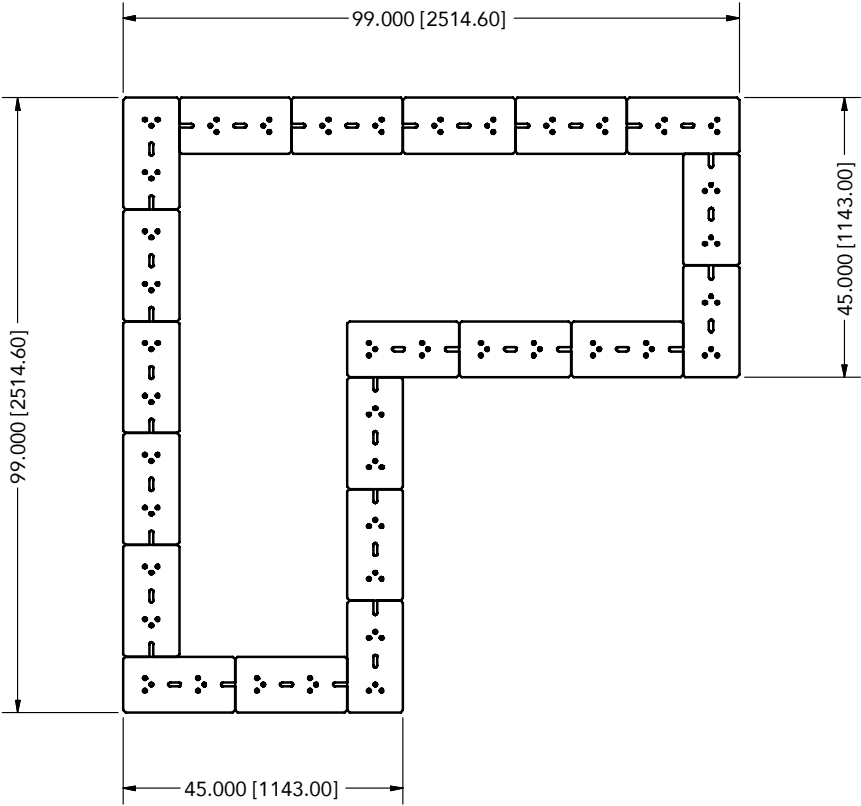

PLAN VIEW

NOTE:  
 1. WALL UNITS TO BE INSTALLED WITH CHANNEL ON THE BOTTOM SIDE  
 (PRODUCT IS TO BE INVERTED 180 DEGREES FROM FINISHED PALLET).

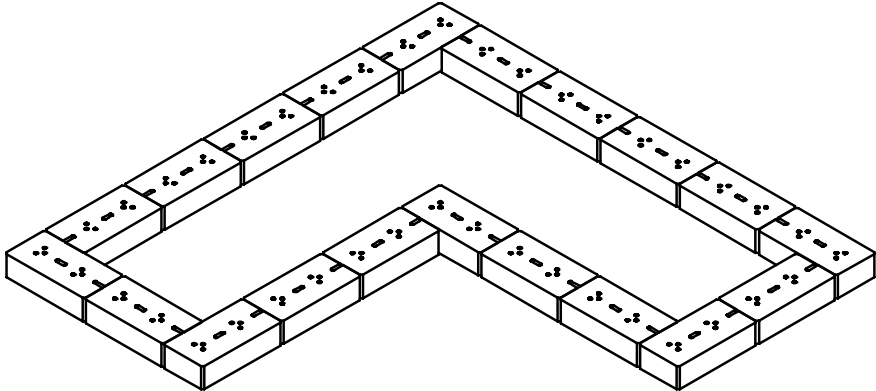

ISOMETRIC VIEW

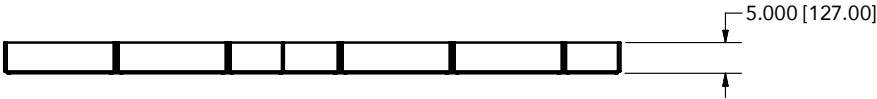

FRONT ELEVATION VIEW



SIDE ELEVATION VIEW

PRODUCT COUNTS:  
 (20) TOTAL WALL UNITS

LENZA - 45 x 99 L-SHAPE GRILL TOP - RIGHT DOOR CUT DESIGN - 1st COURSE

# LENZA - 45 x 99 L-SHAPE GRILL TOP - RIGHT DOOR DESIGN

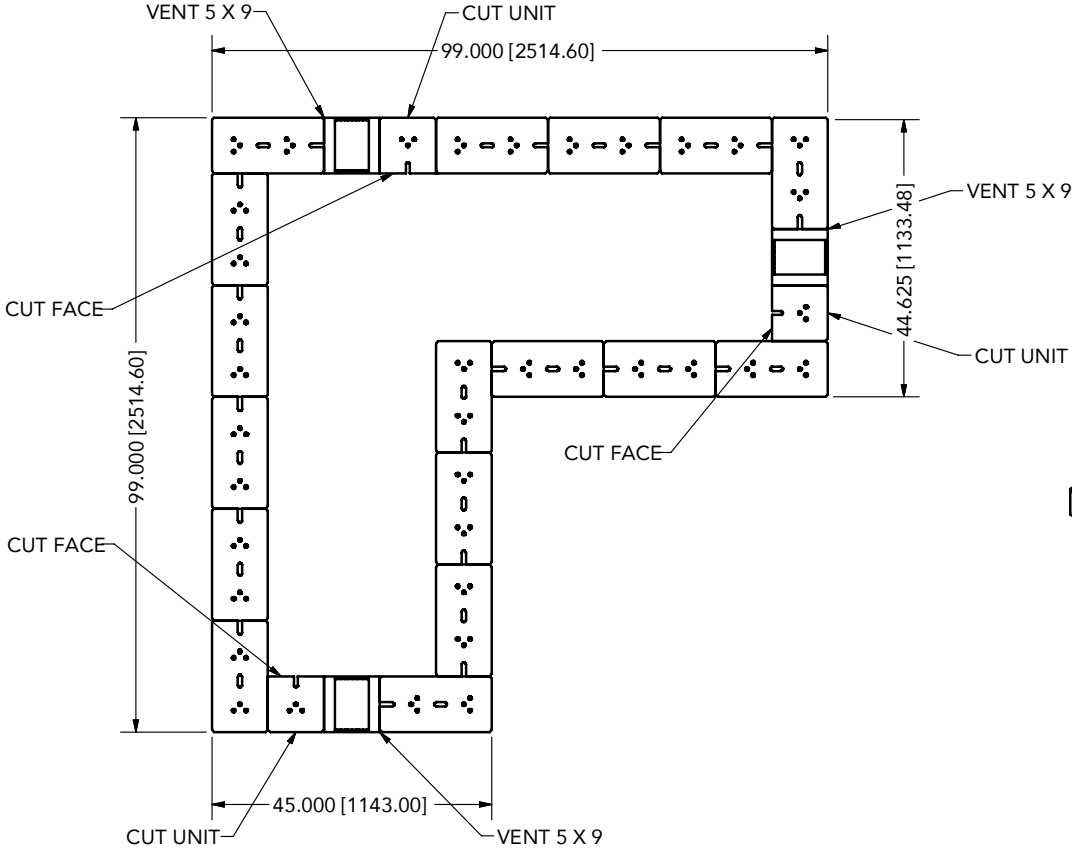

NOTE:  
 1. WALL UNITS TO BE INSTALLED WITH CHANNEL ON THE BOTTOM SIDE  
 (PRODUCT IS TO BE INVERTED 180 DEGREES FROM FINISHED PALLET).

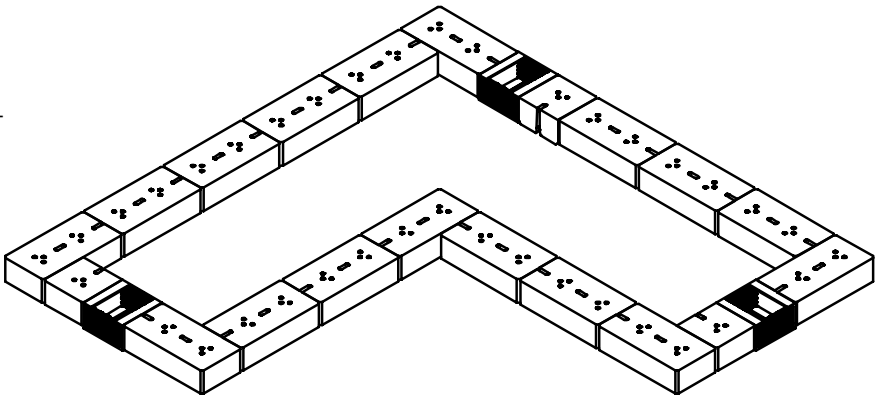

ISOMETRIC VIEW

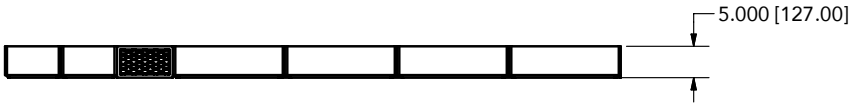

FRONT ELEVATION VIEW

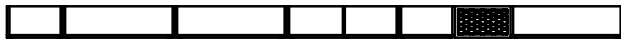

SIDE ELEVATION VIEW

## LENZA - 45 x 99 L-SHAPE GRILL TOP - RIGHT DOOR CUT DESIGN - 2nd COURSE

PRODUCT COUNTS:  
 (20) TOTAL WALL UNITS

# LENZA - 45 x 99 L-SHAPE GRILL TOP - RIGHT DOOR DESIGN

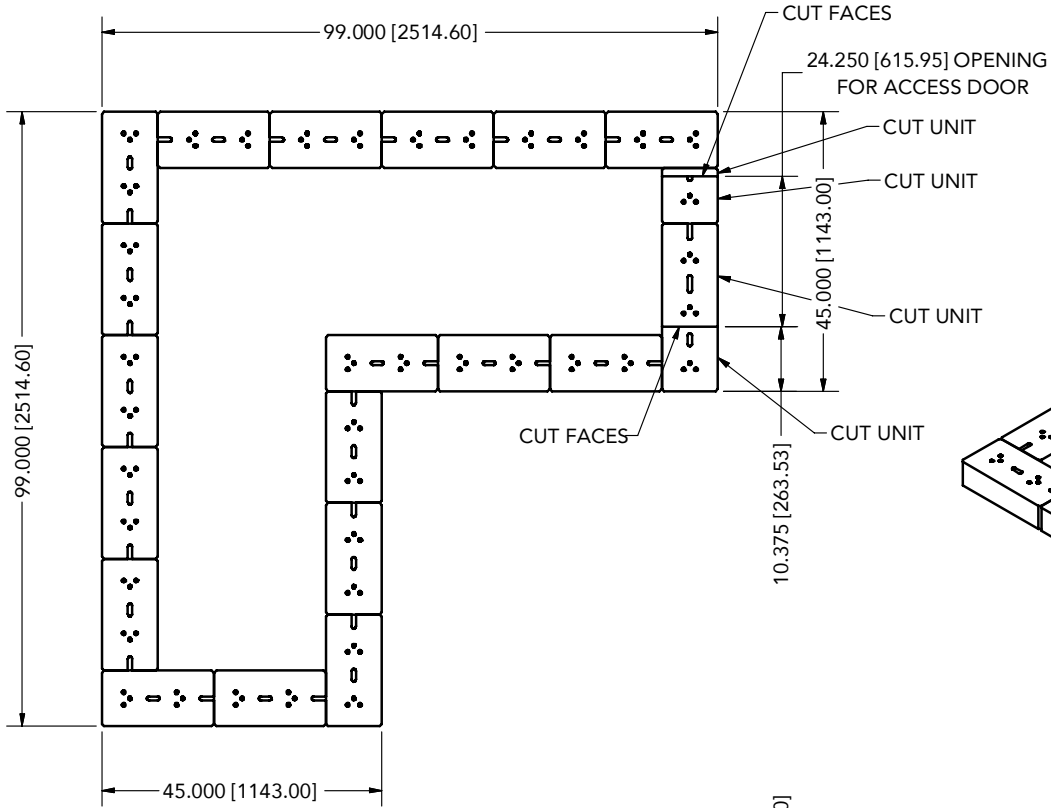

**PLAN VIEW**

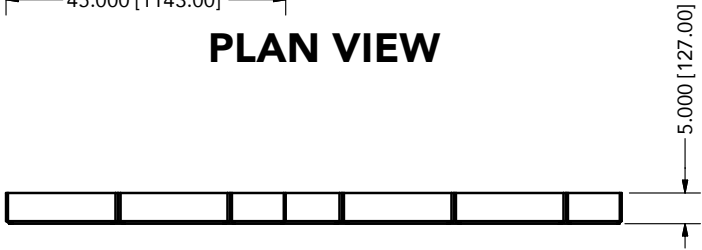

**SIDE ELEVATION VIEW**

NOTE:  
1. WALL UNITS TO BE INSTALLED WITH CHANNEL ON THE BOTTOM SIDE (PRODUCT IS TO BE INVERTED 180 DEGREES FROM FINISHED PALLET).

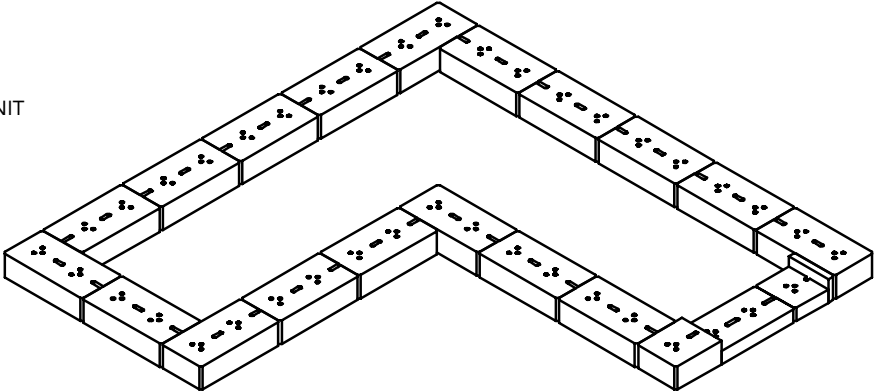

**ISOMETRIC VIEW**

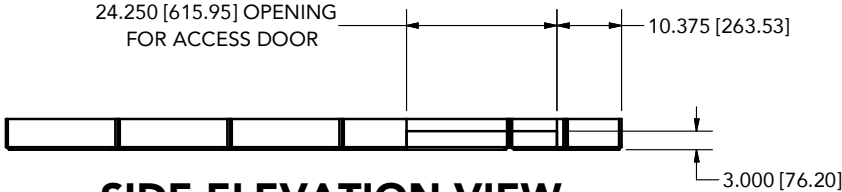

**SIDE ELEVATION VIEW**

## LENZA - 45 x 99 L-SHAPE GRILL TOP - RIGHT DOOR CUT DESIGN - 3rd COURSE

PRODUCT COUNTS:  
(22) TOTAL WALL UNITS

# LENZA - 45 x 99 L-SHAPE GRILL TOP - RIGHT DOOR DESIGN

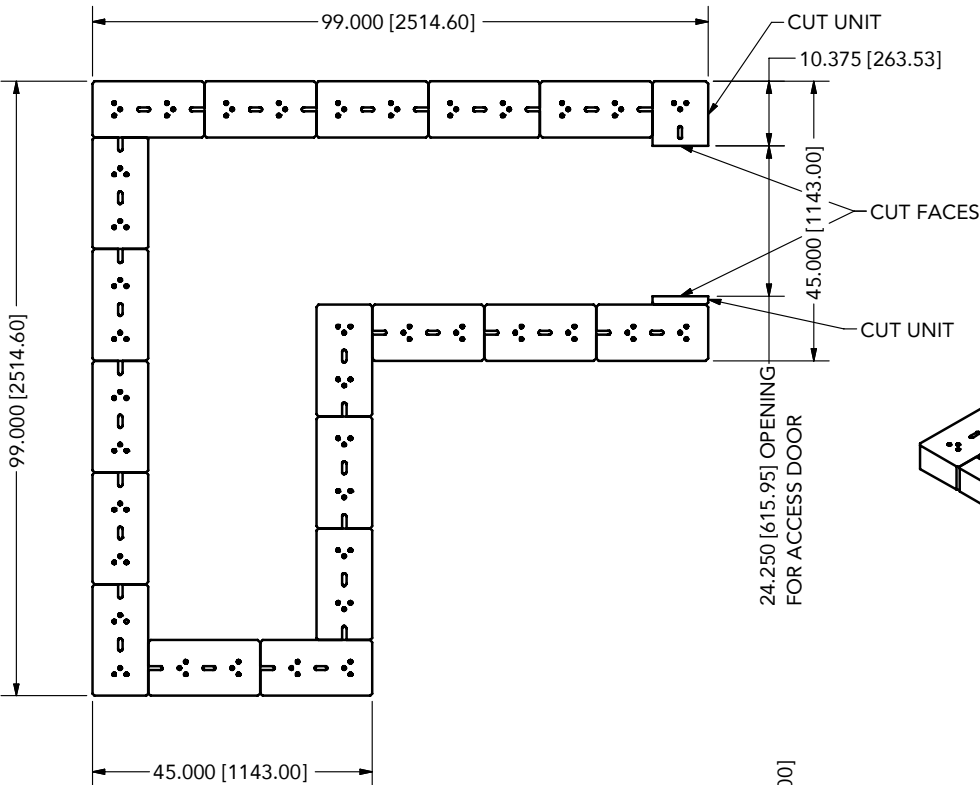

**PLAN VIEW**

NOTE:  
1. WALL UNITS TO BE INSTALLED WITH CHANNEL ON THE BOTTOM SIDE  
(PRODUCT IS TO BE INVERTED 180 DEGREES FROM FINISHED PALLET).

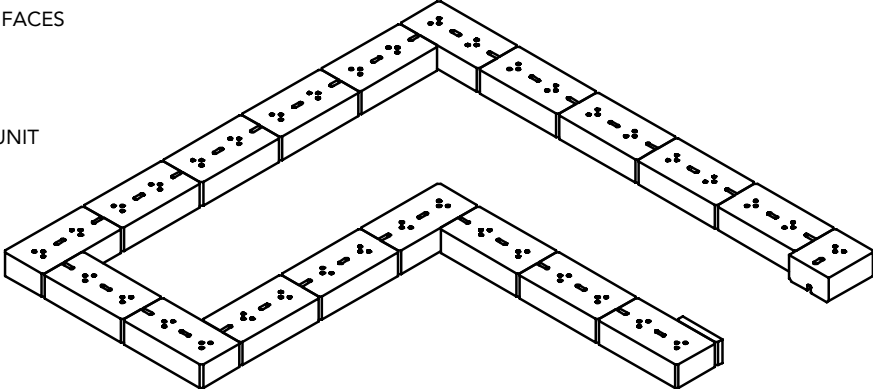

**ISOMETRIC VIEW**

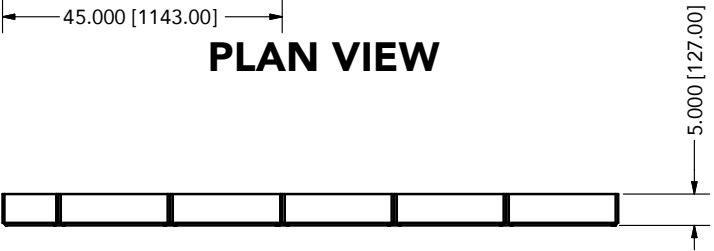

**FRONT ELEVATION VIEW**

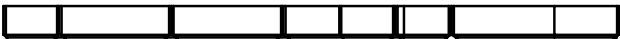

**SIDE ELEVATION VIEW**

PRODUCT COUNTS:  
(20) TOTAL CAP UNITS

## LENZA - 45 x 99 L-SHAPE GRILL TOP - RIGHT DOOR CUT DESIGN - 4th AND 6th COURSES

**LENZA - 45 x 99 L-SHAPE GRILL TOP - RIGHT DOOR DESIGN**

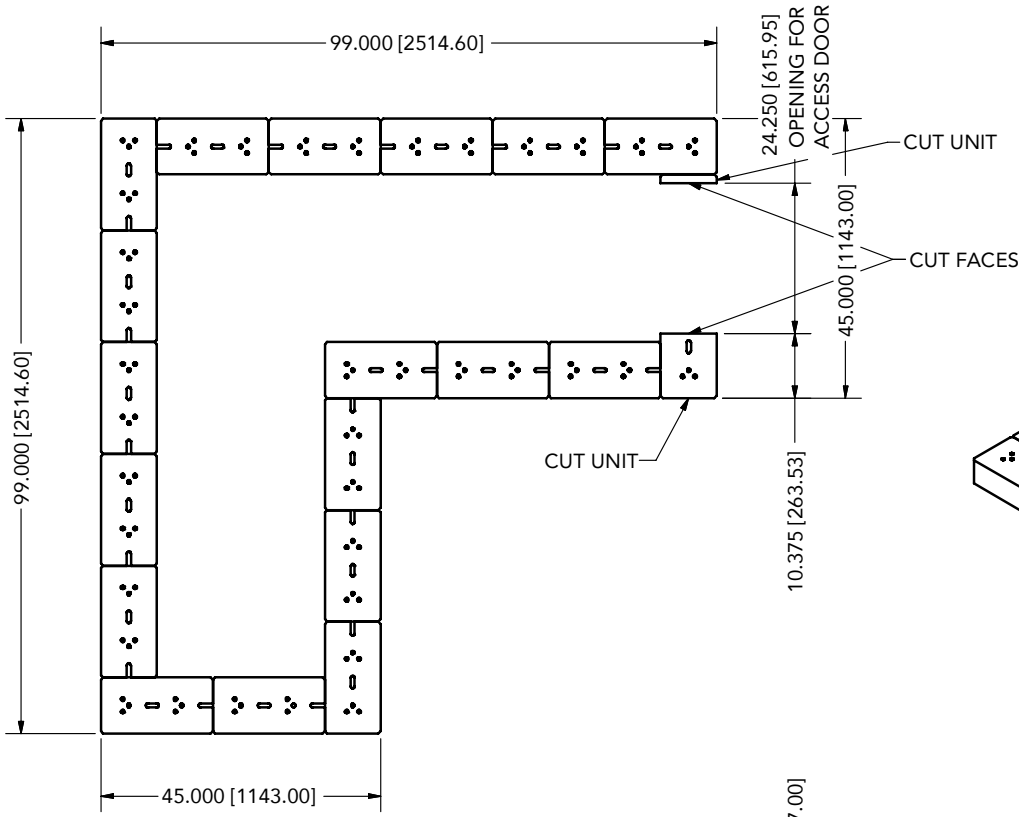

NOTE:  
 1. WALL UNITS TO BE INSTALLED WITH CHANNEL ON THE BOTTOM SIDE  
 (PRODUCT IS TO BE INVERTED 180 DEGREES FROM FINISHED PALLET).

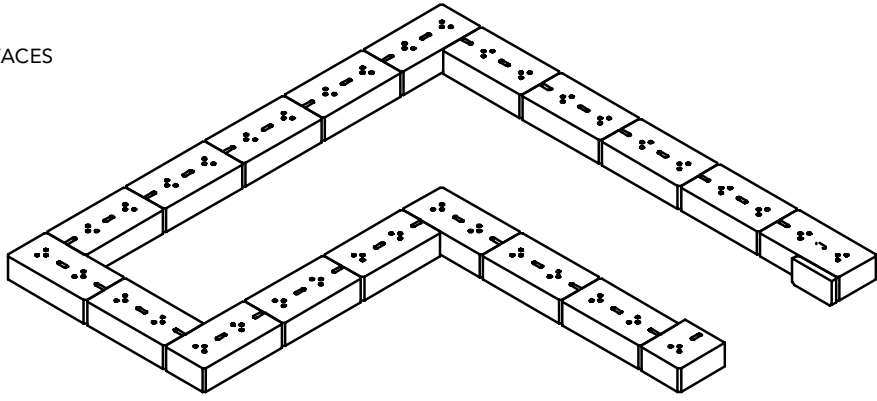

**ISOMETRIC VIEW**

**PLAN VIEW**



**FRONT ELEVATION VIEW**



**SIDE ELEVATION VIEW**

PRODUCT COUNTS:  
 (20) TOTAL CAP UNITS

**LENZA - 45 x 99 L-SHAPE GRILL TOP - RIGHT DOOR CUT DESIGN - 5th COURSE**

# LENZA - 45 x 99 L-SHAPE GRILL TOP - RIGHT DOOR DESIGN

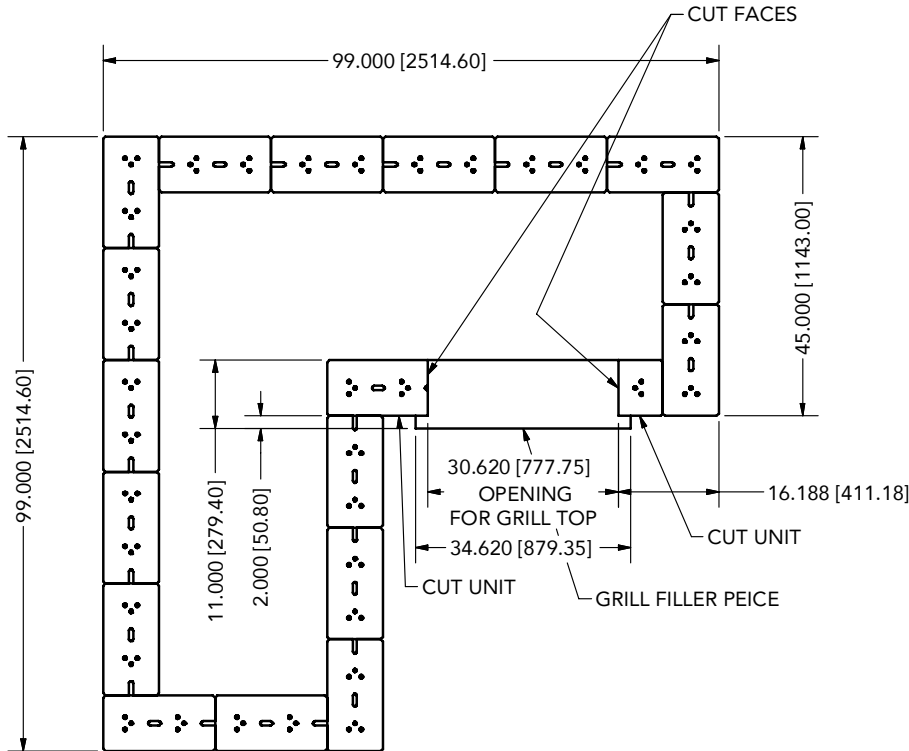

**PLAN VIEW**

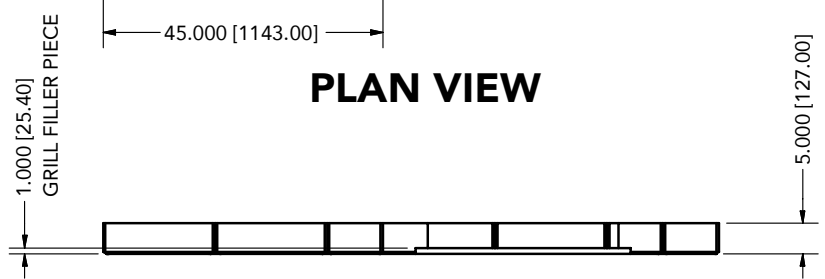

**FRONT ELEVATION VIEW**

- NOTE:
1. WALL UNITS TO BE INSTALLED WITH CHANNEL ON THE BOTTOM SIDE (PRODUCT IS TO BE INVERTED 180 DEGREES FROM FINISHED PALLET).
  2. GRILL FILLER PIECE IS TO BE MADE FROM THE SAME MATERIAL AS THE COUNTER TOP, (1" ± THICK).
  3. UNLESS OTHERWISE DIRECTED INSTALL AND SECURE GRILL FILLER PIECE WITH APPROVED ADHESIVE OR BONDING AGENT.

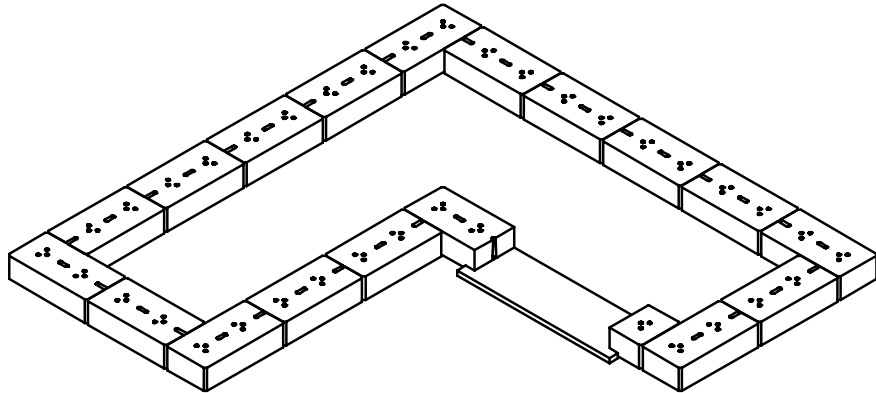

**ISOMETRIC VIEW**



**SIDE ELEVATION VIEW**

PRODUCT COUNTS:  
(19) TOTAL WALL UNITS

## LENZA - 45 x 99 L-SHAPE GRILL TOP - RIGHT DOOR CUT DESIGN - 7th COURSE

**LENZA - 45 x 99 L-SHAPE GRILL TOP - RIGHT DOOR DESIGN**

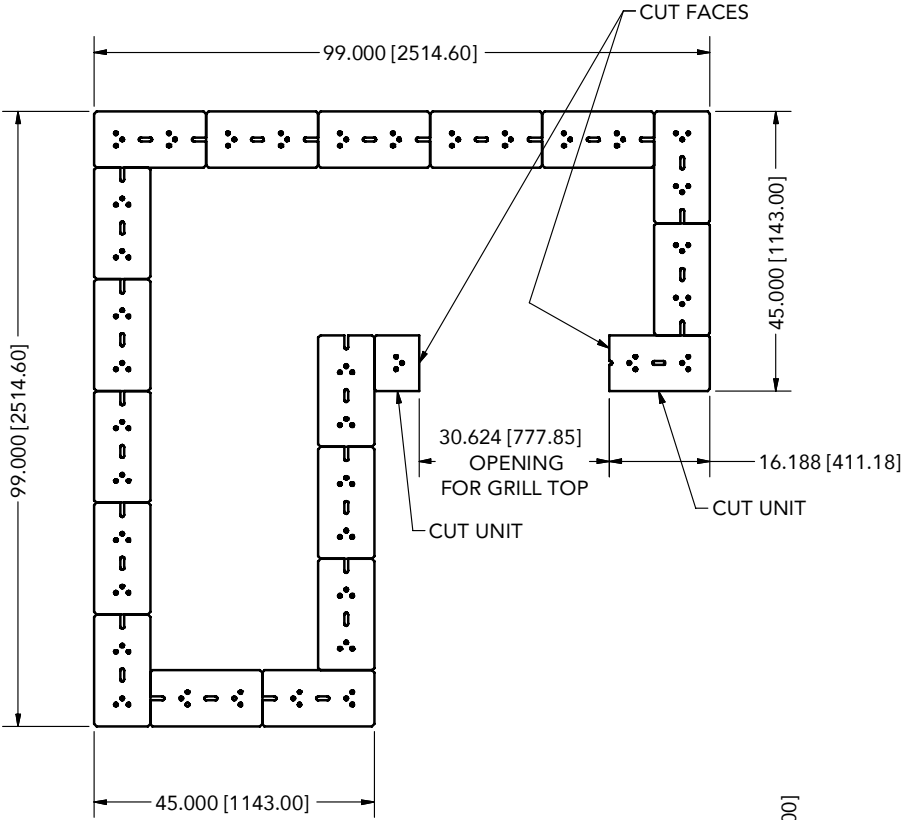

**PLAN VIEW**

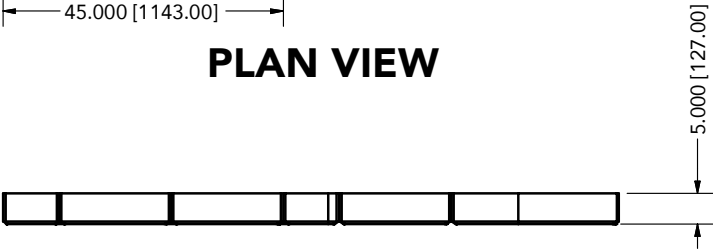

**FRONT ELEVATION VIEW**

NOTE:  
 1. WALL UNITS TO BE INSTALLED WITH CHANNEL ON THE BOTTOM SIDE  
 (PRODUCT IS TO BE INVERTED 180 DEGREES FROM FINISHED PALLET).

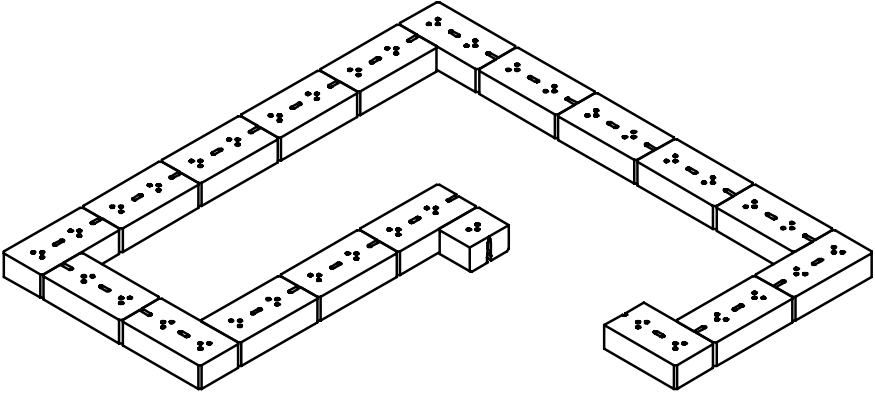

**ISOMETRIC VIEW**

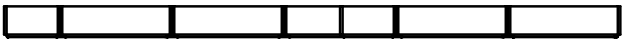

**SIDE ELEVATION VIEW**

PRODUCT COUNTS:  
 (19) TOTAL WALL UNITS

**LENZA - 45 x 99 L-SHADE GRILL TOP - RIGHT DOOR CUT DESIGN - 8th COURSE**

**LENZA - 45 x 99 L-SHAPE GRILL TOP - RIGHT DOOR DESIGN**

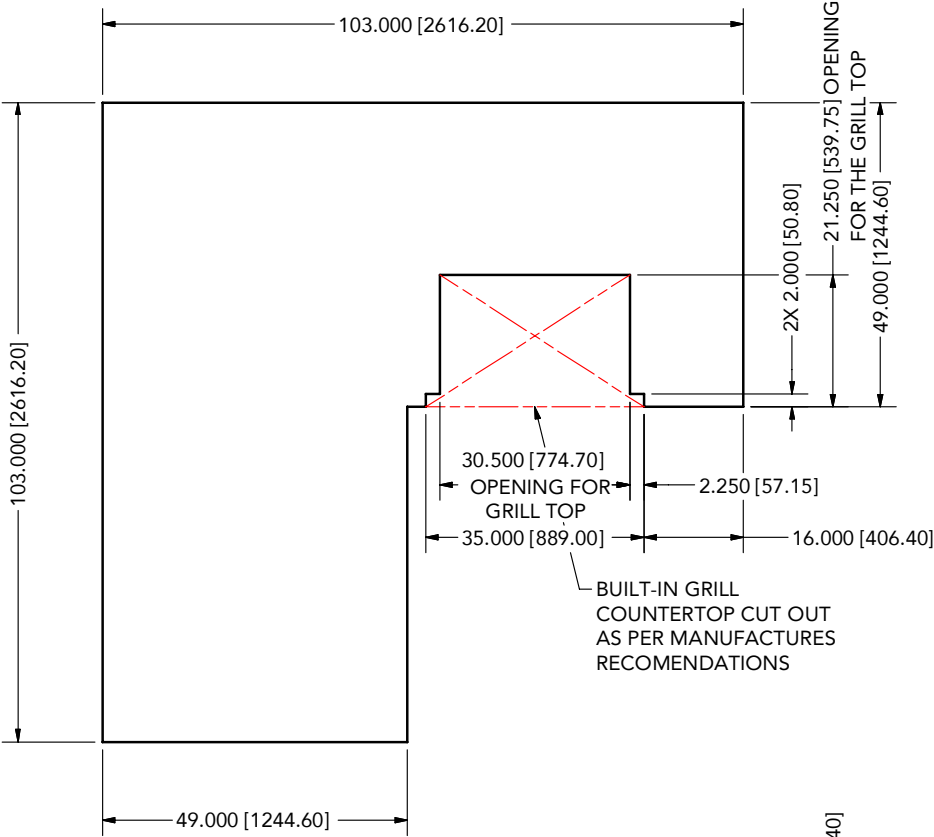

**PLAN VIEW**

NOTE:  
1. UNLESS OTHERWISE DIRECTED INSTALL AND SECURE COUNTERTOP WITH APPROVED ADHESIVE OR BONDING AGENT.

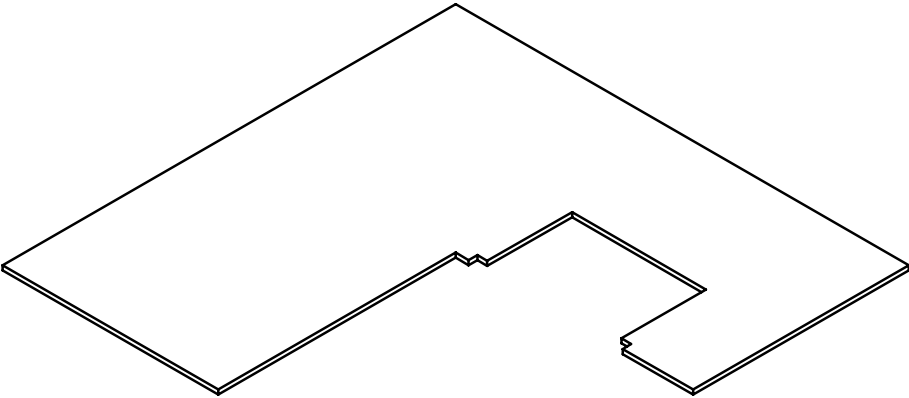

**ISOMETRIC VIEW**

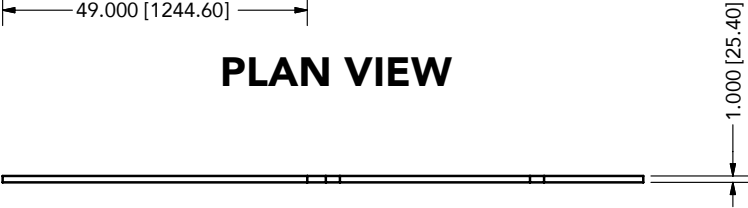

**FRONT ELEVATION VIEW**



**SIDE ELEVATION VIEW**

**LENZA - 45 x 99 L-SHAPE GRILL TOP - RIGHT DOOR CUT DESIGN - COUNTERTOP COURSE**