

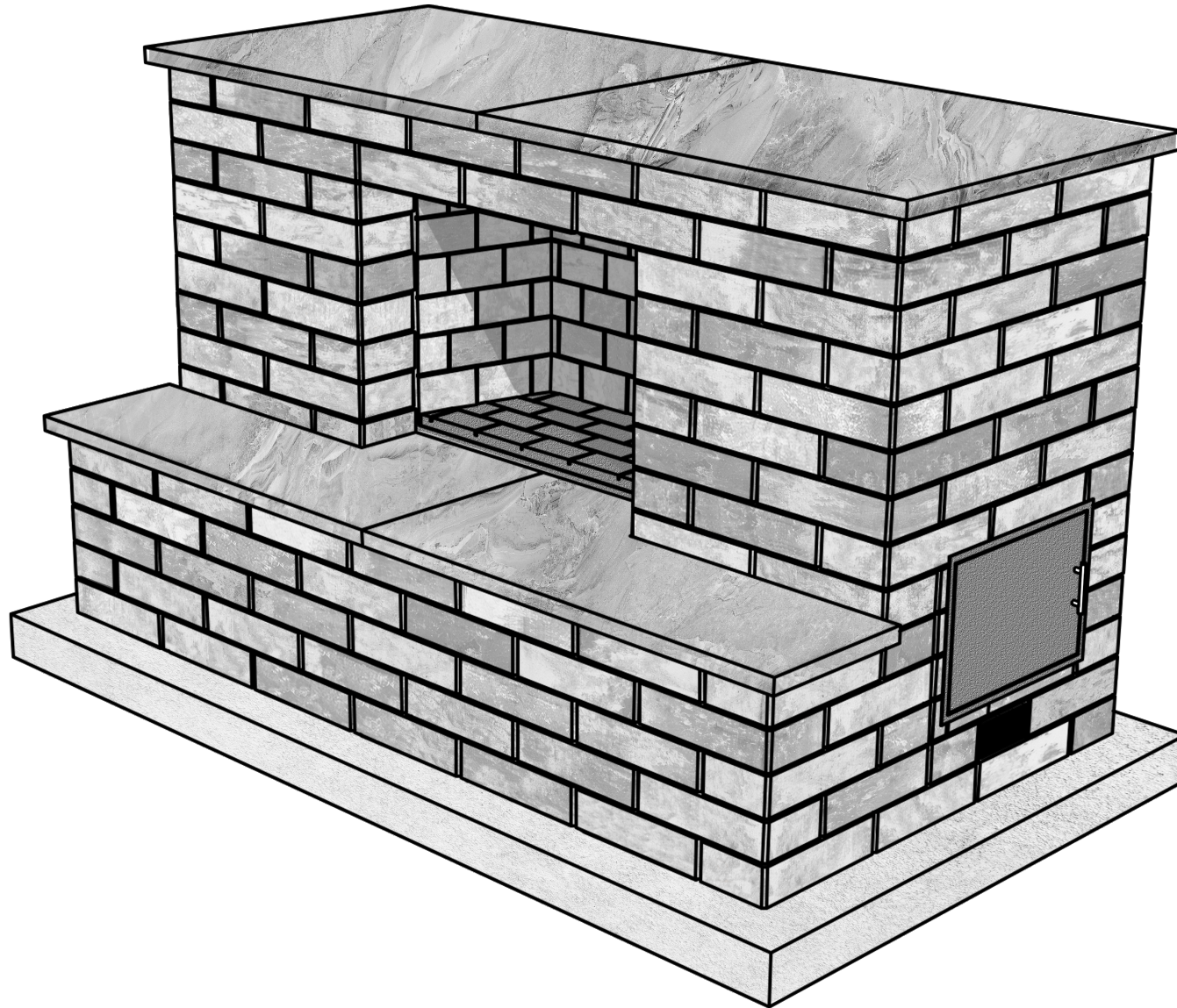

**oberfields**<sup>TM</sup>  
A QUIKRETE® COMPANY



# LENZA

63 x 117 FIREPLACE - RIGHT ACCESS DOOR DESIGN

# LENZA - 63 x 117 FIREPLACE - RIGHT ACCESS DOOR DESIGN

OUTDOOR LIVING DESIGNS

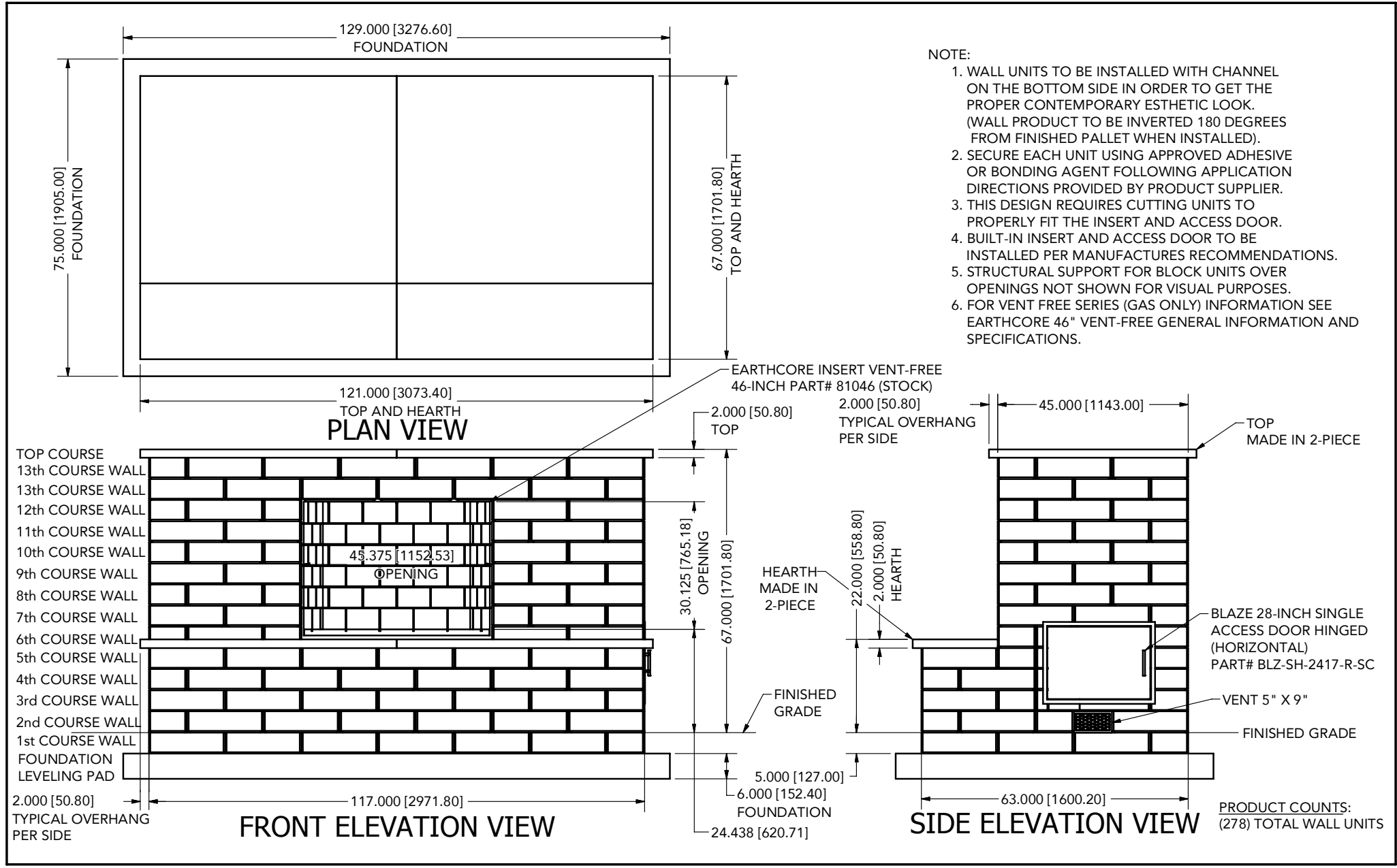

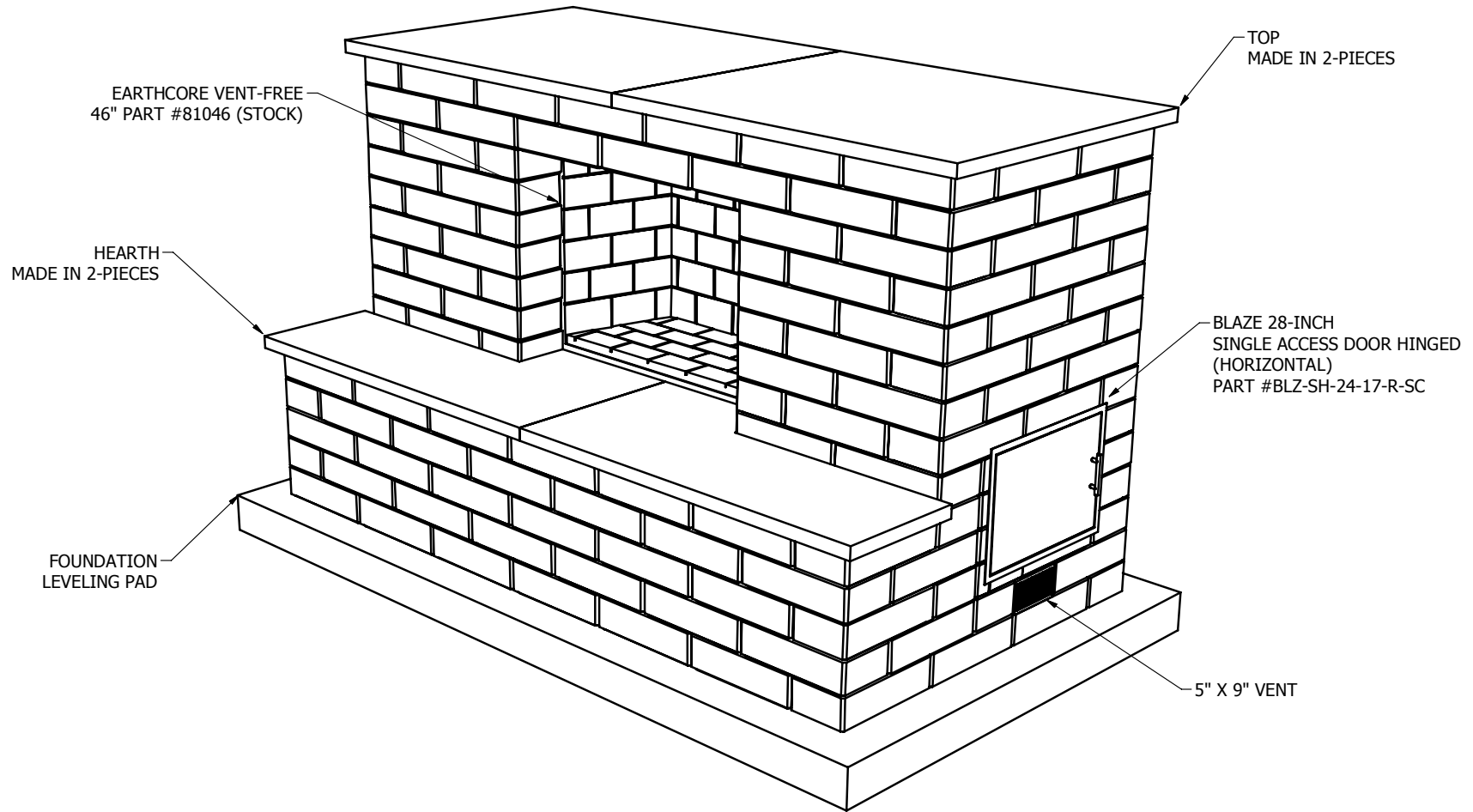

**ISOMETRIC VIEW**

**LENZA - 63 x 117 FIREPLACE - RIGHT ACCESS DOOR DESIGN - ISOMETRIC VIEW**

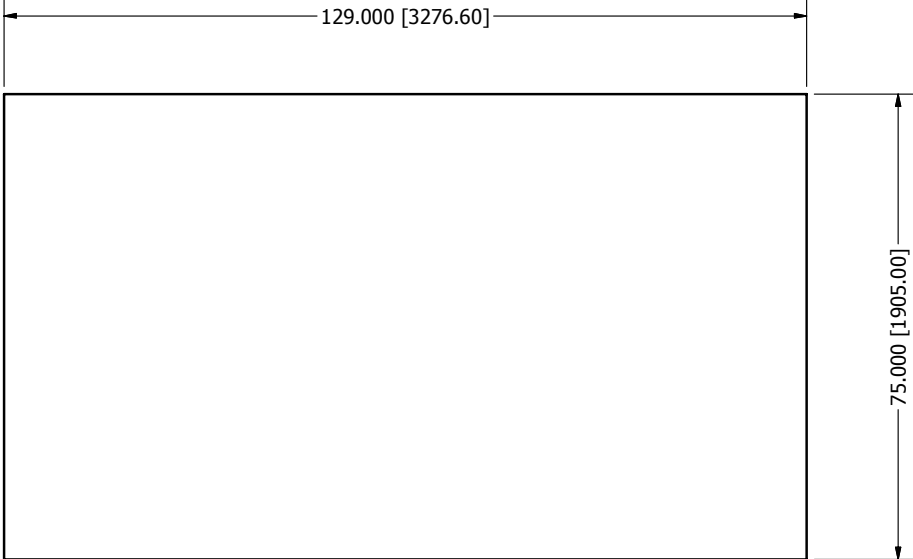

PLAN VIEW

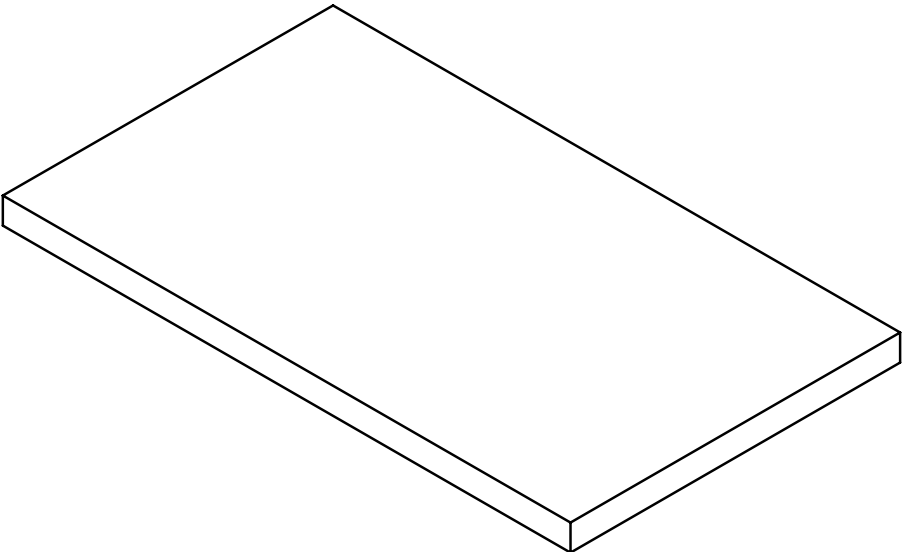

ISOMETRIC VIEW



FRONT ELEVATION VIEW



SIDE ELEVATION VIEW

LENZA - 63 x 117 FIREPLACE - RIGHT ACCESS DOOR DESIGN - FOUNDATION LEVELING PAD

# LENZA - 63 x 117 FIREPLACE - RIGHT ACCESS DOOR DESIGN

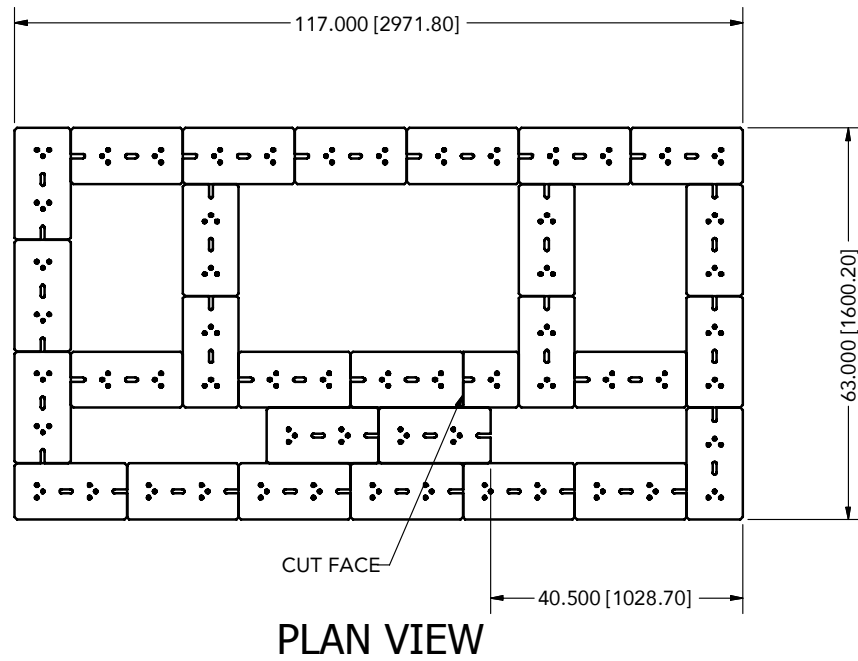

NOTE:  
1. WALL UNITS TO BE INSTALLED WITH CHANNEL ON THE BOTTOM SIDE  
(PRODUCT IS TO BE INVERTED 180 DEGREES FROM FINISHED PALLET).

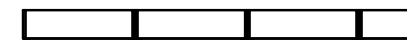
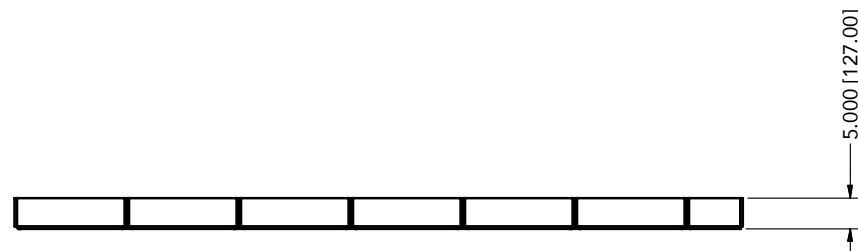
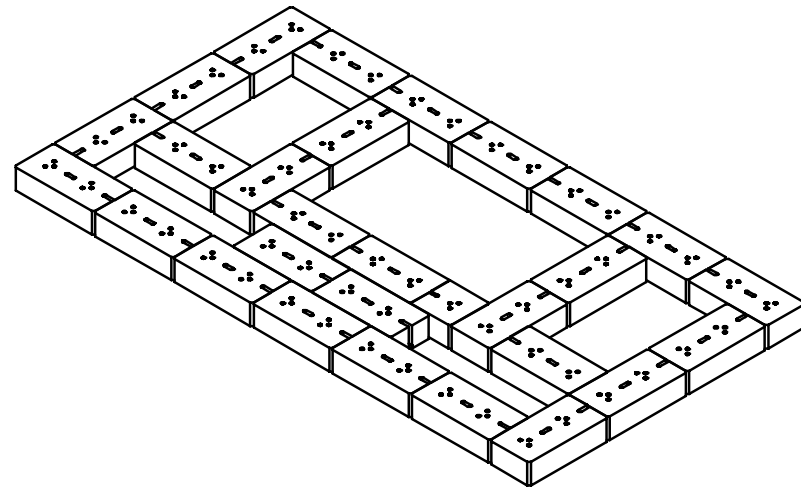

**LENZA - 63 x 117 FIREPLACE - RIGHT ACCESS DOOR DESIGN - 1st COURSE**

PRODUCT COUNTS:  
(28) TOTAL WALL UNITS

**LENZA - 63 x 117 FIREPLACE - RIGHT ACCESS DOOR DESIGN**

**OUTDOOR LIVING DESIGNS**

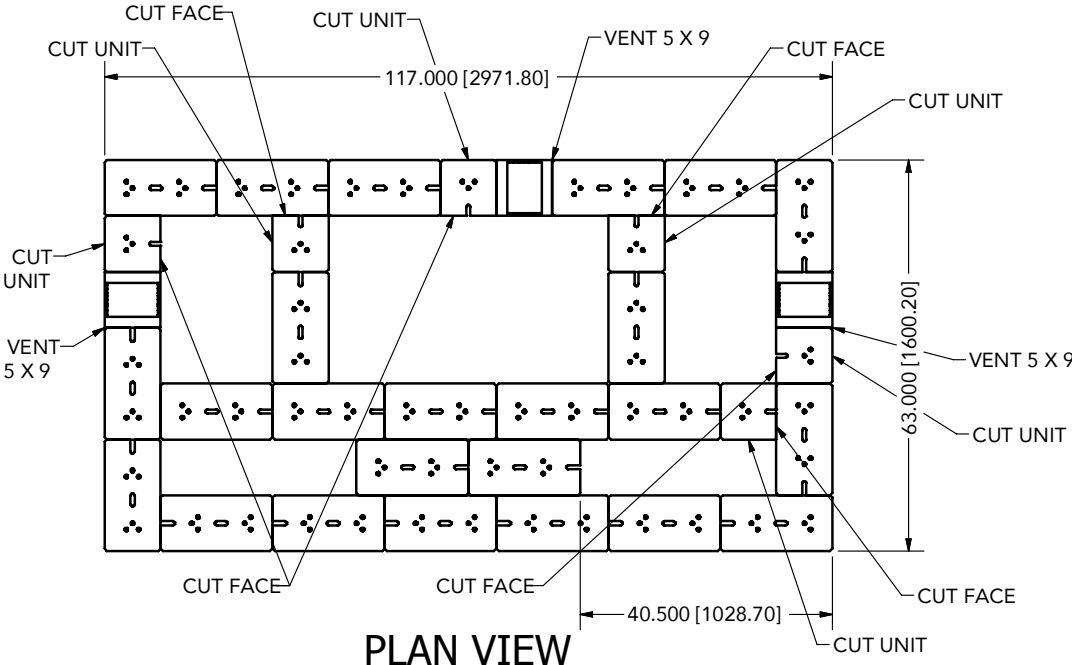

**PLAN VIEW**

NOTE:  
1. WALL UNITS TO BE INSTALLED WITH CHANNEL ON THE BOTTOM SIDE (PRODUCT IS TO BE INVERTED 180 DEGREES FROM FINISHED PALLET).

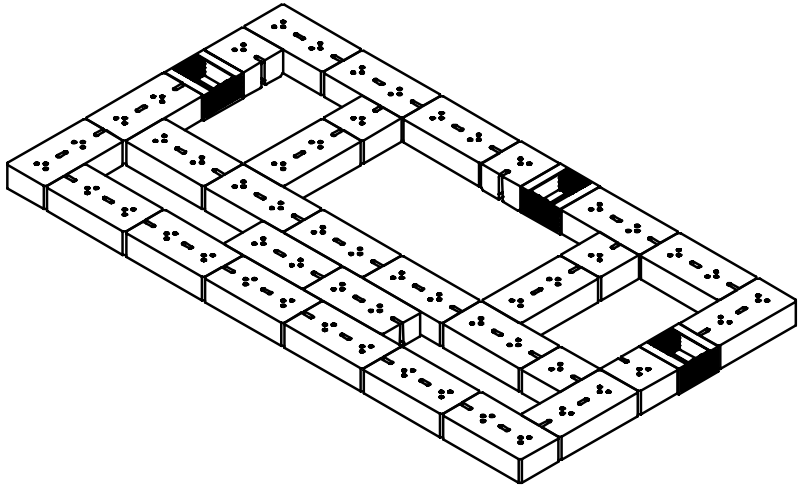

**ISOMETRIC VIEW**

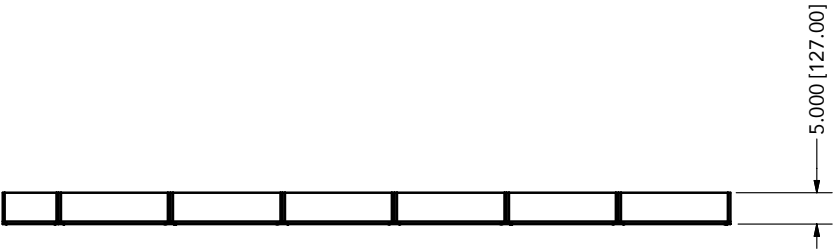

**FRONT ELEVATION VIEW**



**SIDE ELEVATION VIEW**

PRODUCT COUNTS:  
(30) TOTAL WALL UNITS

**LENZA - 63 x 117 FIREPLACE - RIGHT ACCESS DOOR DESIGN - 2nd COURSE**

# LENZA - 63 x 117 FIREPLACE - RIGHT ACCESS DOOR DESIGN

NOTE:  
 1. WALL UNITS TO BE INSTALLED WITH CHANNEL ON THE BOTTOM SIDE  
 (PRODUCT IS TO BE INVERTED 180 DEGREES FROM FINISHED PALLET).

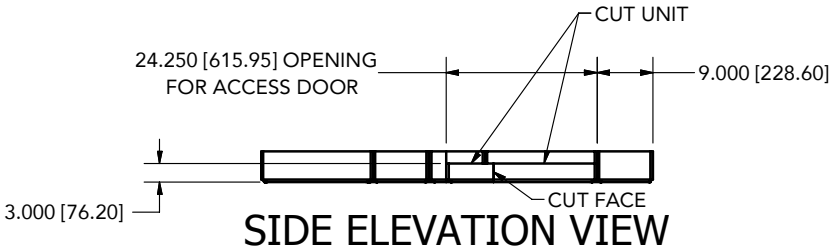
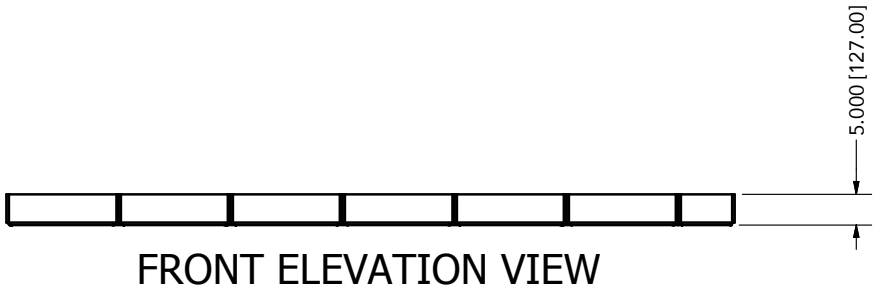
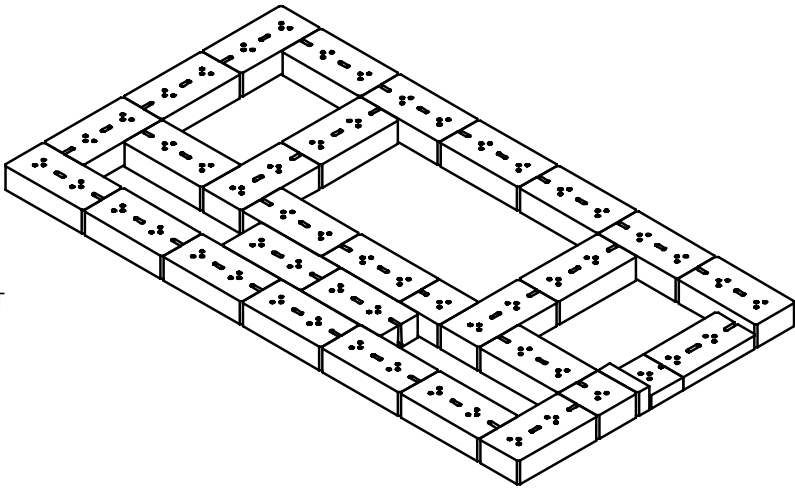
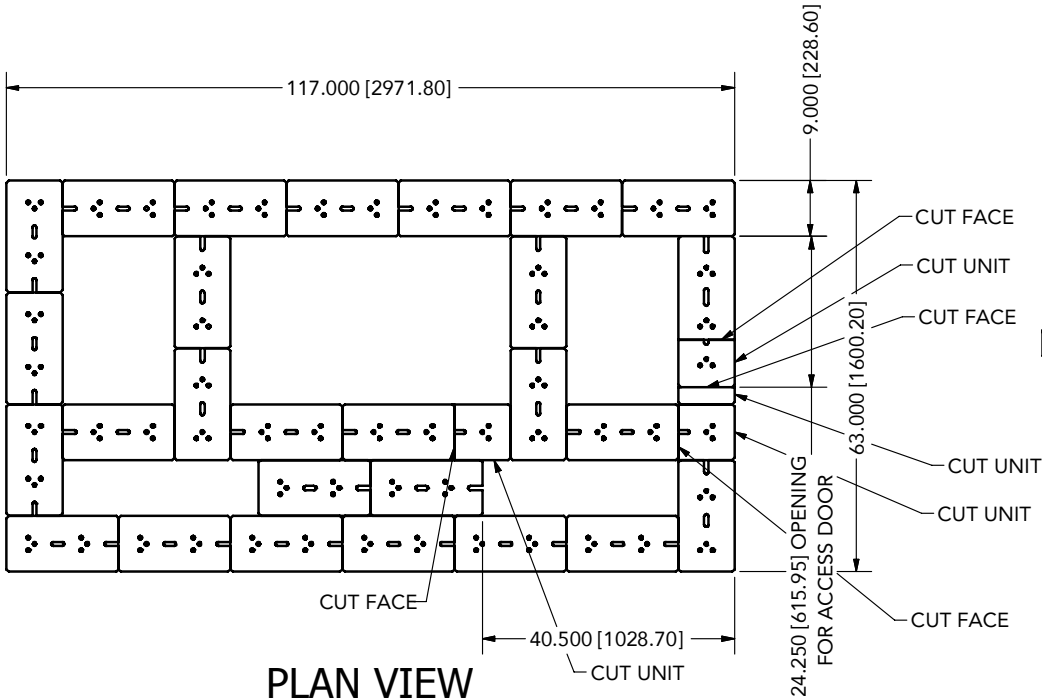

PRODUCT COUNTS:  
 (31) TOTAL WALL UNITS

## LENZA - 63 x 117 FIREPLACE - RIGHT ACCESS DOOR DESIGN - 3rd COURSE

**LENZA - 63 x 117 FIREPLACE - RIGHT ACCESS DOOR DESIGN**

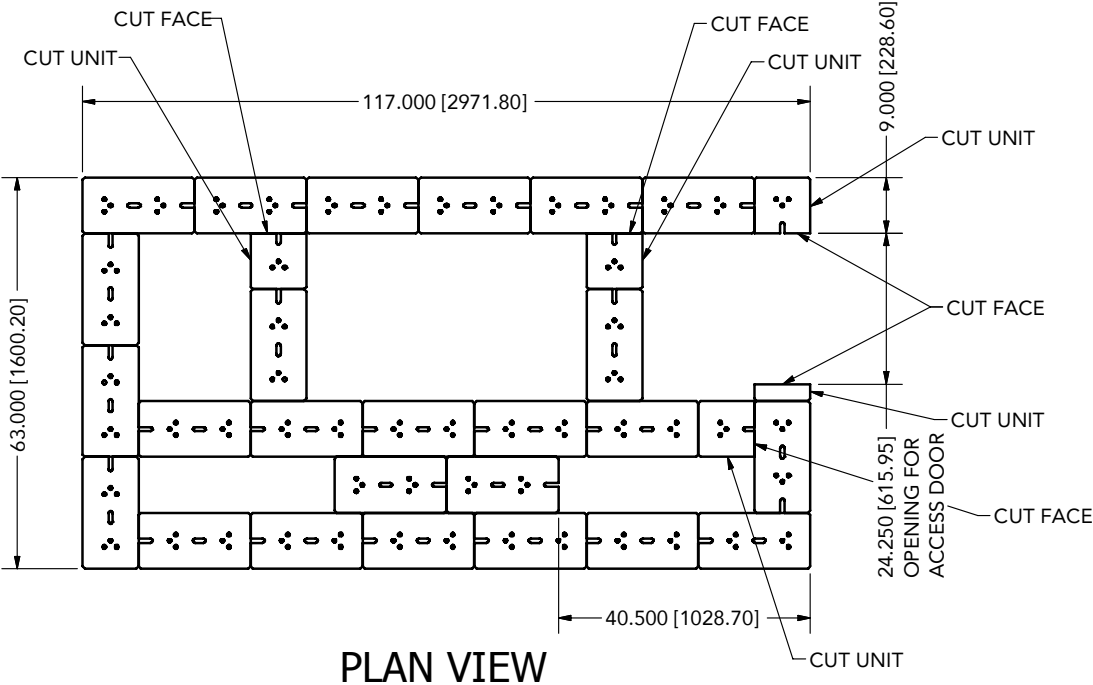

**PLAN VIEW**

NOTE:  
1. WALL UNITS TO BE INSTALLED WITH CHANNEL ON THE BOTTOM SIDE (PRODUCT IS TO BE INVERTED 180 DEGREES FROM FINISHED PALLET).

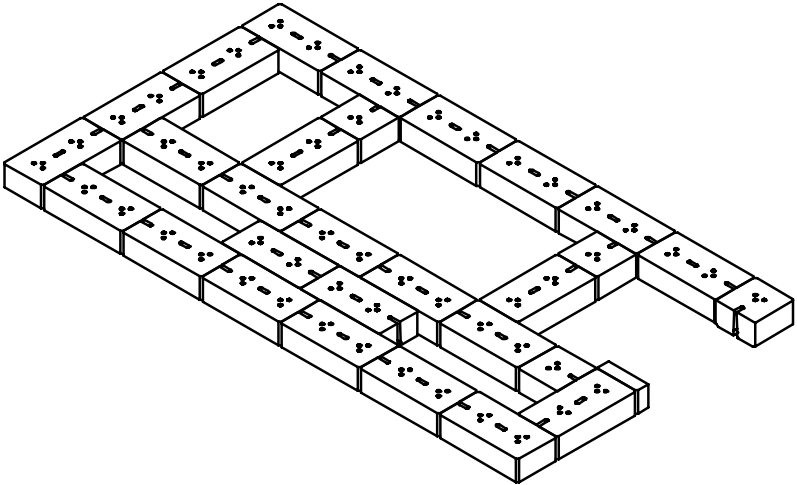

**ISOMETRIC VIEW**

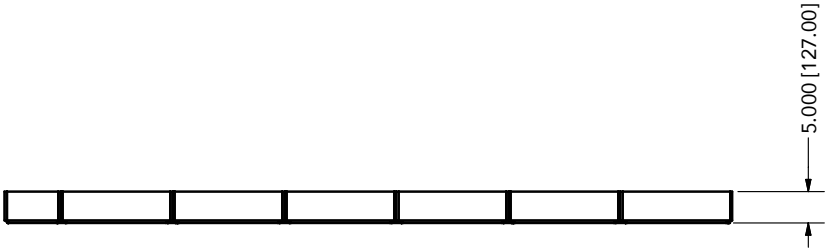

**FRONT ELEVATION VIEW**



**SIDE ELEVATION VIEW**

PRODUCT COUNTS:  
(30) TOTAL WALL UNITS

**LENZA - 63 x 117 FIREPLACE - RIGHT ACCESS DOOR DESIGN - 4th COURSE**

**LENZA - 63 x 117 FIREPLACE - RIGHT ACCESS DOOR DESIGN**

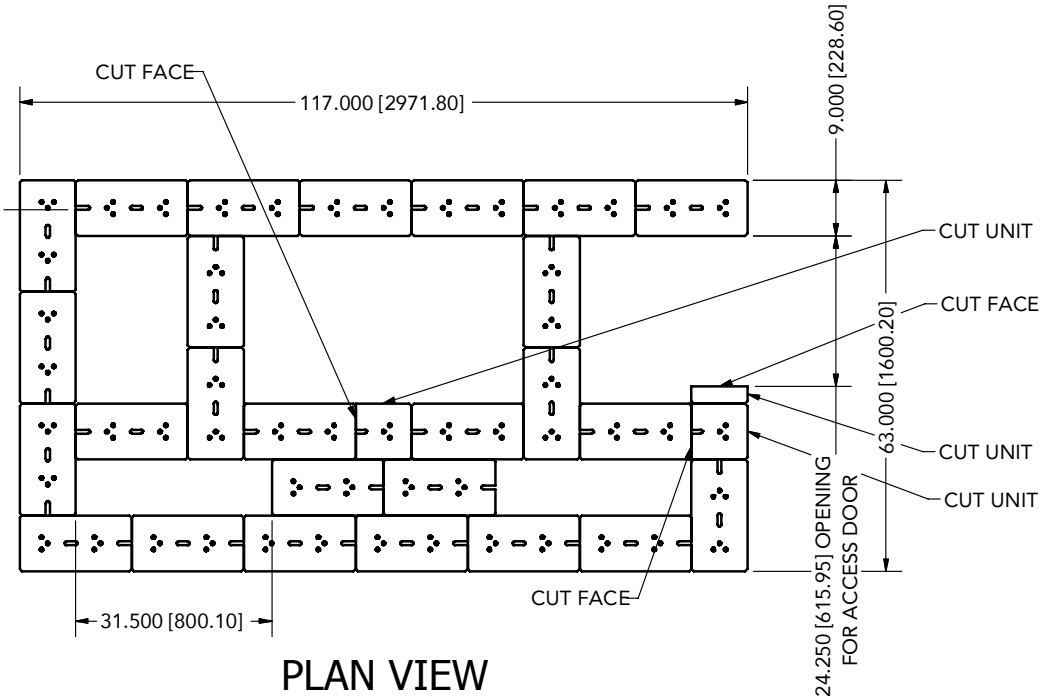

**PLAN VIEW**

NOTE:  
 1. WALL UNITS TO BE INSTALLED WITH CHANNEL ON THE BOTTOM SIDE  
 (PRODUCT IS TO BE INVERTED 180 DEGREES FROM FINISHED PALLET).

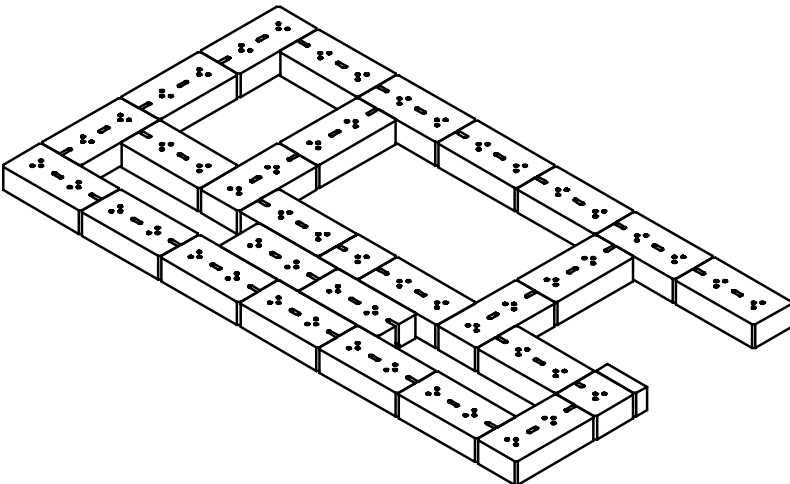

**ISOMETRIC VIEW**

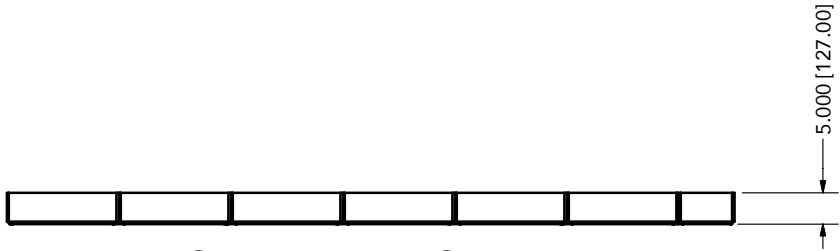

**FRONT ELEVATION VIEW**



**SIDE ELEVATION VIEW**

PRODUCT COUNTS:  
 (29) TOTAL CAP UNITS

**LENZA - 63 x 117 FIREPLACE - RIGHT ACCESS DOOR DESIGN - 5th COURSE**

# LENZA - 63 x 117 FIREPLACE - RIGHT ACCESS DOOR DESIGN

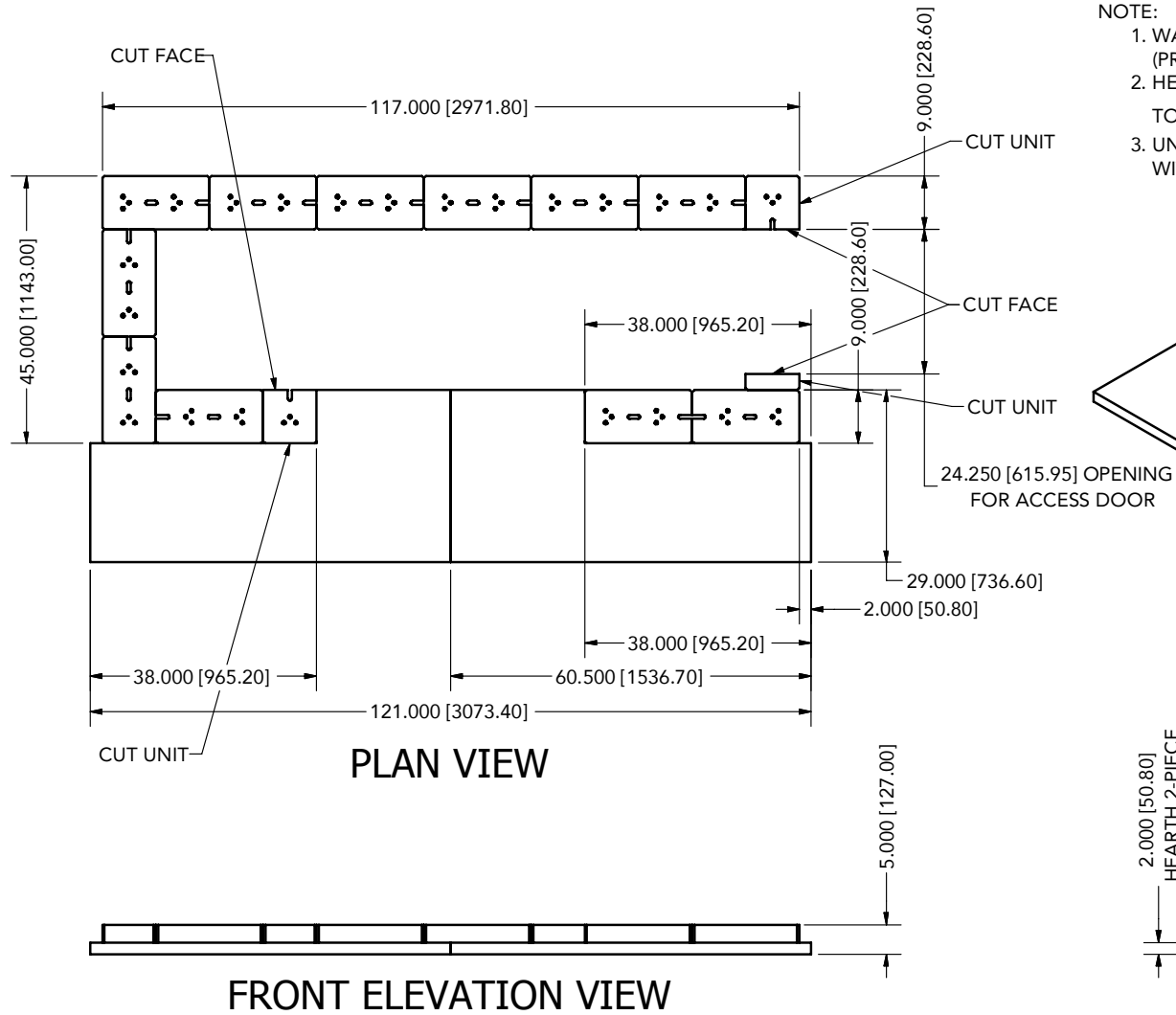

- NOTE:
1. WALL UNITS TO BE INSTALLED WITH CHANNEL ON THE BOTTOM SIDE (PRODUCT IS TO BE INVERTED 180 DEGREES FROM FINISHED PALLET).
  2. HEARTH PIECE IS TO BE MADE FROM THE SAME MATERIAL AS THE TOP, (2" ± THICK).
  3. UNLESS OTHERWISE DIRECTED INSTALL AND SECURE HEARTH PIECES WITH APPROVED ADHESIVE OR BONDING AGENT.

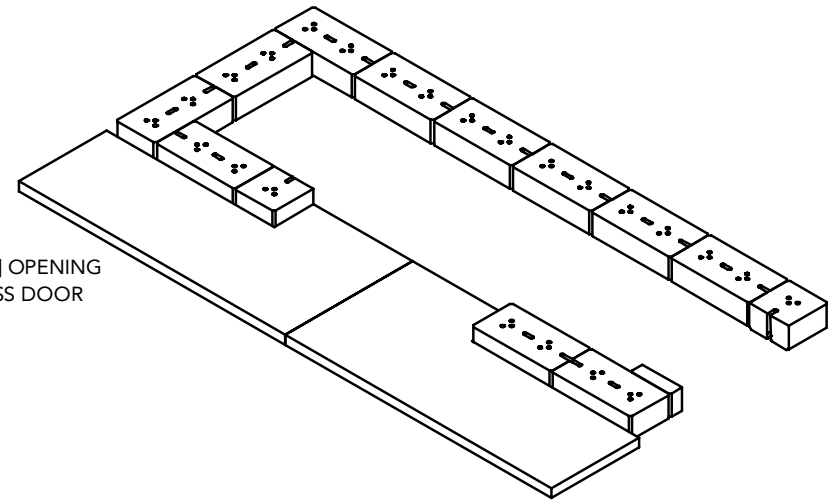

PRODUCT COUNTS:  
(14) TOTAL CAP UNITS

## LENZA - 63 x 117 FIREPLACE - RIGHT ACCESS DOOR DESIGN - 6th COURSE

NOTE:  
1. WALL UNITS TO BE INSTALLED WITH CHANNEL ON THE BOTTOM SIDE  
(PRODUCT IS TO BE INVERTED 180 DEGREES FROM FINISHED PALLET).

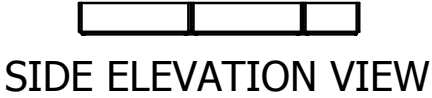
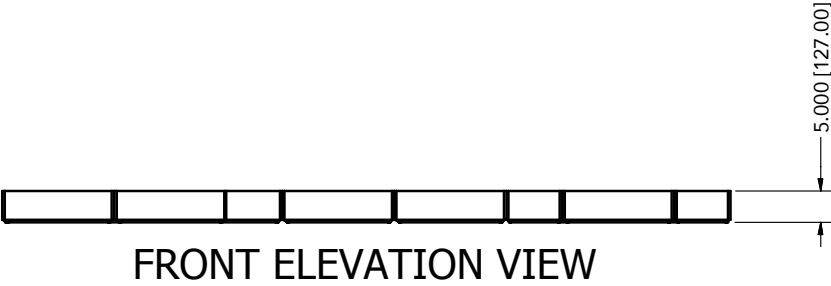
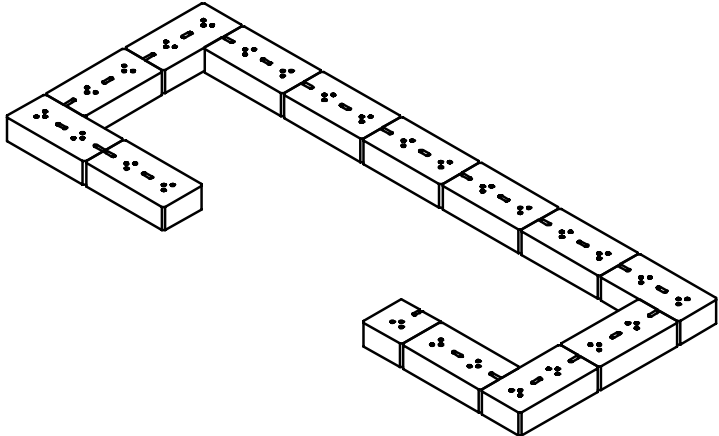
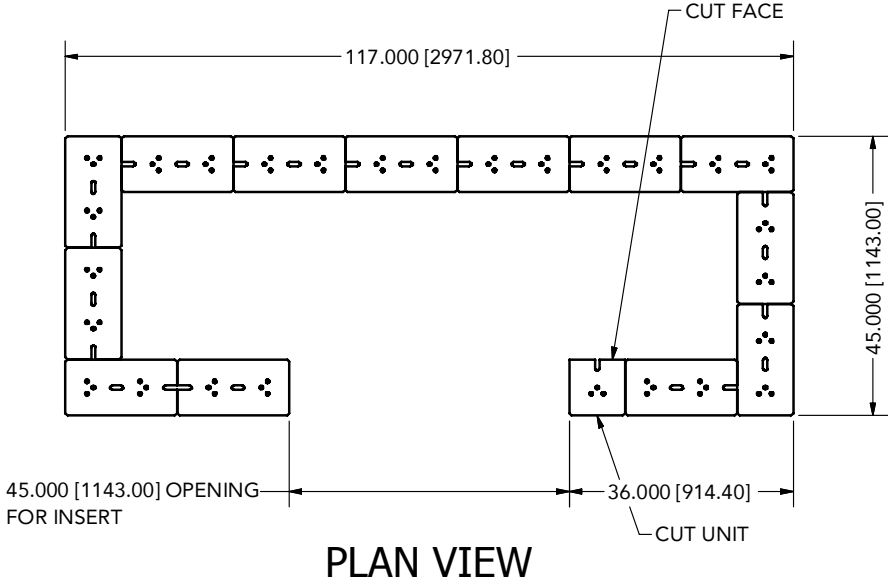

PRODUCT COUNTS:  
(14) TOTAL WALL UNITS

LENZA - 63 x 117 FIREPLACE - RIGHT ACCESS DOOR DESIGN - 7th, 9th & 11th COURSES

# LENZA - 63 x 117 FIREPLACE - RIGHT ACCESS DOOR DESIGN

## OUTDOOR LIVING DESIGNS

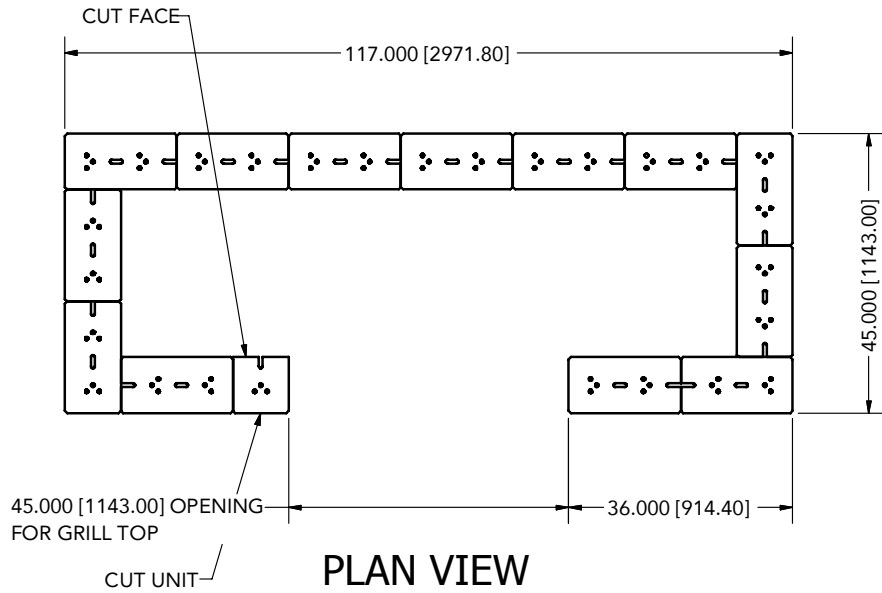

NOTE:

1. WALL UNITS TO BE INSTALLED WITH CHANNEL ON THE BOTTOM SIDE (PRODUCT IS TO BE INVERTED 180 DEGREES FROM FINISHED PALLET).

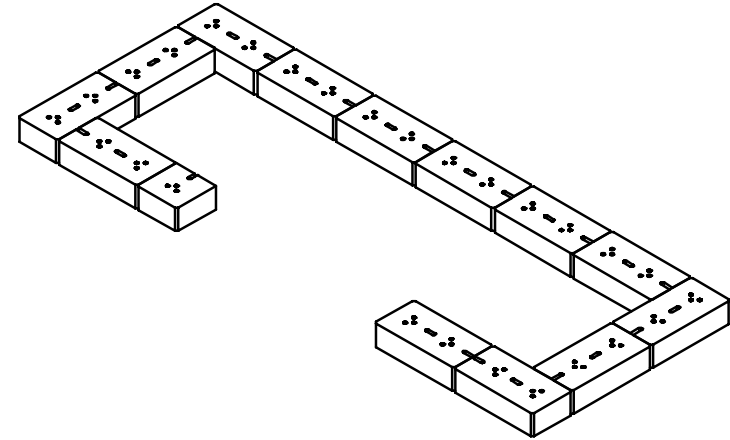

ISOMETRIC VIEW

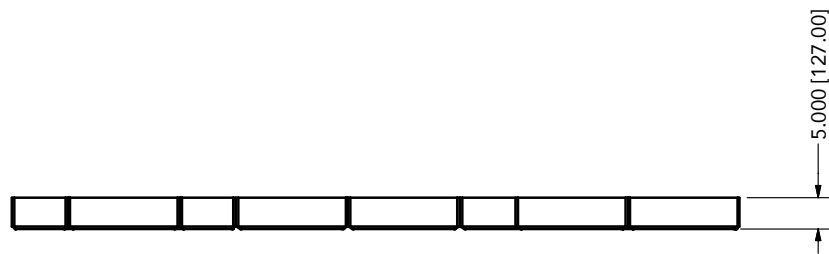

FRONT ELEVATION VIEW

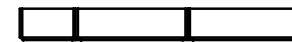

SIDE ELEVATION VIEW

PRODUCT COUNTS:  
(14) TOTAL WALL UNITS

LENZA - 63 x 117 FIREPLACE - RIGHT ACCESS DOOR DESIGN - 8th, 10th & 12th COURSES

# LENZA - 63 x 117 FIREPLACE - RIGHT ACCESS DOOR DESIGN

NOTE:  
1. WALL UNITS TO BE INSTALLED WITH CHANNEL ON THE BOTTOM SIDE  
(PRODUCT IS TO BE INVERTED 180 DEGREES FROM FINISHED PALLET).

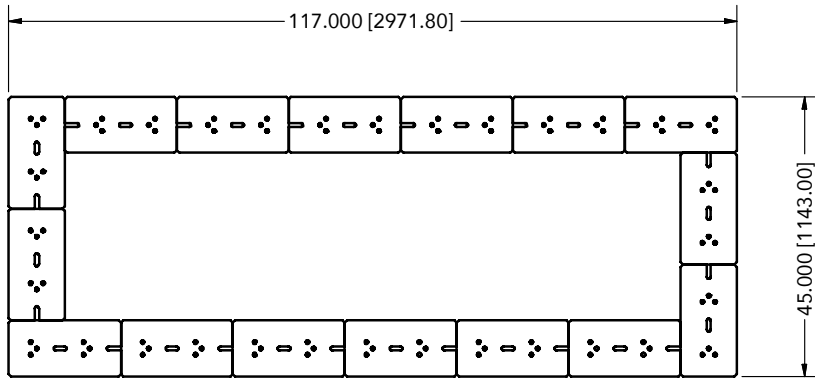

PLAN VIEW

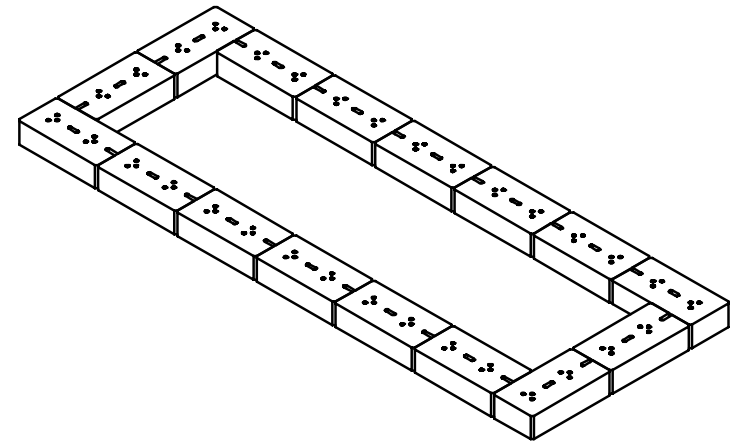

ISOMETRIC VIEW

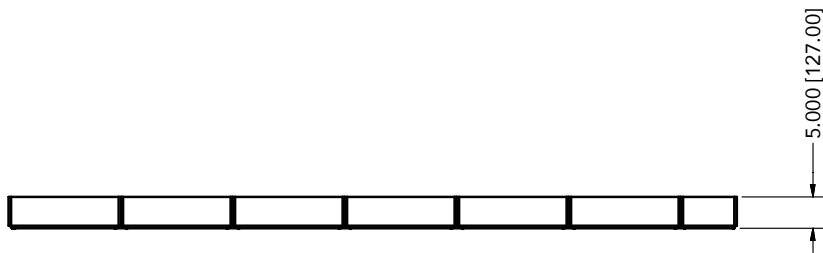

FRONT ELEVATION VIEW



SIDE ELEVATION VIEW

PRODUCT COUNTS:  
(16) TOTAL WALL UNITS

**LENZA - 63 x 117 FIREPLACE - RIGHT ACCESS DOOR DESIGN - 12th COURSE**

NOTE:  
1. UNLESS OTHERWISE DIRECTED INSTALL AND SECURE COUNTERTOP WITH APPROVED ADHESIVE OR BONDING AGENT.

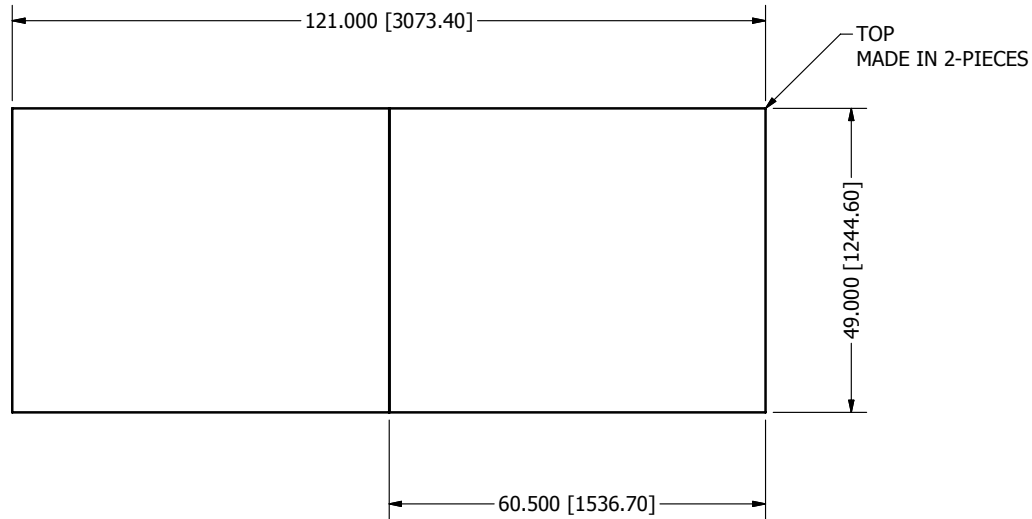

**PLAN VIEW**

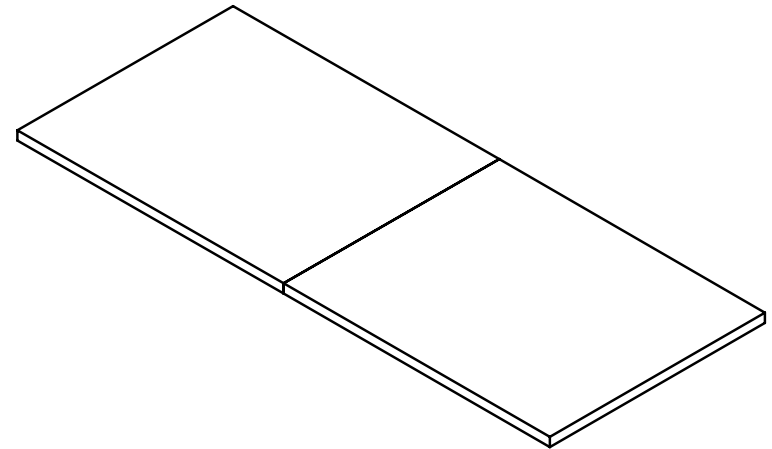

**ISOMETRIC VIEW**

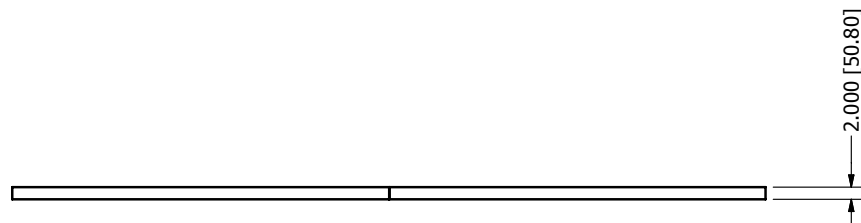

**FRONT ELEVATION VIEW**

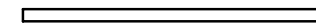

**SIDE ELEVATION VIEW**

**LENZA - 63 x 117 FIREPLACE - RIGHT ACCESS DOOR DESIGN - TOP COURSE**