

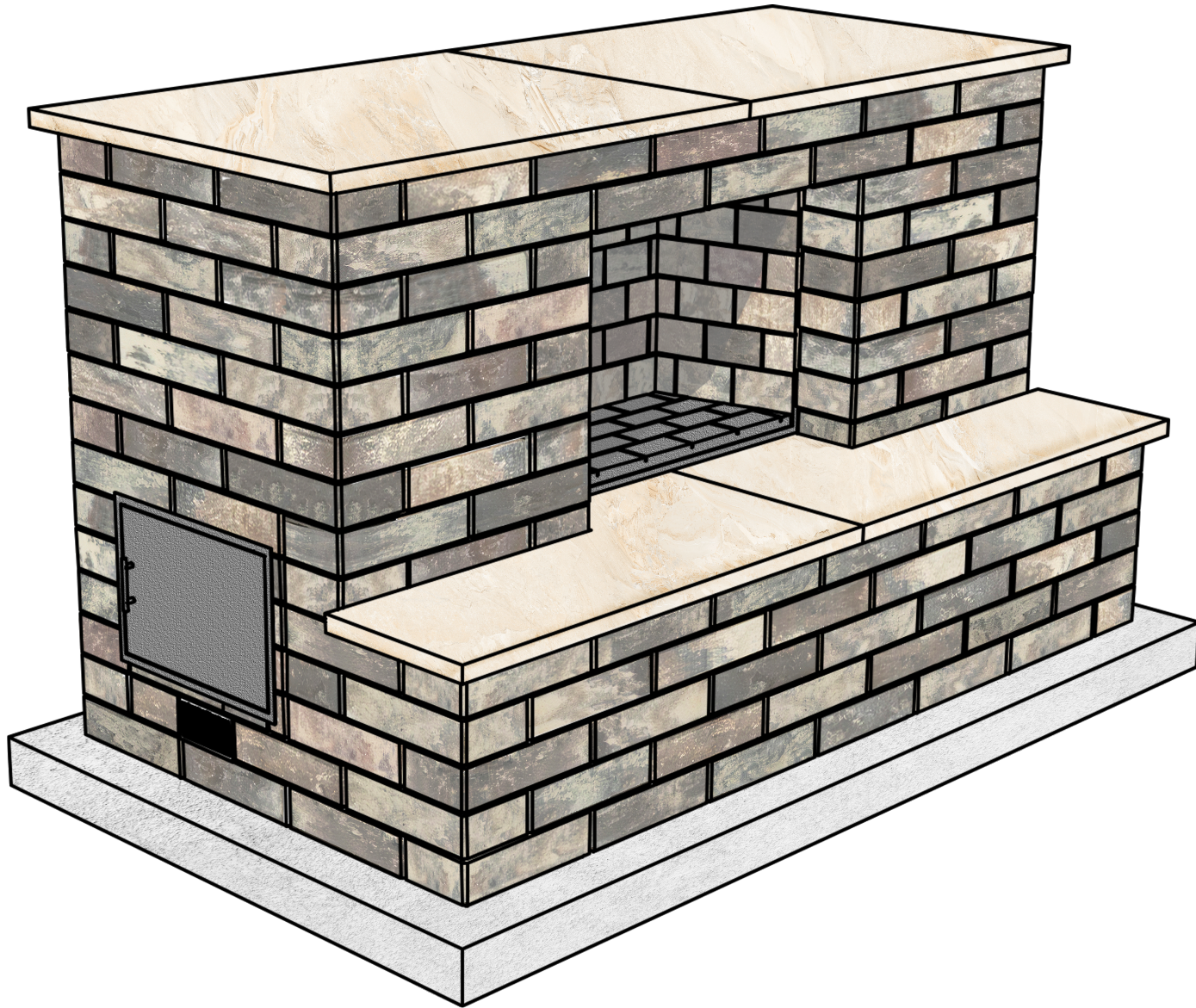

**oberfields**<sup>TM</sup>

**A QUIKRETE® COMPANY**



# LENZA

63 x 117 FIREPLACE - LEFT ACCESS DOOR DESIGN

# LENZA - 63 x 117 FIREPLACE - LEFT ACCESS DOOR DESIGN

**NOTE:**

1. WALL UNITS TO BE INSTALLED WITH CHANNEL ON THE BOTTOM SIDE IN ORDER TO GET THE PROPER CONTEMPORARY ESTHETIC LOOK. (WALL PRODUCT TO BE INVERTED 180 DEGREES FROM FINISHED PALLET WHEN INSTALLED).
2. SECURE EACH UNIT USING APPROVED ADHESIVE OR BONDING AGENT FOLLOWING APPLICATION DIRECTIONS PROVIDED BY PRODUCT SUPPLIER.
3. THIS DESIGN REQUIRES CUTTING UNITS TO PROPERLY FIT THE INSERT AND ACCESS DOOR.
4. BUILT-IN INSERT AND ACCESS DOOR TO BE INSTALLED PER MANUFACTURES RECOMMENDATIONS.
5. STRUCTURAL SUPPORT FOR BLOCK UNITS OVER OPENINGS NOT SHOWN FOR VISUAL PURPOSES.
6. FOR VENT FREE SERIES (GAS ONLY) INFORMATION SEE EARTHCORE 46" VENT-FREE GENERAL INFORMATION AND SPECIFICATIONS.

EARTHCORE INSERT VENT-FREE  
46-INCH PART# 81046 (STOCK)

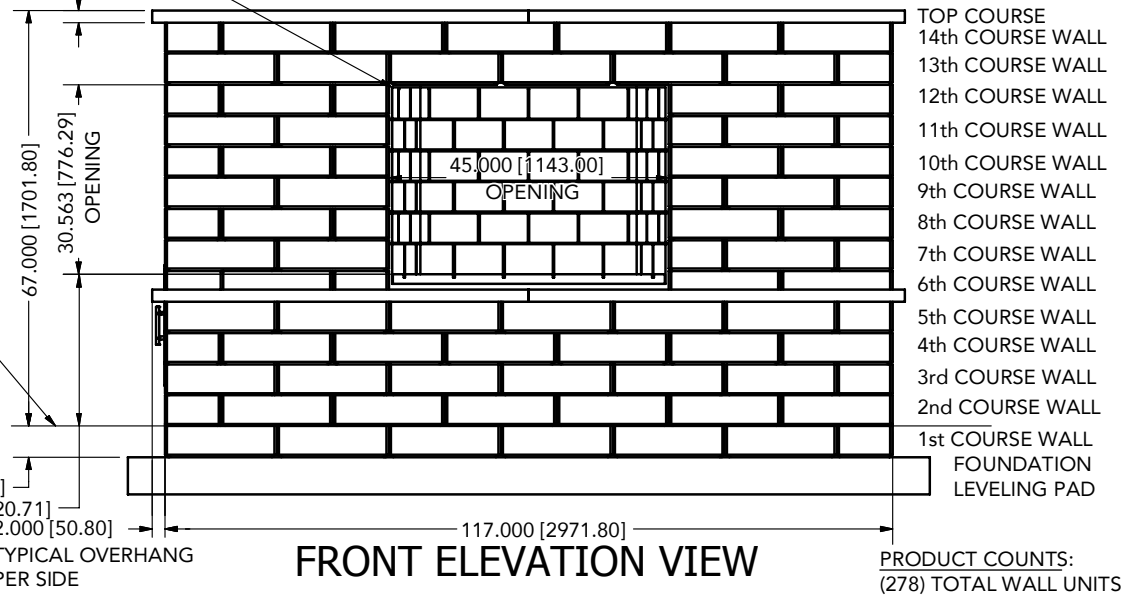
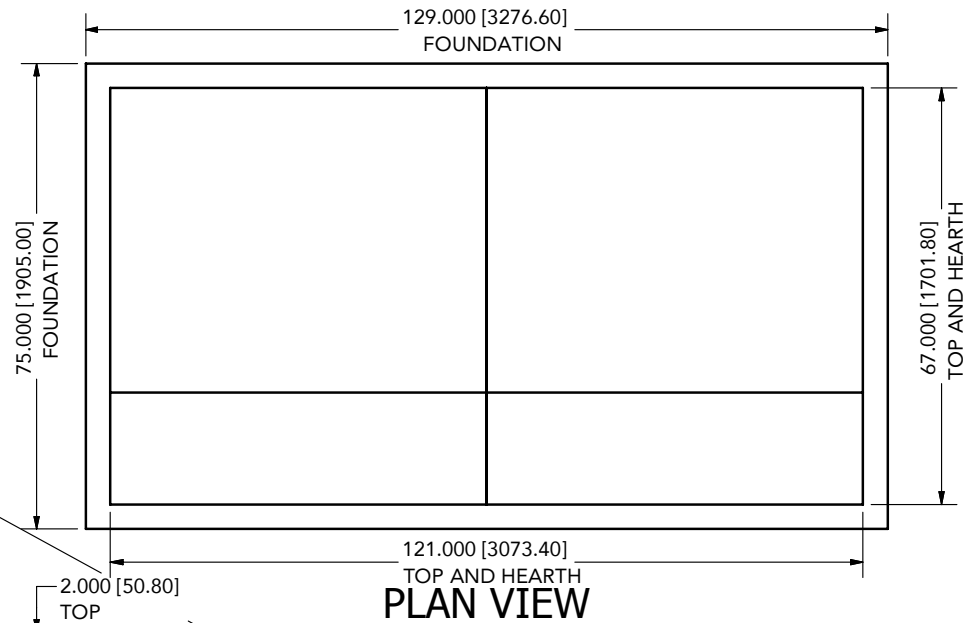
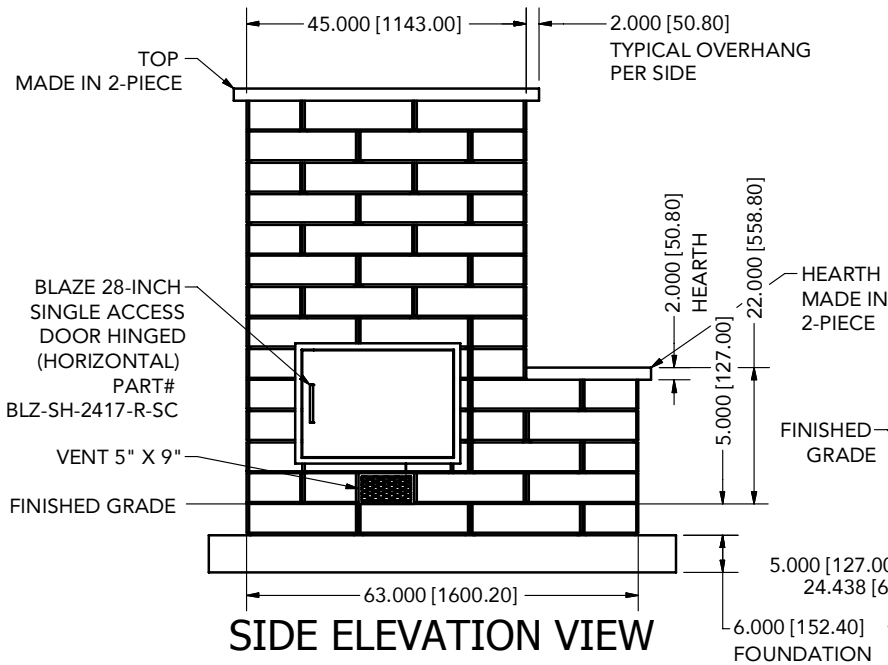

# LENZA - 63 x 117 FIREPLACE - LEFT ACCESS DOOR DESIGN

OUTDOOR LIVING DESIGNS

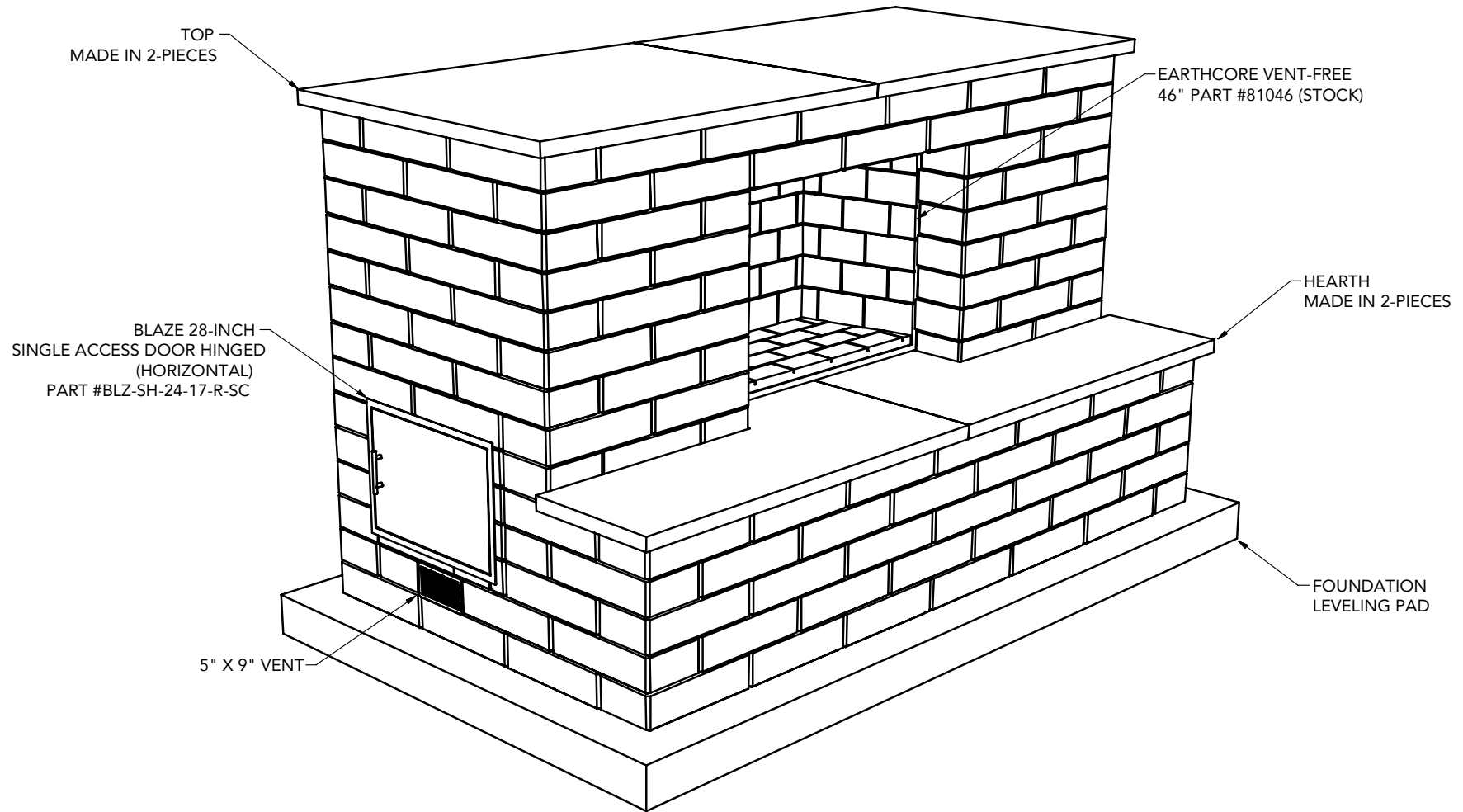

ISOMETRIC VIEW

LENZA - 63 x 117 FIREPLACE - LEFT ACCESS DOOR DESIGN - ISOMETRIC VIEW

# LENZA - 63 x 117 FIREPLACE - LEFT ACCESS DOOR DESIGN

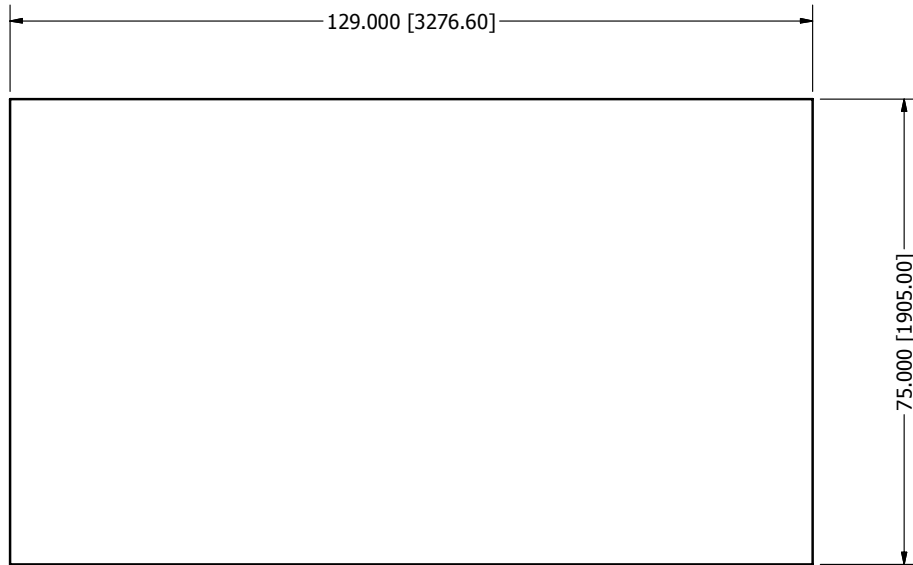

PLAN VIEW

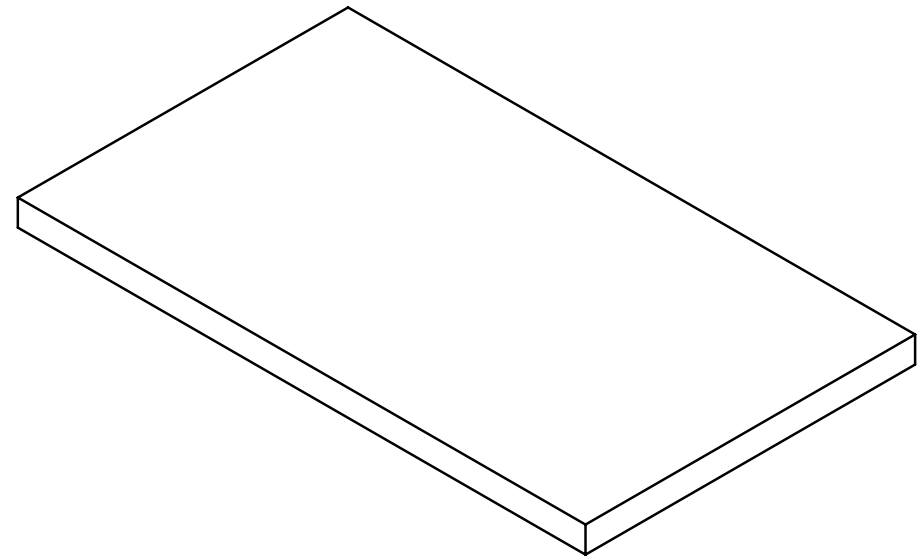

ISOMETRIC VIEW

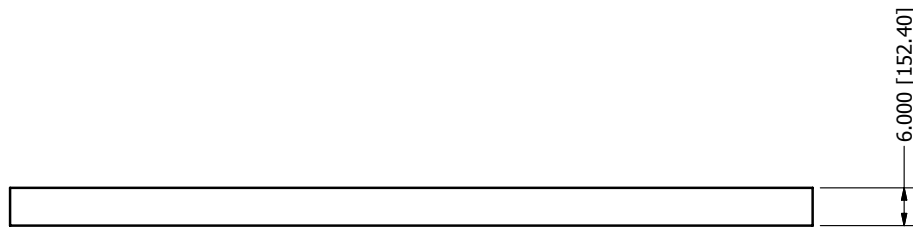

FRONT ELEVATION VIEW



SIDE ELEVATION VIEW

LENZA - 63 x 117 FIREPLACE - LEFT ACCESS DOOR DESIGN - FOUNDATION LEVELING PAD

# LENZA - 63 x 117 FIREPLACE - LEFT ACCESS DOOR DESIGN

NOTE:

1. WALL UNITS TO BE INSTALLED WITH CHANNEL ON THE BOTTOM SIDE (PRODUCT IS TO BE INVERTED 180 DEGREES FROM FINISHED PALLET).

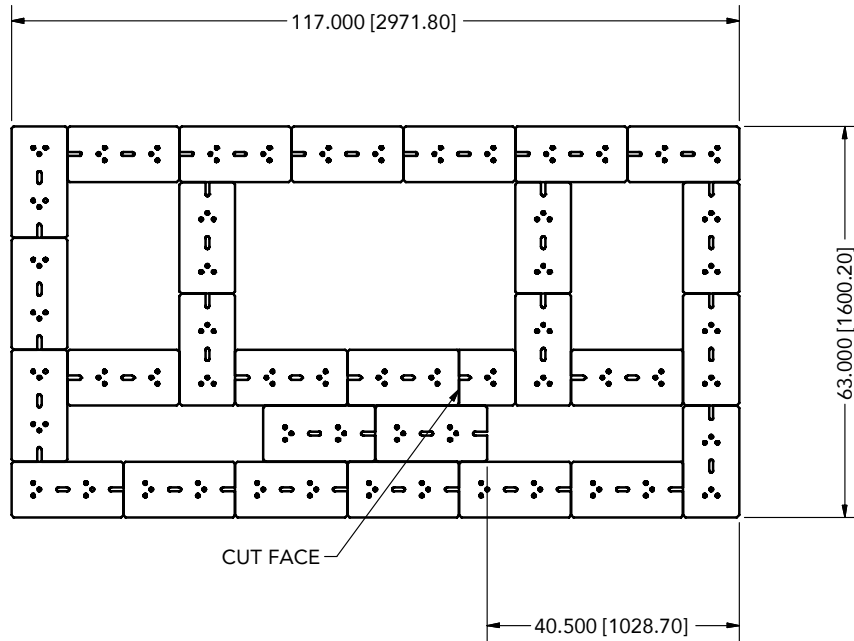

PLAN VIEW

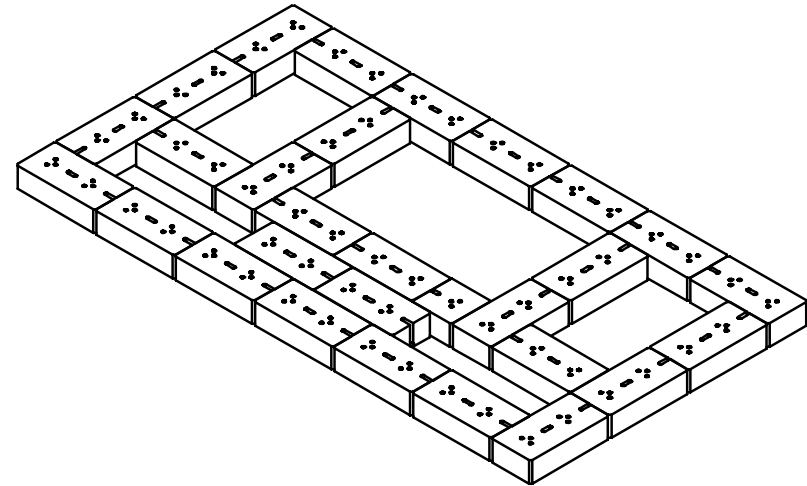

ISOMETRIC VIEW



FRONT ELEVATION VIEW

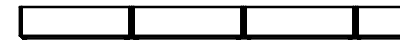

SIDE ELEVATION VIEW

PRODUCT COUNTS:  
(28) TOTAL WALL UNITS

LENZA - 63 x 117 FIREPLACE - LEFT ACCESS DOOR DESIGN - 1st COURSE

# LENZA - 63 x 117 FIREPLACE - LEFT ACCESS DOOR DESIGN

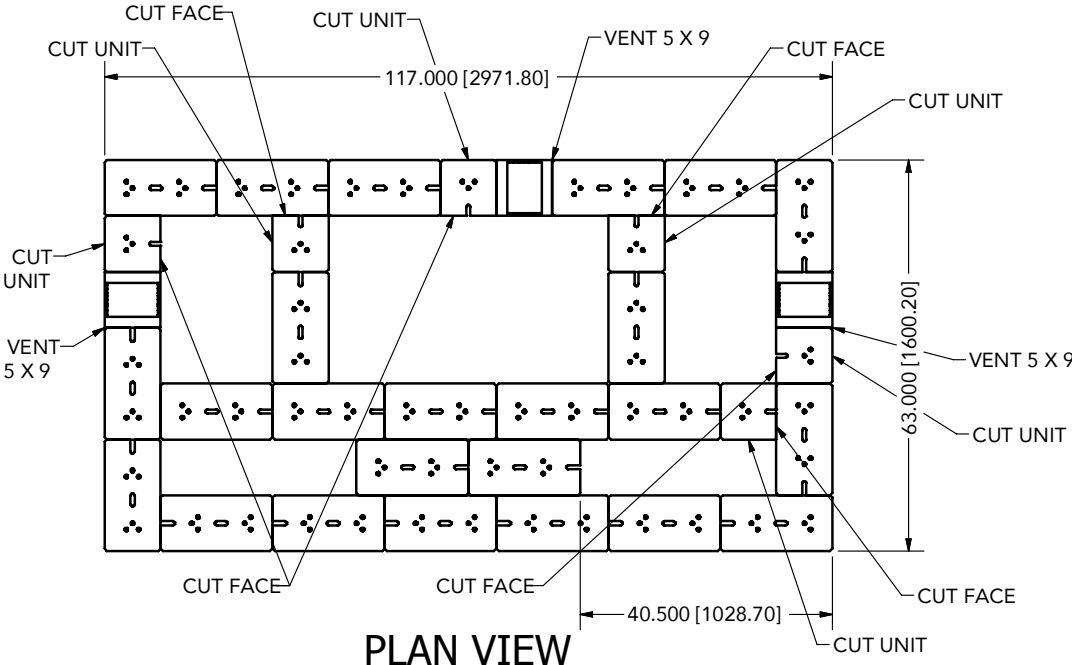

PLAN VIEW

NOTE:  
1. WALL UNITS TO BE INSTALLED WITH CHANNEL ON THE BOTTOM SIDE (PRODUCT IS TO BE INVERTED 180 DEGREES FROM FINISHED PALLET).

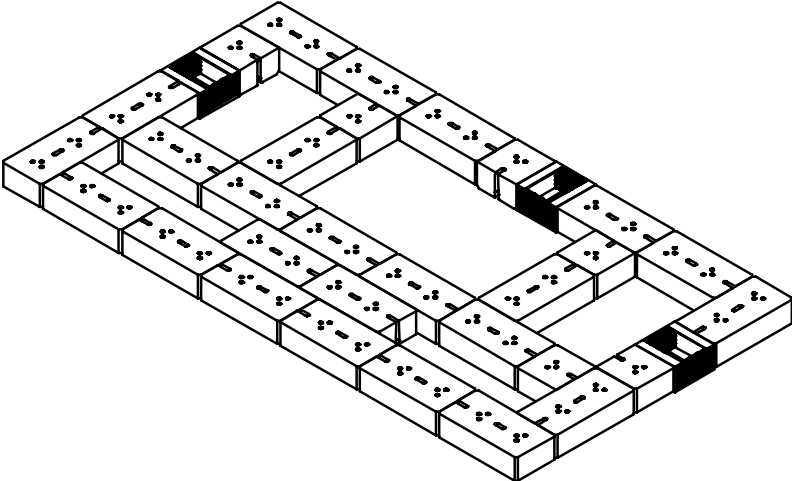

ISOMETRIC VIEW

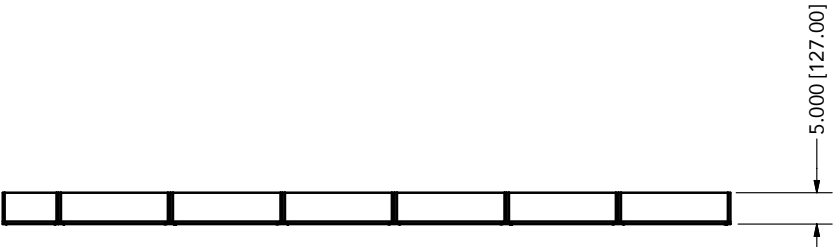

FRONT ELEVATION VIEW



SIDE ELEVATION VIEW

PRODUCT COUNTS:  
(30) TOTAL WALL UNITS

## LENZA - 63 x 117 FIREPLACE - LEFT ACCESS DOOR DESIGN - 2nd COURSE

# LENZA - 63 x 117 FIREPLACE - LEFT ACCESS DOOR DESIGN

**NOTE:**

1. WALL UNITS TO BE INSTALLED WITH CHANNEL ON THE BOTTOM SIDE (PRODUCT IS TO BE INVERTED 180 DEGREES FROM FINISHED PALLET).

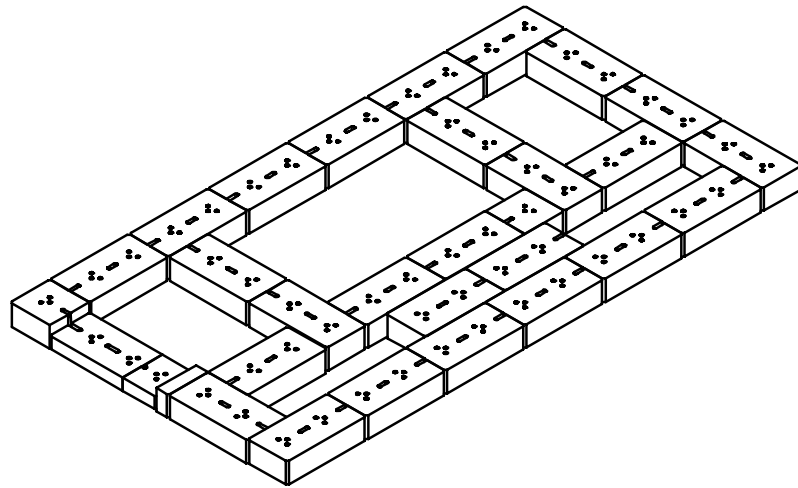

ISOMETRIC VIEW

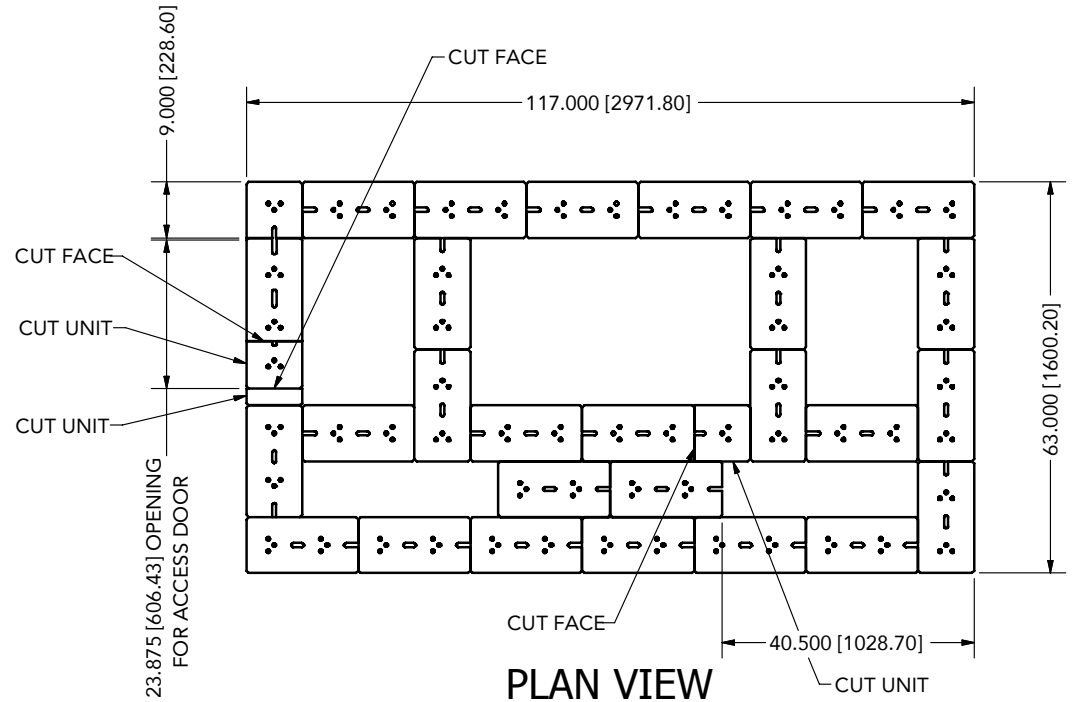

PLAN VIEW

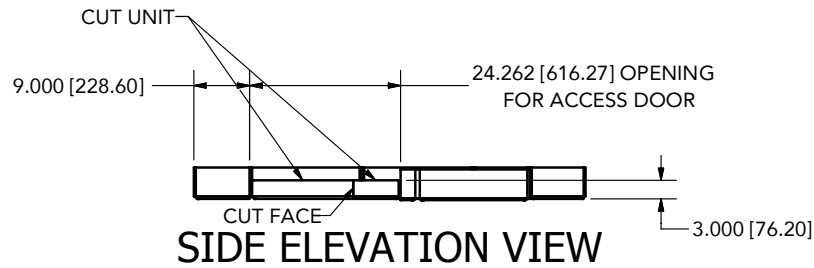

SIDE ELEVATION VIEW

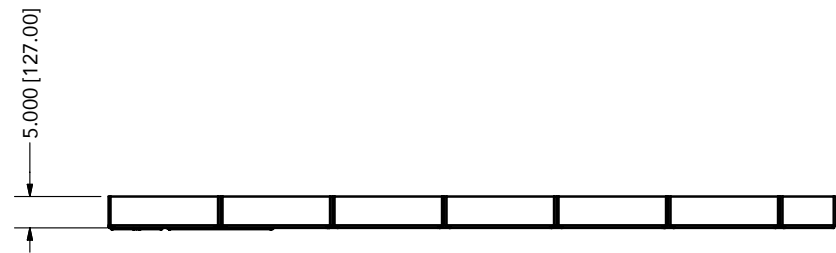

FRONT ELEVATION VIEW

PRODUCT COUNTS:  
(31) TOTAL WALL UNITS

## LENZA - 63 x 117 FIREPLACE - LEFT ACCESS DOOR DESIGN - 3rd COURSE

# LENZA - 63 x 117 FIREPLACE - LEFT ACCESS DOOR DESIGN

NOTE:  
 1. WALL UNITS TO BE INSTALLED WITH CHANNEL ON THE BOTTOM SIDE  
 (PRODUCT IS TO BE INVERTED 180 DEGREES FROM FINISHED PALLET).

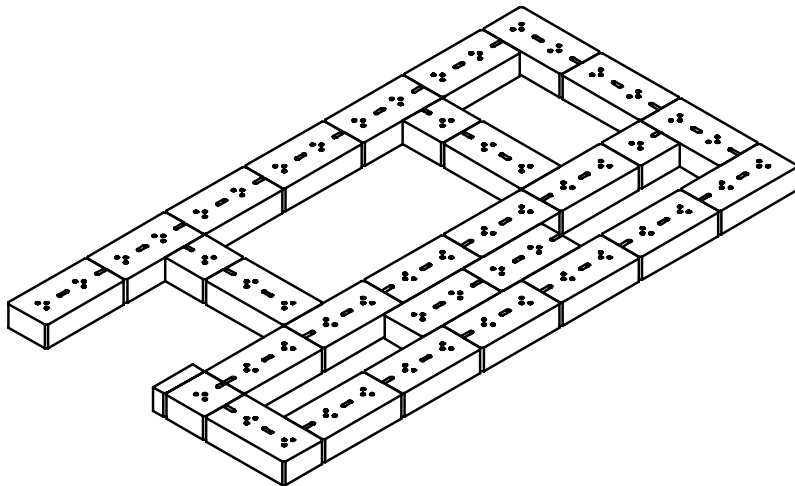

ISOMETRIC VIEW

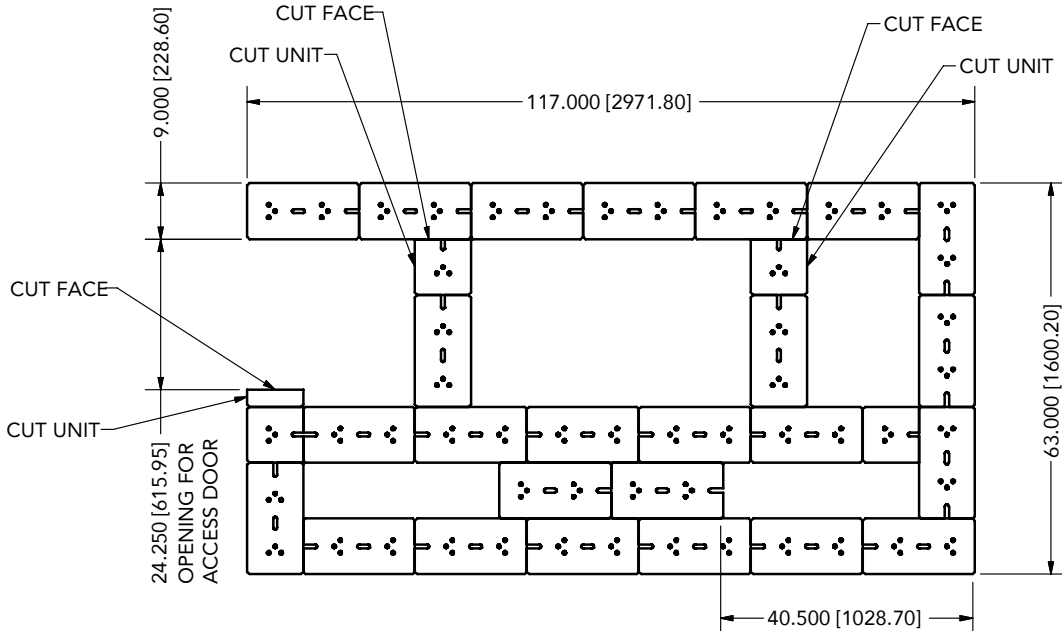

PLAN VIEW



SIDE ELEVATION VIEW

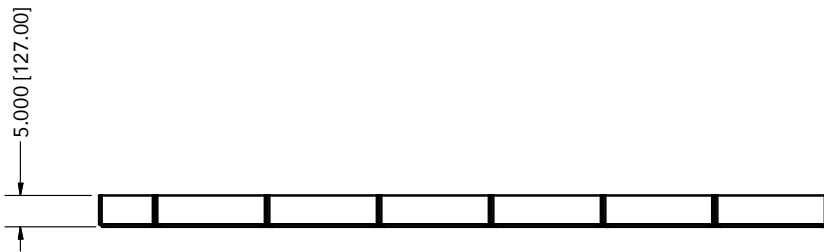

FRONT ELEVATION VIEW

PRODUCT COUNTS:  
 (30) TOTAL WALL UNITS

## LENZA - 63 x 117 FIREPLACE - LEFT ACCESS DOOR DESIGN - 4th COURSE



# LENZA - 63 x 117 FIREPLACE - LEFT ACCESS DOOR DESIGN

- NOTE:
1. WALL UNITS TO BE INSTALLED WITH CHANNEL ON THE BOTTOM SIDE (PRODUCT IS TO BE INVERTED 180 DEGREES FROM FINISHED PALLET).
  2. HEARTH PIECE IS TO BE MADE FROM THE SAME MATERIAL AS THE TOP, (2" ± THICK).
  3. UNLESS OTHERWISE DIRECTED INSTALL AND SECURE HEARTH PIECES WITH APPROVED ADHESIVE OR BONDING AGENT.

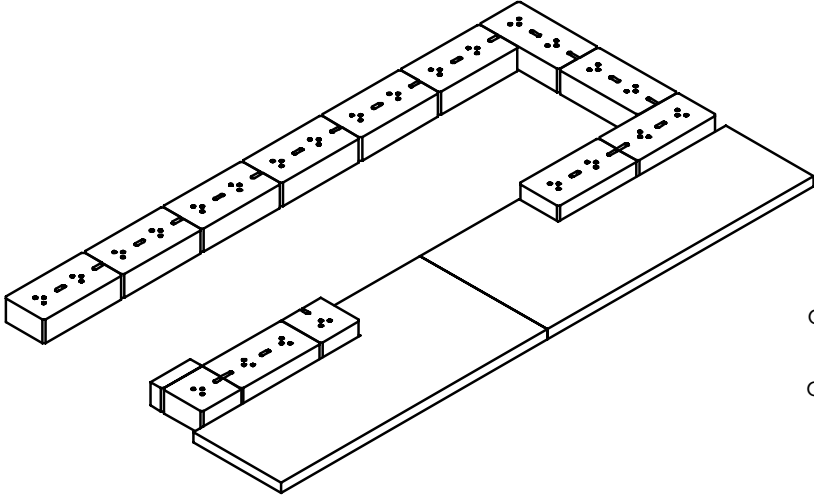

ISOMETRIC VIEW

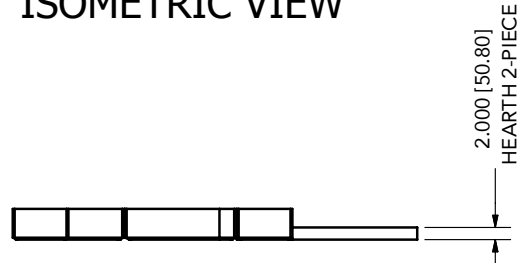

SIDE ELEVATION VIEW

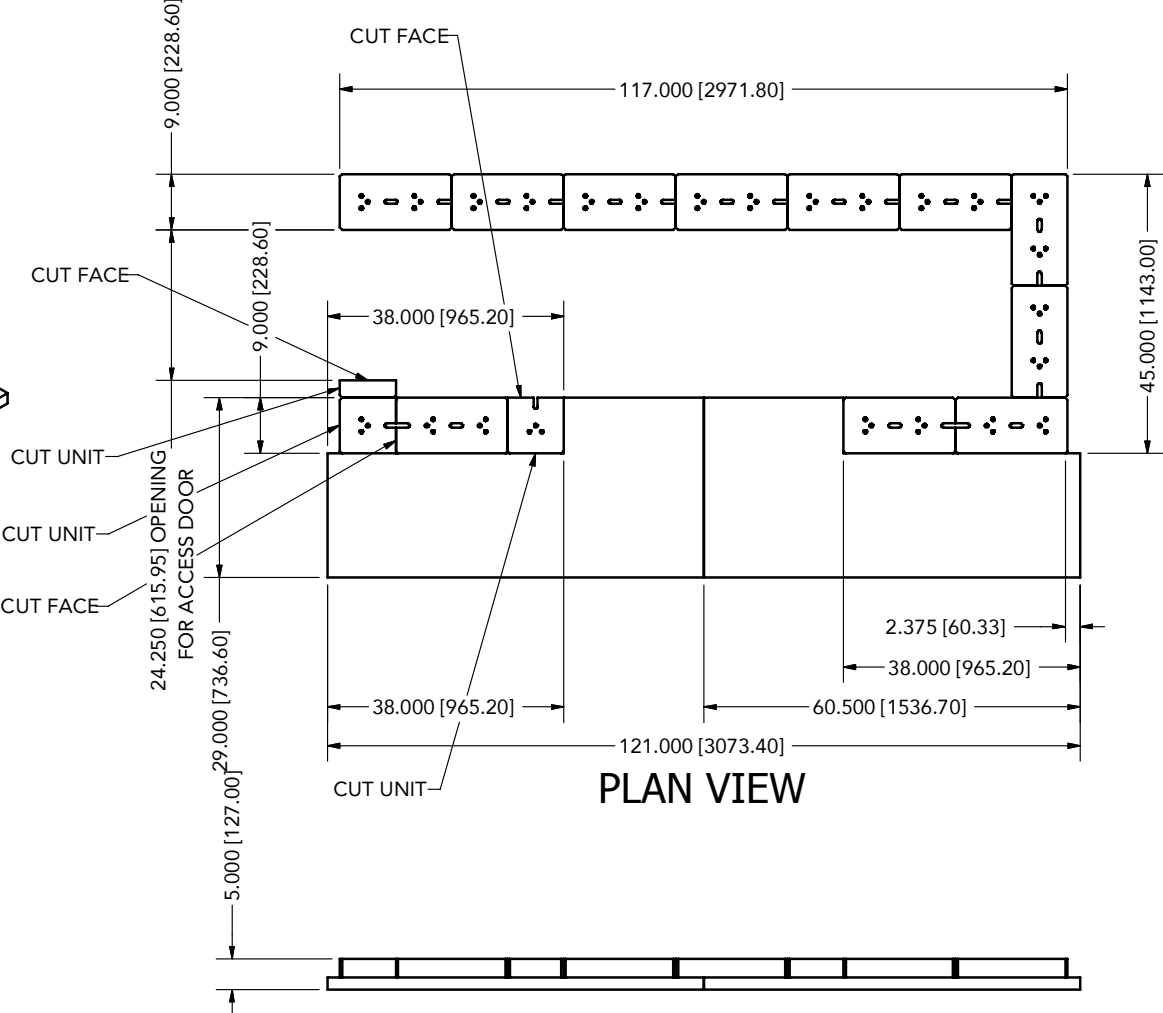

PLAN VIEW

FRONT ELEVATION VIEW

PRODUCT COUNTS:  
(14) TOTAL CAP UNITS

## LENZA - 63 x 117 FIREPLACE - LEFT ACCESS DOOR DESIGN - 6th COURSE

**LENZA - 63 x 117 FIREPLACE - LEFT ACCESS DOOR DESIGN**

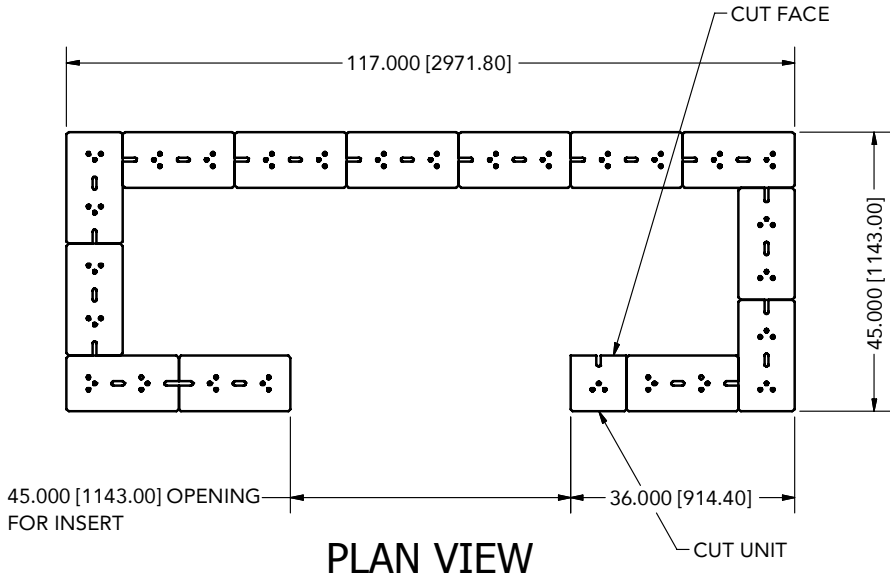

NOTE:  
 1. WALL UNITS TO BE INSTALLED WITH CHANNEL ON THE BOTTOM SIDE  
 (PRODUCT IS TO BE INVERTED 180 DEGREES FROM FINISHED PALLET).

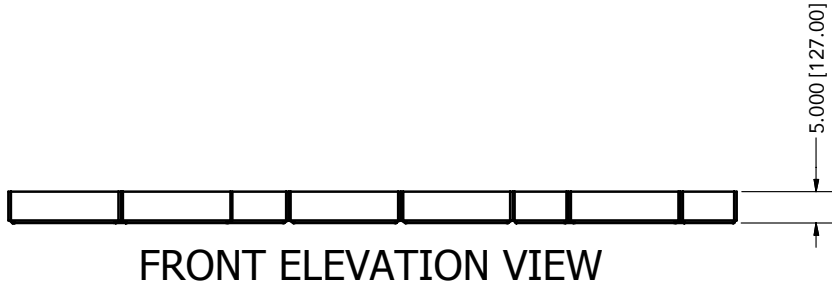
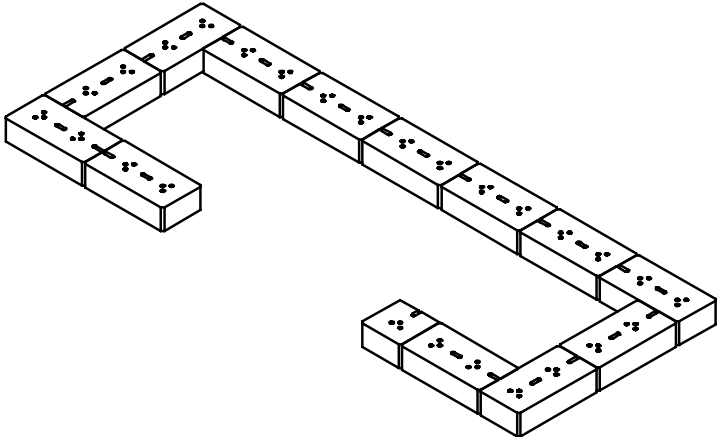

PRODUCT COUNTS:  
 (14) TOTAL WALL UNITS

**LENZA - 63 x 117 FIREPLACE - LEFT ACCESS DOOR DESIGN - 7th, 9th & 11th COURSES**

**LENZA - 63 x 117 FIREPLACE - LEFT ACCESS DOOR DESIGN**

NOTE:  
 1. WALL UNITS TO BE INSTALLED WITH CHANNEL ON THE BOTTOM SIDE  
 (PRODUCT IS TO BE INVERTED 180 DEGREES FROM FINISHED PALLET).

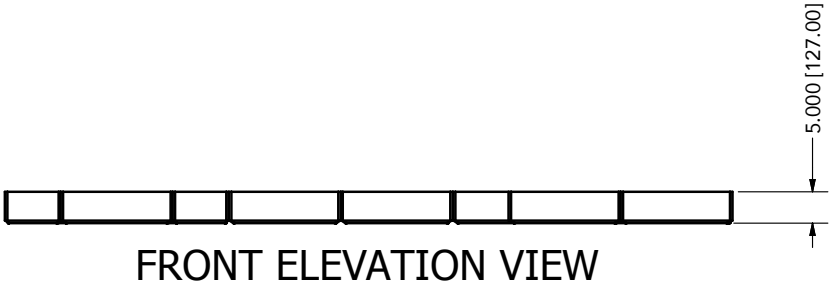
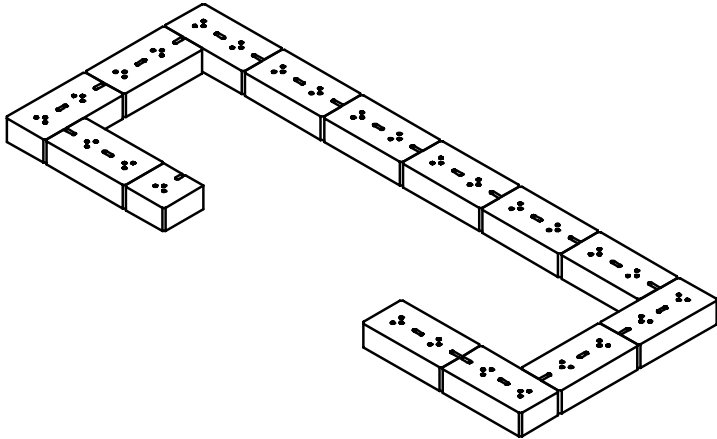
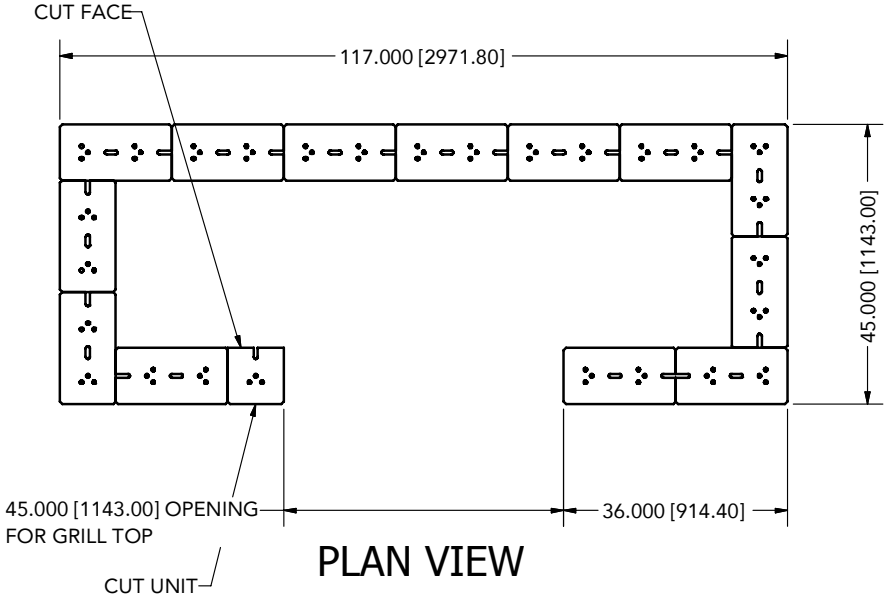

PRODUCT COUNTS:  
 (14) TOTAL WALL UNITS

**LENZA - 63 x 117 FIREPLACE - LEFT ACCESS DOOR DESIGN - 8th, 10th AND 12th COURSES**

# LENZA - 63 x 117 FIREPLACE - LEFT ACCESS DOOR DESIGN

NOTE:

- 1. WALL UNITS TO BE INSTALLED WITH CHANNEL ON THE BOTTOM SIDE (PRODUCT IS TO BE INVERTED 180 DEGREES FROM FINISHED PALLET).

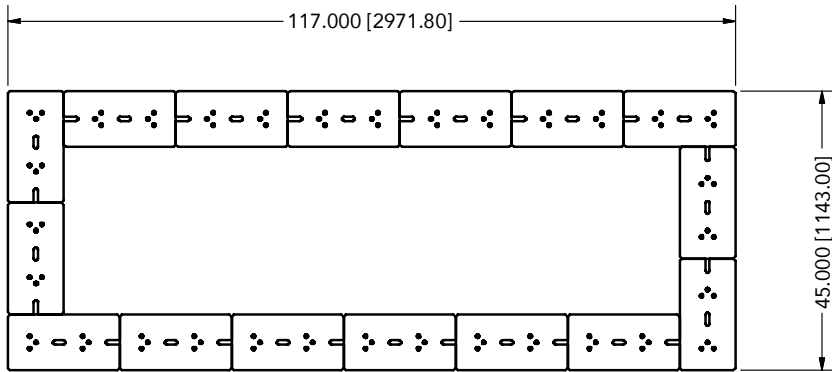

PLAN VIEW

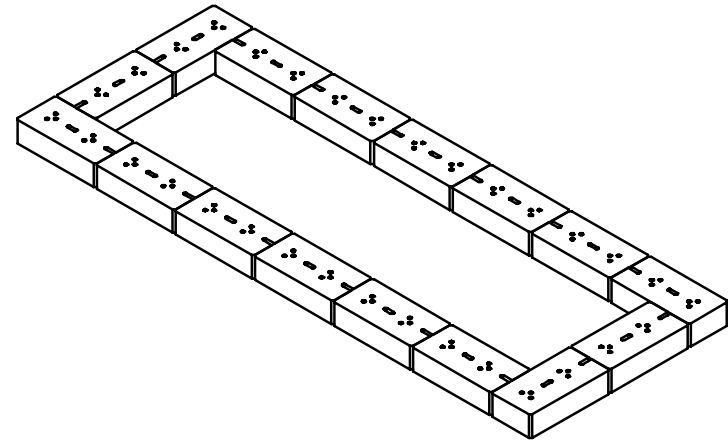

ISOMETRIC VIEW

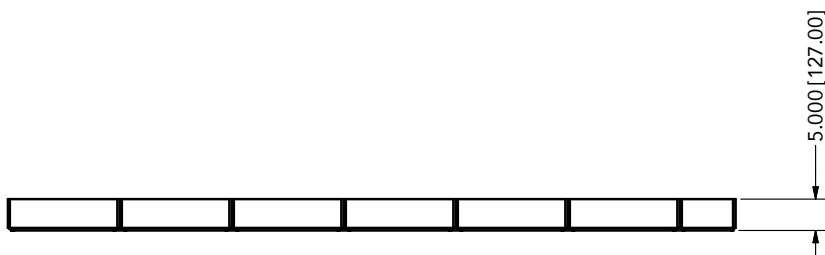

FRONT ELEVATION VIEW



SIDE ELEVATION VIEW

PRODUCT COUNTS:  
(16) TOTAL WALL UNITS

LENZA - 63 x 117 FIREPLACE - LEFT ACCESS DOOR DESIGN - 13th COURSE

NOTE:  
1. WALL UNITS TO BE INSTALLED WITH CHANNEL ON THE BOTTOM SIDE  
(PRODUCT IS TO BE INVERTED 180 DEGREES FROM FINISHED PALLET).

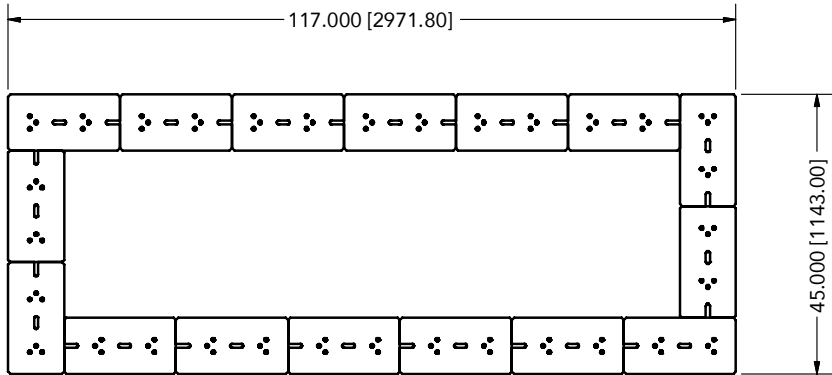

PLAN VIEW

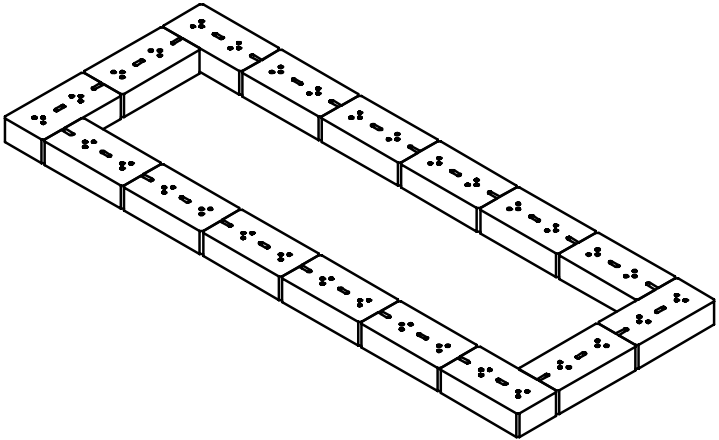

ISOMETRIC VIEW



FRONT ELEVATION VIEW

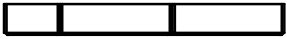

SIDE ELEVATION VIEW

PRODUCT COUNTS:  
(16) TOTAL WALL UNITS

LENZA - 63 x 117 FIREPLACE - LEFT ACCESS DOOR DESIGN - 14th COURSE

# LENZA - 63 x 117 FIREPLACE - LEFT ACCESS DOOR DESIGN

NOTE:  
1. UNLESS OTHERWISE DIRECTED INSTALL AND SECURE TOP WITH APPROVED ADHESIVE OR BONDING AGENT.

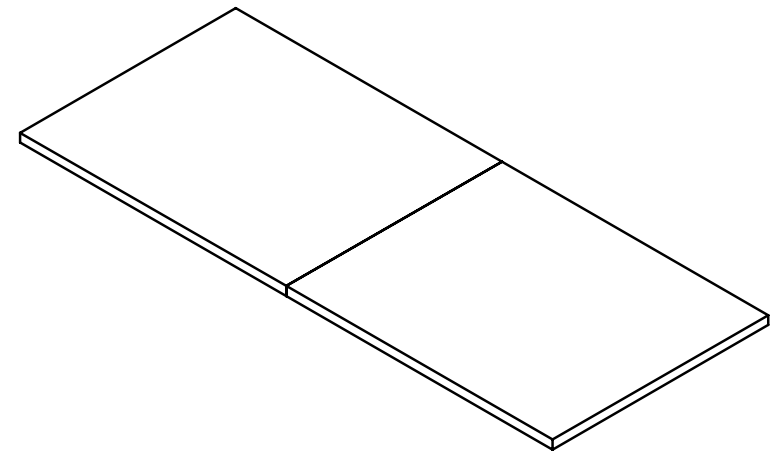
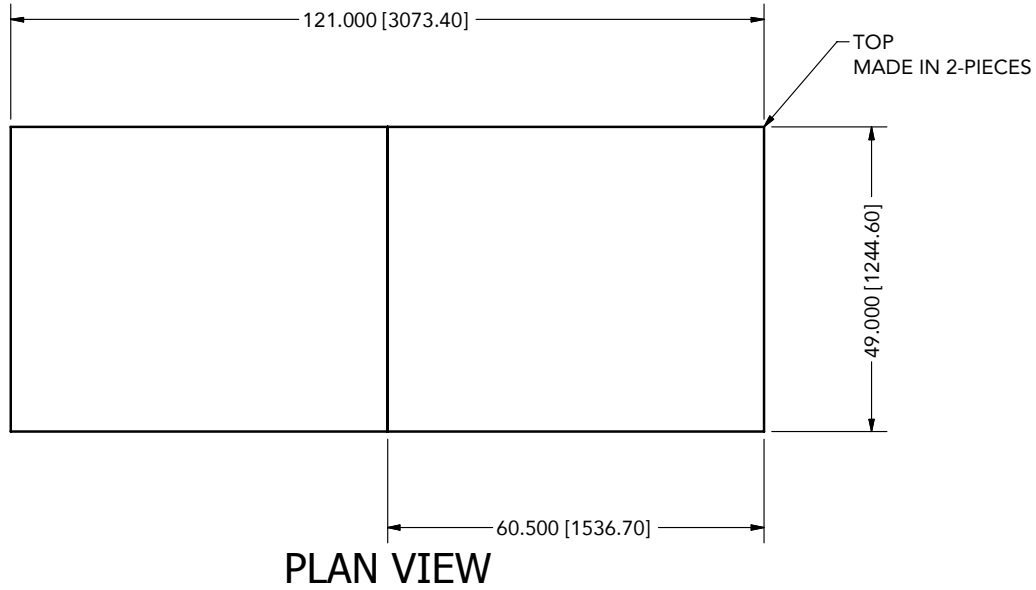

LENZA - 63 x 117 FIREPLACE - LEFT ACCESS DOOR DESIGN - TOP COURSE